

Data Sheet

Millipore Express® PHF Hydrophilic Filters

Sterilizing-grade PES filters for fast, efficient, and economical buffer and process intermediate filtration

Millipore Express® PHF (Process protection, High-Flux) devices provide sterilizing-grade performance, ideal for buffers and other intermediate process fluids. These devices provide broad chemical compatibility, high flow rates and extended throughput for superior process efficiency and economy.

Developed to Enhance Buffer and Process Intermediate Filtration

Millipore Express® PHF filters use a fast flowing membrane specifically developed for the filtration of buffers, pH adjusters and other aqueous intermediate pharmaceutical and biotech solutions. Designed to offer high-flux performance and improved process economics, Millipore Express® PHF filters are compatible with a wide range of process chemistries, including acids and sodium hydroxide.



Filter Applications

- Buffer solutions
- Process additives and intermediates

Benefits

- Sterilizing-grade
- Faster flow rates than most sterilizing-grade filters, reducing process footprint
- Multiple steam-in-place or autoclave sterilization cycles
- Single-use, gamma ready formats
- Broad chemical compatibility, high and low pH (1–14)
- Fully scalable product offering

Specifications

OptiScale® Capsules and Opticap® XL 150, 300 and 600 Disposable Capsules (Sterile and Gamma Compatible)

	OptiScale® 25 Capsules	Opticap® XL 150 Capsules	Opticap® XL 300 Capsules	Opticap® XL 600 Capsules
Nominal Dimensions				
Maximum length:	39 mm (1.5 in.)	9.7 cm (3.8 in.)	11.9 cm (4.7 in.)	16.5 cm (6.5 in.)
Body diameter:	31 mm (1.2 in.)	5.6 cm (2.2 in.)		
Filtration Area	3.5 cm ²	0.022 m ² (0.240 ft ²)	0.048 m ² (0.514 ft ²)	0.097 m ² (1.046 ft ²)
Materials of Construction				
Filter membrane:	Hydrophilic polyethersulfone	Hydrophilic polyethersulfone		
Supports:	Polypropylene	Polyethylene		
Structural components*:	Polypropylene	Gamma stable polypropylene		
Core:	-	Polysulfone		
Vent O-rings:	-	Silicone		
Vent/Drain	Capped vent with female Luer connections on inlet side of device	6 mm (¼ in.) hose barb with double O-ring seal		
Maximum Inlet Pressure	4100 mbar (60 psi) at 25 °C	5500 mbar (80 psi) at 25 °C		
Maximum Differential Pressure				
Forward:	4100 mbar (60 psi) at 25 °C	5500 mbar (80 psi) at 25 °C		
Reverse:	-	1400 mbar (20 psi) at 25 °C		
Air Diffusion at 23 °C	-	Through a water wet membrane at 2700 mbar (40 psi):		
		≤ 1.4 cc/min.	≤ 2.8 cc/min.	≤ 5.8 cc/min.
Bacterial Endotoxin	Aqueous extraction contains < 0.25 EU/mL as determined by the Limulus Amebocyte Lysate (LAL) Test			
Bacterial Retention	-	Quantitative retention of 10 ⁷ CFU/cm ² <i>Brevundimonas diminuta</i> ATCC® 19146 per ASTM® methodology		
TOC/Conductivity at 25 °C	Filter effluent meets the WFI requirements of USP <643> for Total Organic Carbon and USP <645> for Water Conductivity after a WFI flush of 15 mL at 25 °C	Gamma Sterilized filter effluent meets the WFI requirements of USP <643> for Total Organic Carbon and USP <645> for Water Conductivity at 25 °C and after a WFI flush of:		
		2.0 L	2.5 L	3.0 L
Sterilization				
Gamma-compatible capsules:	May be autoclaved for 1 cycle at 123 °C for 60 min.	Gamma compatible to 40 kGy may be autoclaved for 3 cycles of 60 minutes at 123 °C (Cannot be steam sterilized in-line)		
Sterile capsules:	-	May be autoclaved for 3 cycles of 60 minutes at 123 °C (Cannot be steam sterilized in-line)		
Sterility				
Sterile capsules:	-	These capsules meet current USP and AAMI guidelines for sterility utilizing a validated sterilization cycle.		
Toxicity	-	Non-toxic per MEM Elution ISO 10993-05		
Particle Shedding	Effluent meets the acceptance criteria set forth in USP <788> for large volume parenterals.			
Non-Fiber Releasing	Component materials meet criteria for a "non-fiber releasing" filter as defined in 21 CFR 210.3 (b) (6).			
Component Material Toxicity	Component materials were tested and meet the criteria of the USP <88> Reactivity Test for Class VI plastics.			
Indirect Food Additive	All component materials meet the FDA Indirect Food Additive requirements cited in 21 CFR 177-182.			
Good Manufacturing Practices	These products are manufactured in a facility which adheres to FDA Good Manufacturing Practices.			

* Cage, end caps and capsule housing

Filters were tested post gamma radiation at 25-40 kGy.

Typical Clean Water Flow Rates

Opticap® XL and XLT Disposable Capsules (Sterile and Gamma Compatible)

Filters were tested post gamma radiation at 25 - 40 kGy and autoclaved at 123 °C for 60 minutes.

Opticap® XL 150 Capsule Filters with 0.2 µm Millipore Express® PHF Membrane

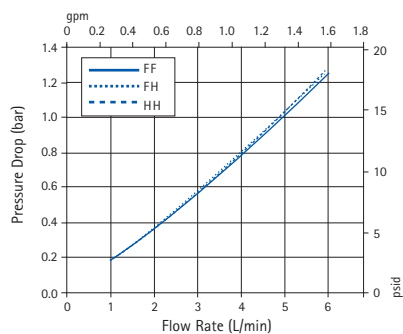

Opticap® XL 300 Capsule Filters with 0.2 µm Millipore Express® PHF Membrane

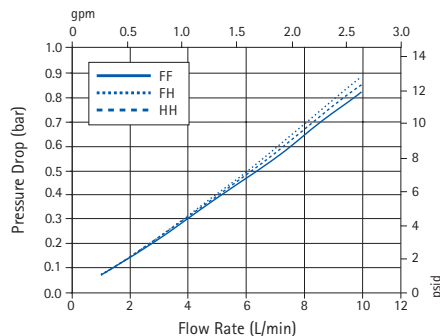

Opticap® XL 600 Capsule Filters with 0.2 µm Millipore Express® PHF Membrane

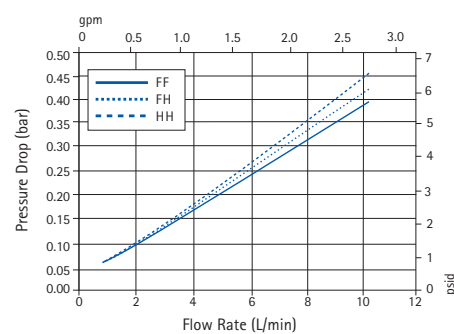

Opticap® XL 150, 300 & 600 Capsule Legends Refer to Connection Type

FF = 19 mm (³/₄ in.) sanitary flange inlet and outlet

FH = 19 mm (³/₄ in.) sanitary flange inlet and
14 mm (⁹/₁₆ in.) hose barb outlet

HH = 14 mm (⁹/₁₆ in.) hose barb inlet and outlet

Specifications

Opticap® XL and XLT Disposable Capsules (Autoclavable)

	Opticap® XL 3 Capsules	Opticap® XL 5 Capsules	Opticap® XL 10 Capsules	Opticap® XLT 10 Capsules	Opticap® XLT 20 Capsules	Opticap® XLT 30 Capsules
Nominal Dimensions						
Maximum length:	17.3 cm (6.8 in.)	21.6 cm (8.5 in.)	33.5 cm (13.2 in.)	37.6 cm (14.8 in.)	62.5 cm (24.6 in.)	87.1 cm (34.3 in.)
Fitting to Fitting						
Sanitary flange to sanitary flange:	-	-	-	15.2 cm (6.0 in.)		
Sanitary flange to hose barb:	-	-	-	17.5 cm (6.9 in.)		
Hose barb to hose barb:	-	-	-	19.8 cm (7.8 in.)		
Filtration Area	0.16 m ² (1.7 ft ²)	0.29 m ² (3.1 ft ²)	0.54 m ² (5.8 ft ²)	0.54 m ² (5.8 ft ²)	1.08 m ² (11.6 ft ²)	1.62 m ² (17.4 ft ²)
Materials of Construction						
Filter membrane:	Hydrophilic polyethersulfone					
Film edge:	Polypropylene					
Supports:	Polypropylene					
Structural components*:	Polypropylene					
Core:	Polysulfone					
Vent O-rings:	Silicone					
Vent/Drain	6 mm (¼ in.) hose barb with double O-ring seal					
Maximum Inlet Pressure	5500 mbar (80 psi) at 25 °C					
Maximum Differential Pressure						
Forward:	5500 mbar (80 psi) at 25 °C					
Air Diffusion at 23 °C	Through a water wet membrane at 2800 mbar (40 psi):					
	≤ 9.1 cc/min.	≤ 16.4 cc/min.	≤ 30 cc/min.	≤ 30 cc/min.	≤ 60 cc/min.	≤ 90 cc/min.
Bacterial Retention	Quantitative retention of 10 ⁷ CFU/cm ² <i>Brevundimonas diminuta</i> ATCC® 19146 per ASTM® methodology					
Bacterial Endotoxin	Aqueous extraction contains <0.25 EU/mL as determined by the Limulus Amebocyte Lysate (LAL) Test (per 10-inch filter).					
TOC/Conductivity	Autoclaved capsule effluent meets the WFI criteria for USP <643>, Total Organic Carbon and USP <645>, Conductivity at 25 °C and after a WFI flush of:					
	3.0 L	5.5 L	10 L	10 L	20 L	30 L
Sterilization	May be autoclaved for 3 cycles of 60 minutes at 126 °C (cannot be steam sterilized in-line)					
Non-Fiber Releasing	Component materials meet criteria for a "non-fiber releasing" filter as defined in 21 CFR 210.3 (b) (6).					
Component Material Toxicity	Component materials were tested and meet the criteria of the USP <88> Reactivity Test for Class VI plastics.					
Toxicity	Non-toxic per MEM Elution ISO 10993-05					
Good Manufacturing Practices	These products are manufactured in a facility which adheres to FDA Good Manufacturing Practices.					
Indirect Food Additive	All component materials meet the FDA Indirect Food Additive requirements cited in 21 CFR 177-182.					

* Cage, end caps and capsule housing

Typical Clean Water Flow Rates

Opticap® XL and XLT Disposable Capsules (Autoclavable)

Opticap® XL 3 Capsule Filters with 0.2 µm Millipore Express® PHF Membrane

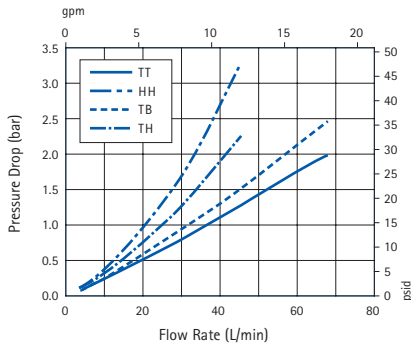

Opticap® XL 5 Capsule Filters with 0.2 µm Millipore Express® PHF Membrane

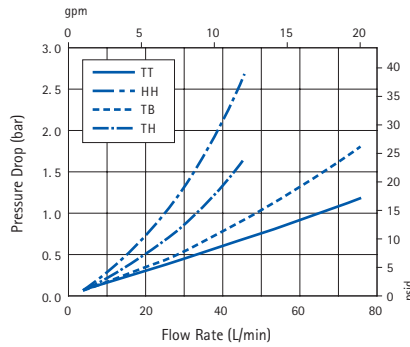

Opticap® XL 10 Capsule Filters with 0.2 µm Millipore Express® PHF Membrane

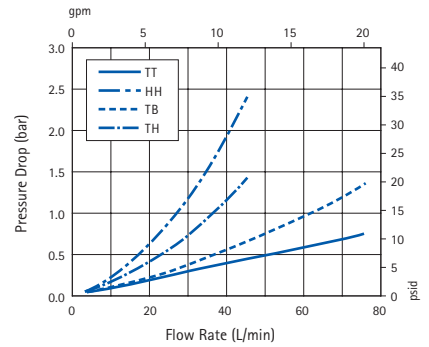

Opticap® XLT 10 Capsule Filters with 0.2 µm Millipore Express® PHF Membrane

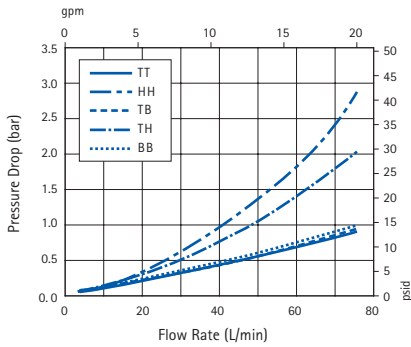

Opticap® XLT 20 Capsule Filters with 0.2 µm Millipore Express® PHF Membrane

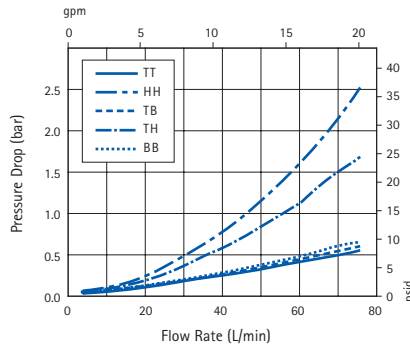

Opticap® XLT 30 Capsule Filters with 0.2 µm Millipore Express® PHF Membrane

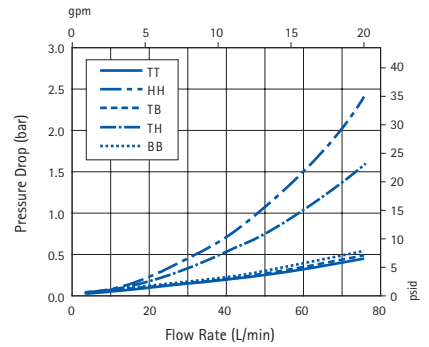

Opticap® XL Capsule Legends Refer to Connection Type

- TT = 38 mm (1 in.) Sanitary Flange Inlet and Outlet
- HH = 14 mm (9/16 in.) Hose Barb Inlet and Outlet
- TH = 38 mm (1 1/2 in.) Sanitary Flange Inlet and 14 mm (9/16 in.) Hose Barb Outlet
- TB = 38 mm (1 1/2 in.) Sanitary Flange Inlet and 25 mm (1 in.) Hose Barb Outlet

Opticap® XLT Capsule Legends Refer to Connection Type

- TT = 38 mm (1 1/2 in.) Sanitary Flange Inlet and Outlet
- TH = 38 mm (1 1/2 in.) Sanitary Flange Inlet and 16 mm (5/8 in.) Hose Barb Outlet
- HH = 16 mm (5/8 in.) Hose Barb Inlet and Outlet
- BB = 25 mm (1 in.) Hose Barb Inlet and Outlet
- TB = 38 mm (1 1/2 in.) Sanitary Flange Inlet and 25 mm (1 in.) Hose Barb Outlet

Specifications

Opticap® XL and XLT Disposable Capsules (Sterile and Gamma Compatible)

	Opticap® XL 3 Capsules	Opticap® XL 5 Capsules	Opticap® XL 10 Capsules	Opticap® XLT 10 Capsules	Opticap® XLT 20 Capsules	Opticap® XLT 30 Capsules
Nominal Dimensions						
Maximum length:	17.3 cm (6.8 in.)	21.6 cm (8.5 in.)	33.5 cm (13.2 in.)	37.6 cm (14.8 in.)	62.5 cm (24.6 in.)	87.1 cm (34.3 in.)
Body diameter:	10.7 cm (4.2 in.)			-		
Fitting to Fitting						
Sanitary flange to sanitary flange:	-	-	-	15.2 cm (6.0 in.)		
Sanitary flange to hose barb:	-	-	-	17.5 cm (6.9 in.)		
Hose barb to hose barb:	-	-	-	19.8 cm (7.8 in.)		
Filtration Area	0.17 m ² (1.8 ft ²)	0.31 m ² (3.3 ft ²)	0.57 m ² (6.1 ft ²)	0.57 m ² (6.1 ft ²)	1.14 m ² (12.3 ft ²)	1.71 m ² (18.4 ft ²)
Materials of Construction						
Filter membrane:	Hydrophilic polyethersulfone					
Film edge:	Polyethylene					
Supports:	Polyester					
Structural components*:	Gamma stable polypropylene					
Core:	Polysulfone					
Vent O-rings:	Silicone					
Vent/Drain	6 mm (¼ in.) hose barb with double O-ring seal					
Maximum Inlet Pressure	5500 mbar (80 psi) at 25 °C					
Maximum Differential Pressure						
Forward:	5500 mbar (80 psi) at 25 °C					
Air Diffusion at 23 °C	Through a water wet membrane at 2800 mbar (40 psi):					
	≤ 9.5 cc/min.	≤ 17.4 cc/min.	≤ 32.7 cc/min.	≤ 32.7 cc/min.	≤ 65.5 cc/min.	≤ 98.2 cc/min.
Bacterial Retention	Quantitative retention of 10 ⁷ CFU/cm ² <i>Brevundimonas diminuta</i> ATCC® 19146 per ASTM® methodology					
Bacterial Endotoxin	Aqueous extraction contains <0.25 EU/mL as determined by the Limulus Amebocyte Lysate (LAL) Test (per 10-inch filter).					
TOC/Conductivity	Gamma sterilized capsule effluent meets the WFI criteria for USP <643>, Total Organic Carbon, and USP <645>, Conductivity, at 25 °C and after a WFI flush of:					
	3.5 L	6.0 L	11 L	11 L	22 L	33 L
Sterilization						
Gamma-compatible capsules:	Gamma compatible to 40 kGy May be autoclaved for 3 cycles of 60 minutes at 123 °C (cannot be steam sterilized in-line)					
Sterile capsules:	May be autoclaved for 3 cycles of 60 minutes at 123 °C (cannot be steam sterilized in-line)					
Sterility						
Sterile capsules:	These capsules meet current USP and AAMI guidelines for sterility utilizing a validated sterilization cycle.					
Non-Fiber Releasing	Component materials meet criteria for a "non-fiber releasing" filter as defined in 21 CFR 210.3 (b) (6).					
Component Material Toxicity	Component materials were tested and meet the criteria of the USP <88> Reactivity Test for Class VI plastics.					
Toxicity	Non-toxic per MEM Elution ISO 10993-05					
Good Manufacturing Practices	These products are manufactured in a facility which adheres to FDA Good Manufacturing Practices.					
Indirect Food Additive	All component materials meet the FDA Indirect Food Additive requirements cited in 21 CFR 177-182.					

* Cage, end caps and capsule housing

Filters were tested post gamma radiation at 25-40 kGy.

Typical Clean Water Flow Rates

Opticap® XL and XLT Disposable Capsules (Sterile and Gamma Compatible)

Filters were tested post gamma radiation at 25-40 kGy.

Opticap® XL 3 Capsule Filters with 0.2 µm Millipore Express® PHF Membrane

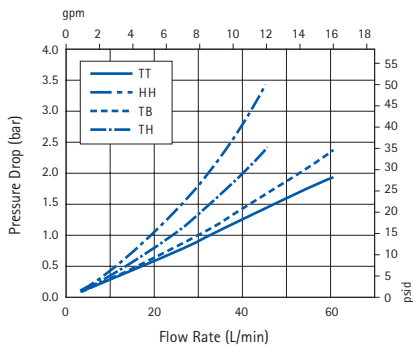

Opticap® XL 5 Capsule Filters with 0.2 µm Millipore Express® PHF Membrane

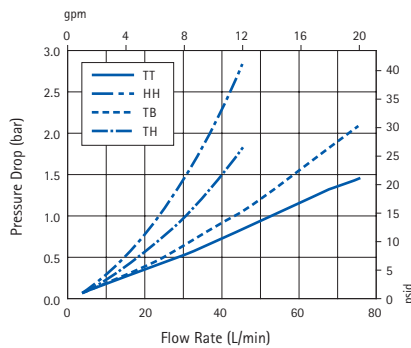

Opticap® XL 10 Capsule Filters with 0.2 µm Millipore Express® PHF Membrane

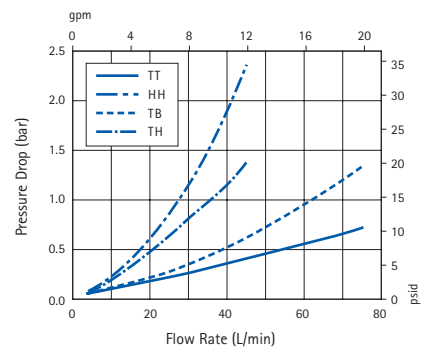

Opticap® XLT 10 Capsule Filters with 0.2 µm Millipore Express® PHF Membrane

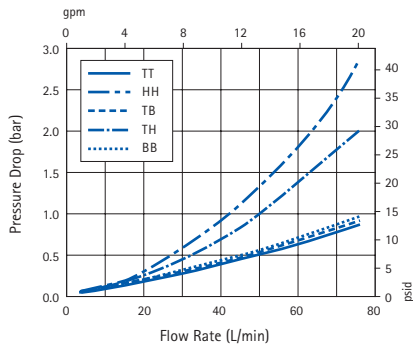

Opticap® XLT 20 Capsule Filters with 0.2 µm Millipore Express® PHF Membrane

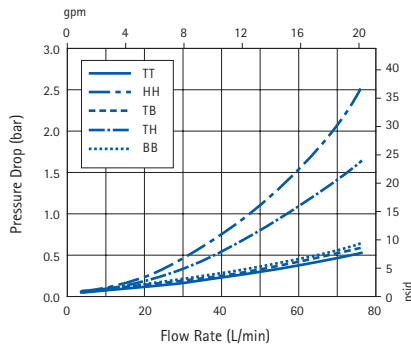

Opticap® XLT 30 Capsule Filters with 0.2 µm Millipore Express® PHF Membrane

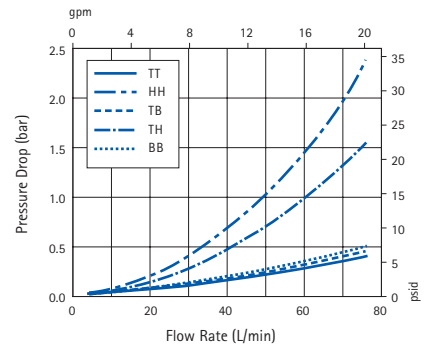

Opticap® XL Capsule Legends Refer to Connection Type

- TT = 38 mm (1 in.) Sanitary Flange Inlet and Outlet
- HH = 14 mm (9/16 in.) Hose Barb Inlet and Outlet
- TH = 38 mm (1 1/2 in.) Sanitary Flange Inlet and 14 mm (9/16 in.) Hose Barb Outlet
- TB = 38 mm (1 1/2 in.) Sanitary Flange Inlet and 25 mm (1 in.) Hose Barb Outlet

Opticap® XLT Capsule Legends Refer to Connection Type

- TT = 38 mm (1 1/2 in.) Sanitary Flange Inlet and Outlet
- TH = 38 mm (1 1/2 in.) Sanitary Flange Inlet and 16 mm (5/8 in.) Hose Barb Outlet
- HH = 16 mm (5/8 in.) Hose Barb Inlet and Outlet
- BB = 25 mm (1 in.) Hose Barb Inlet and Outlet
- TB = 38 mm (1 1/2 in.) Sanitary Flange Inlet and 25 mm (1 in.) Hose Barb Outlet

Specifications Cartridge Filters

	5-inch Cartridges	Per 10-inch Cartridge
Nominal Dimensions		
Diameter:	6.9 cm (2.7 in.)	6.9 cm (2.7 in.)
Length:	12.5 cm (5 in.)	25.4 cm (10 in.)
Filtration Area	0.29 m ² (3.1 ft ²)	0.54 m ² (5.8 ft ²)
Materials of Construction	Hydrophilic polyethersulfone	
Filter membrane:	Polypropylene	
Film edge:	Polypropylene	
Supports:	Polypropylene	
Cage and end caps:	Polypropylene	
Core:	Polysulfone	
O-rings:	Silicone, EPDM or Fluoroelastomer	
Maximum Differential Pressure		
Forward:	5500 mbar (80 psi) at 25 °C 1700 mbar (25 psi) at 80 °C 300 mbar (5 psi) at 135 °C	
Reverse:	1400 mbar (20 psi) at 25 °C 69 mbar (1 psi) at 135 °C	
Air Diffusion at 23 °C	Through a water wet membrane at 2800 mbar (40 psi): ≤ 16.4 cc/min. ≤ 30.0 cc/min.	
Bacterial Retention	Quantitative retention of 10 ⁷ CFU/cm ² <i>Brevundimonas diminuta</i> ATCC® 19146 per ASTM® methodology	
Bacterial Endotoxin	Aqueous extraction contains <0.25 EU/mL as determined using the Limulus Amebocyte Lysate (LAL) test.	
TOC/Conductivity	Autoclaved cartridge effluent meets the WFI criteria for USP <643>, Total Organic Carbon, and USP <645>, Conductivity, after a WFI flush of: 5.5 L at 25 °C 10 L at 25 °C	
Sterilization	Autoclave: May be autoclaved for 15 cycles of 60 minutes at 126 °C In-line Steam: May be in-line steamed forward for 15 cycles of 30 minutes at 135 °C or forward for 12 cycles and reverse for 3 cycles of 30 minutes at 135 °C	
Toxicity	Component materials meet the criteria for the USP Class VI Biological Test for Plastics.	
Non-fiber Releasing	Component materials meet criteria for a "non-fiber releasing" filter as defined in 21 CFR 210.3 (b) (6).	
Component Material Toxicity	Component materials were tested and meet the criteria of the USP <88> Reactivity Test for Class VI plastics.	
Indirect Food Additive	All component materials meet the FDA Indirect Food Additive requirements cited in 21 CFR 177–182.	
Good Manufacturing Practices	These products are manufactured in a facility which adheres to FDA Good Manufacturing Practices.	

Typical Clean Water Flow Rates Cartridge Filters with 0.2 µm Millipore Express® PHF Hydrophilic Membrane

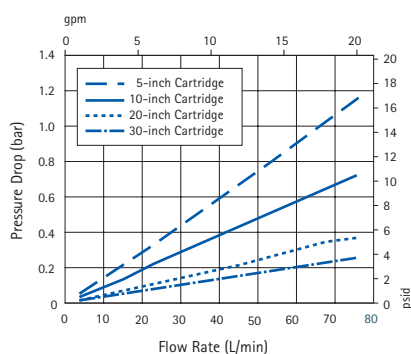

User Guide, Wetting Instructions, Integrity Testing and Drying guidelines document for this product family is available online at the Millipore Express® PHF product page.

Ordering Information

OptiScale® 25 Capsule Filters

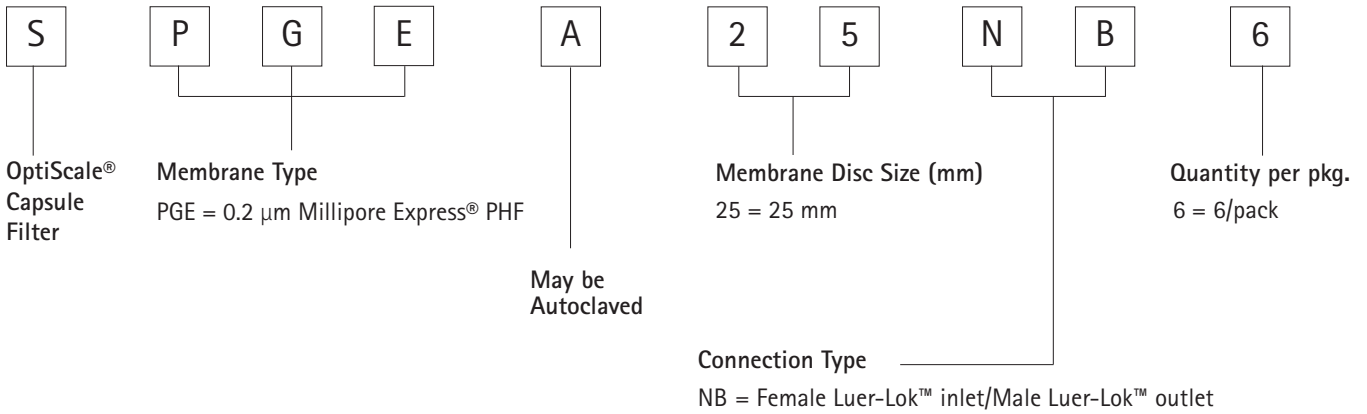

Opticap® XL 150/300/600 Capsule Filters

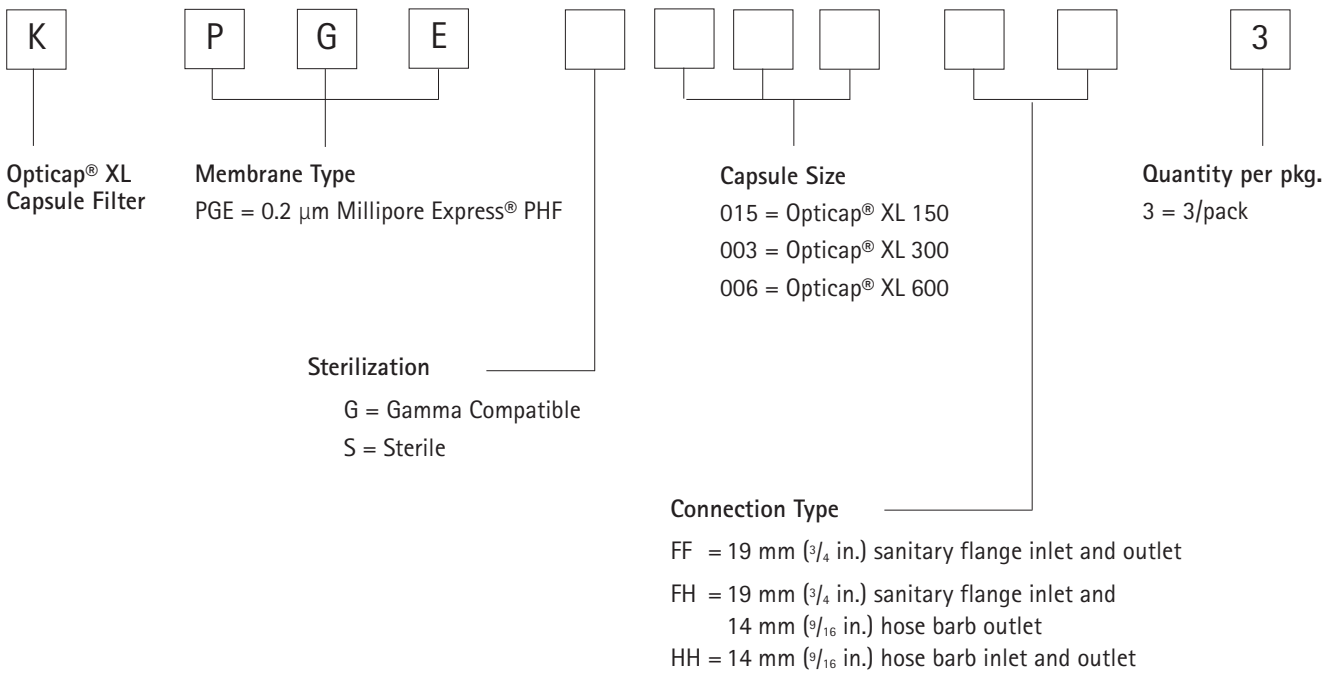

Ordering Information

Opticap® XL Capsule Filters

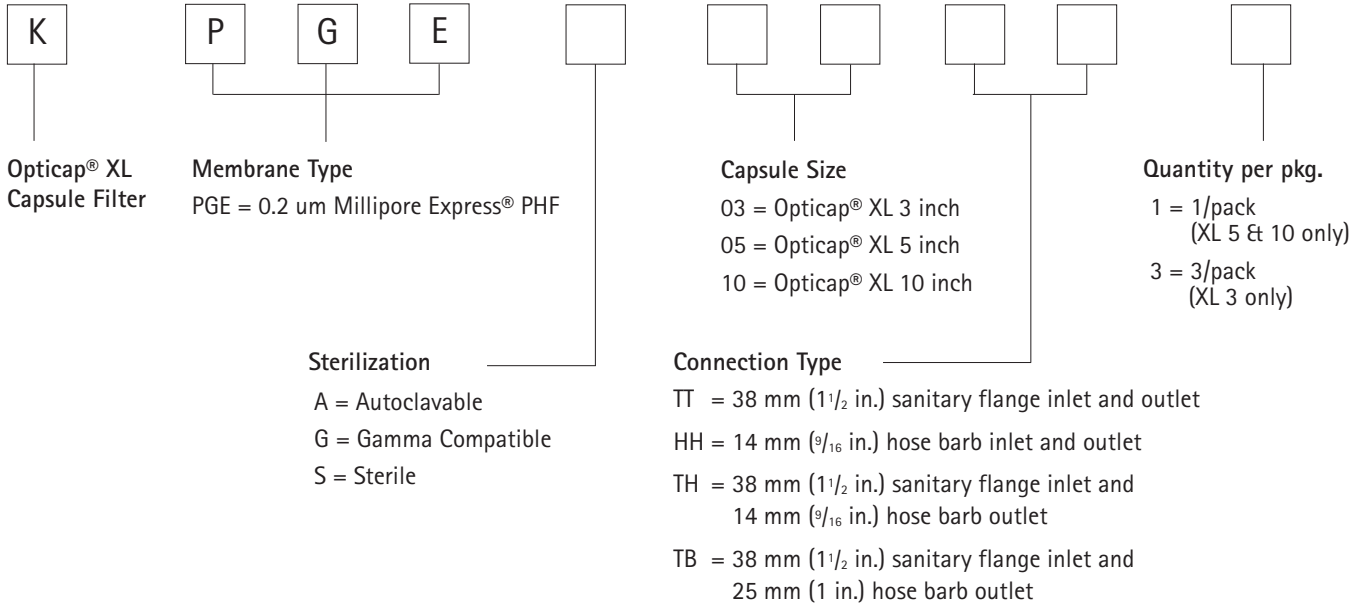

Opticap® XLT Capsule Filters

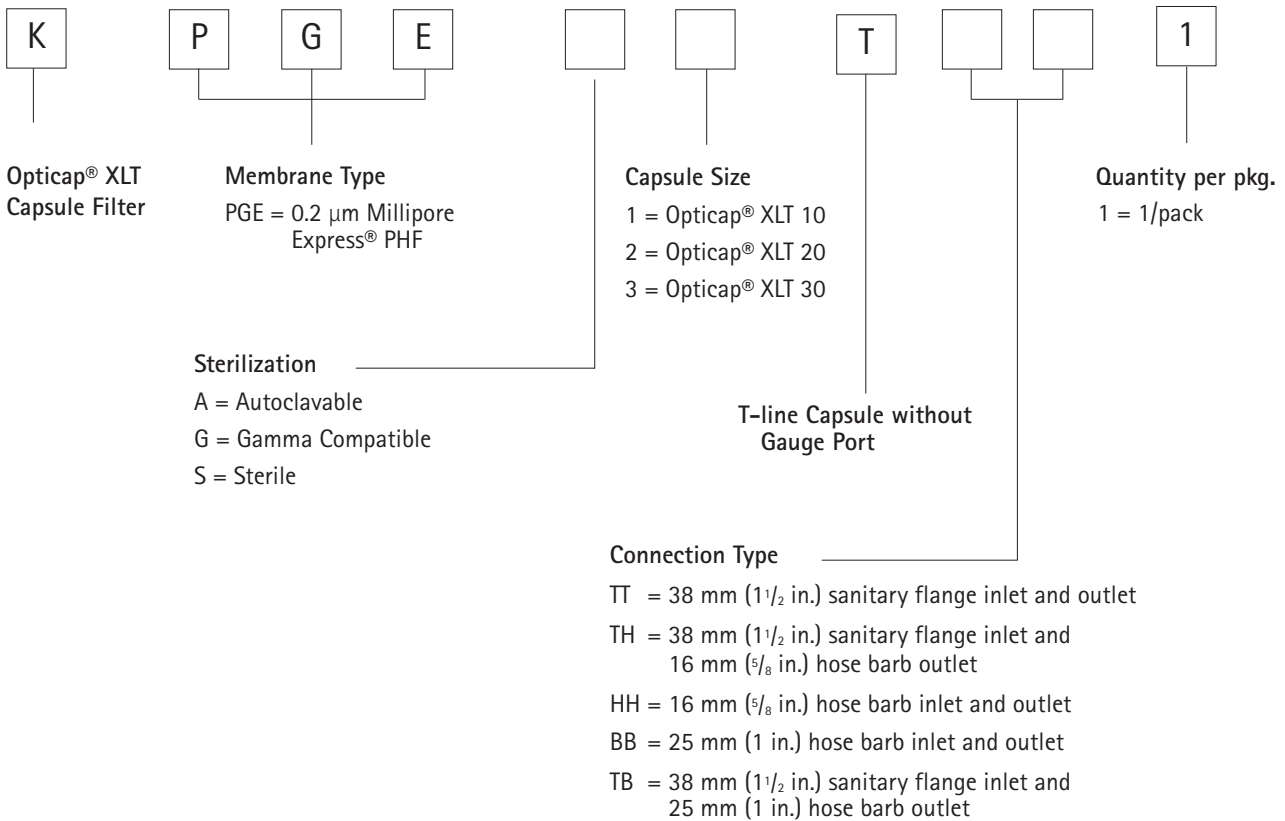

Ordering Information

Cartridge Filters

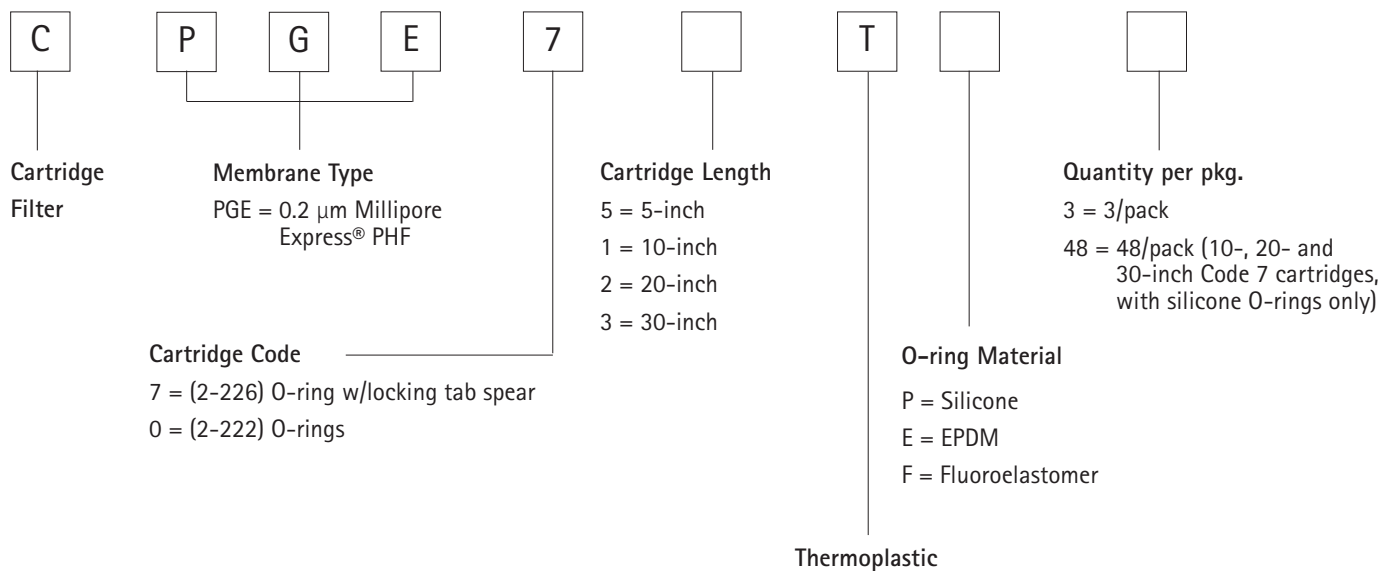

* Products shown not guaranteed available; please contact your EMD Millipore representative to confirm availability.



To place an order or receive technical assistance

In the U.S. and Canada,
call toll-free 1-800-645-5476

For other countries across Europe and the world,
please visit: www.emdmillipore.com/offices

For Technical Service, please visit:
www.emdmillipore.com/techservice



www.emdmillipore.com/offices