

**Minimize
Complexity.
Magnify
Your Focus.**

Milli-Q® IQ 7003/05/10/15

Integrated Ultrapure & Pure Water Systems

Designed to exceed your most
demanding expectations.

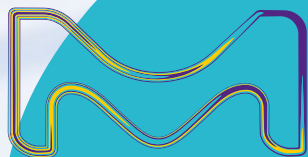

The life science business of Merck
KGaA Darmstadt Germany operates as
MilliporeSigma in the U.S. and Canada.

Milli-Q®
Lab Water Solutions

Meet the Ultimate Lab Water Solution

Surpassing all expectations — NEW Milli-Q® IQ 7003/7005/7010/7015 ultrapure and pure water system

The new Milli-Q® tap-to-ultrapure system series is a fully-integrated lab water solution designed to exceed your most demanding expectations — from improved productivity and versatility, to reduced environmental impact.

Beyond delivering **superior quality Type 1 and Type 2 water** directly from a tap water source, the system takes the security of your water quality to the next level of care with a newly integrated **intelligent pure water storage solution** that protects your water’s purity better than ever before (*learn more on page 5*).

With the Milli-Q® IQ 7003/05/10/15 system, **exceptional quality water is always on hand** where and when you need it. The system connects to our ergonomic and easy-to-use **Q-POD® ultrapure** and **new E-POD® pure water dispensers**. Up to 4 PODs can be supplied by a single purification unit, giving you convenient access to purified water, even on distant benches. (*See opposite page*).



Enjoy our newly redesigned E-POD® dispenser for convenient, rapid access to pressurized pure water, and similar design features as our popular Q-POD® ultrapure water dispenser.

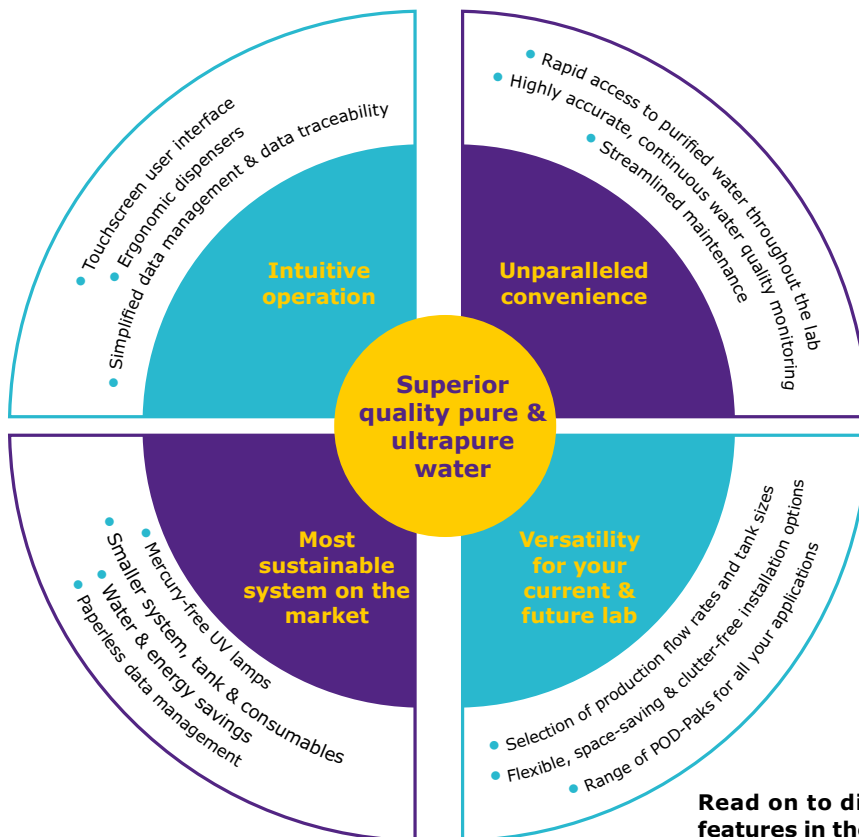

Read on to discover all the intelligent design features in the new Milli-Q® IQ 7003/05/10/15 system!

Minimize effort. Magnify daily efficiency.

E-POD® and Q-POD® dispensers are compact, ergonomic and intuitive, making lab work more effortless and enjoyable than ever.

Always have rapid and convenient access to ultrapure and pure water. A single Milli-Q® IQ 7003/05/10/15 system can support up to 4 easy-to-use POD dispensers. Essential system functions remain close at hand on each POD's touchscreen. The compact purification unit and tank can be tucked away, on the wall or under the bench, leaving benchtops free of clutter for an optimized lab space and more efficient working environment.



Made-to-measure dispensing

Choose the speed you need – from drop-by-drop to up to 2 L/min

Precision filling – avoid intermediary containers with Assisted Dispense mode on the Q-POD® unit for a drop-by-drop finish

Walk-away filling – program your final volume and continue working with Volumetric Dispense mode

Twist, tap, or use no hands at all – twist the dispense wheel, tap the touchscreen menu to set the volume or speed, or try the foot pedal option for hands-free filling

Monitor continuously – key quality parameters are always visible onscreen during dispensing, for full confidence in your water quality

Tailor final quality – choose from our wide range of application POD-Paks for water quality adapted to your specific needs

Made-to-measure control

Interact effortlessly – smartphone-like touchscreens allow intuitive use, even with gloves on!

Personalize views – program the interface that suits your lab's specific needs

Customize reports – easily create individual Dispense reports, determine average water quality over a specific time range, or even allocate costs for shared resources

Rapidly retrieve data – view data directly onscreen or export it via a convenient USB port located on each POD. You can even scan a report's QR code to easily send yourself the pdf

Goodbye user manual – onscreen, graphic instructions guide you through consumable changes and help manage alerts and alarms

Minimize stagnation. Magnify protection.

Experience the confidence of knowing that water quality is not impacting your experiments. Superior quality ultrapure and pure water are achieved directly from a tap water source.

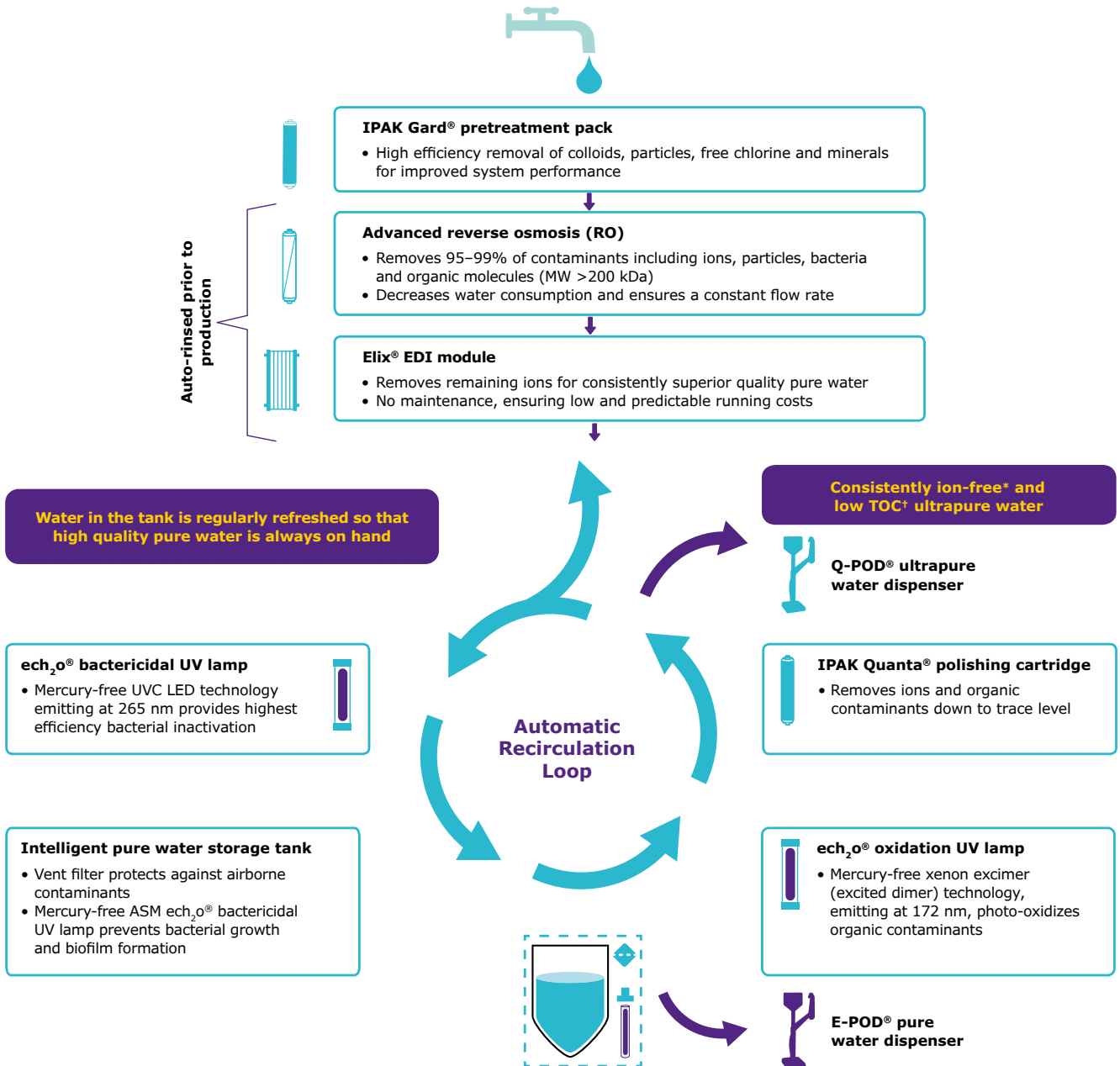

*18.2 MΩ.cm at 25 °C.

†In the appropriate operating conditions ≤2 ppb; otherwise typically ≤5 ppb.

ASM, automatic sanitization module; EDI, electrodeionization; TOC, total organic carbon.

Our best-ever protection of stored pure water.

Introducing an intelligent storage solution that is uniquely designed to safeguard your water's purity better than ever before.



25 L



50 L



100 L

Three tank sizes are available to ensure your lab's needs can be met today and tomorrow.

- **Prior to water production**, automatic rinsing of the RO membrane and the Elix® EDI module ensures that only the highest quality pure water enters the tank
- **Within the tank**, pure water quality is preserved by two built-in features:
 - **Vent filter**, redesigned for seamless integration, provides improved protection against airborne contaminants
 - **Automatic Sanitization Module (ASM)** with an integrated mercury-free ech₂o® UVC LED lamp emitting at 265 nm, regularly irradiates stored water and tank walls, preventing bacterial growth and biofilm formation
- **Automatic recirculation of stored water** through a bactericidal UV lamp preserves water quality in the tank and ensures that high-quality Type 2 water is always on hand and ready to use

Minimize contaminants. Magnify confidence.

Avoid uncertainty, misinterpreting results, or repeating time-consuming and costly analyses. The Milli-Q® IQ 7003/05/10/15 system always delivers superior quality Type 1 and Type 2 water.

The new Milli-Q® integrated ultrapure and pure water systems contain purification media, hydraulic design and software capabilities that are designed and tested exclusively for MilliporeSigma. It is also the first and only completely mercury-free tap-to-ultrapure water system on the market, containing our patented $\text{ech}_2\text{o}^\circledR$ UV lamps. With our advanced and sustainable technologies, you always achieve the best water quality, backed by over 50 years of experience in the industry.

Superior quality water also means best system performance and longer cartridge lifetimes.

Some of the new and innovative technologies found in the Milli-Q® IQ 7003/05/10/15 system:

- Patented mercury-free $\text{ech}_2\text{o}^\circledR$ UV lamps
- A redesigned and more intelligent pure water solution
- High-efficiency IPAK Gard® and IPAK Quanta® purification cartridges
- Seamlessly integrated tank vent filter

Powerful & patented purification media



Pleated filter

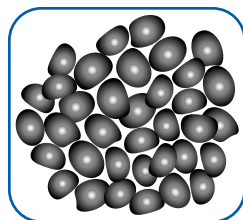

Carbon block



IPAK Gard



IPAK Quanta



Activated carbon

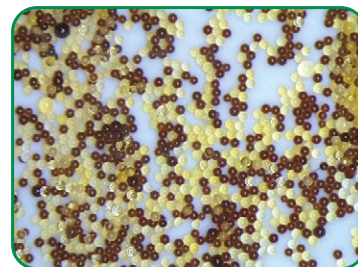

IQnano

New IPAK Gard® pretreatment pack

- Pleated filter and carbon block components provide high-efficiency removal of colloids, particles and free chlorine from tap water
- Pack type can be tailored with polyphosphate beads for added protection against scaling of the RO membrane

IPAK Quanta® polishing cartridge

- Innovative IQnano® ion-exchange media achieves ion removal down to trace levels; small bead size significantly improves kinetic properties while dramatically reducing media volume — 33% less than former Milli-Q® purification cartridges
- High-grade synthetic activated carbon targets traces of organic contaminants

Advanced reverse osmosis (RO) reduces water consumption and associated costs

- Removes 95–99% of ions, and 99% of all dissolved large organics, microorganisms and particles
- RO recovery loop optimizes water recovery vs. standard RO systems and reduces water consumption by up to 50%
- Produces a constant product flow rate, regardless of feed water temperature or conductivity, enabling the system to adapt to a wide range of feed water types
- Only high-quality water enters the Elix® EDI module

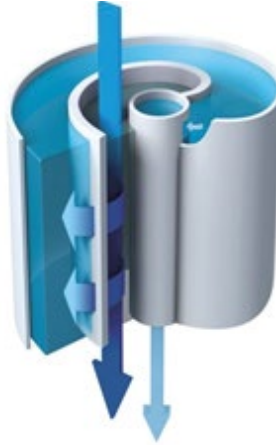

Flow-through view of an Advanced RO membrane, which is inserted into a cartridge. Tangential flow limits the risk of fouling.

Elix® electrodeionization (EDI) module produces constant-quality pure water with no maintenance and at low and predictable running costs

- Our patented Elix® EDI module removes remaining ions to produce constant-quality pure water, regardless of feed water quality (conductivity, CO₂ levels) or RO cartridge performance
- Module continuously self-regenerates its ion-exchange resins via a small electrical field
- Eliminates the need for:
 - Hazardous chemical regeneration procedures
 - Replacement of costly resins
 - Changing DI cartridges
 - Adding softeners
- Reduces maintenance time and ensures low and predictable running costs

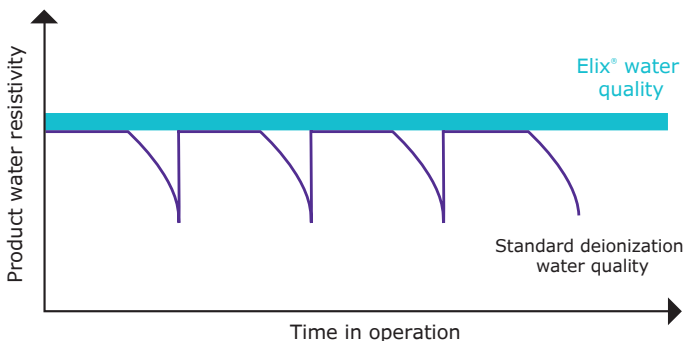
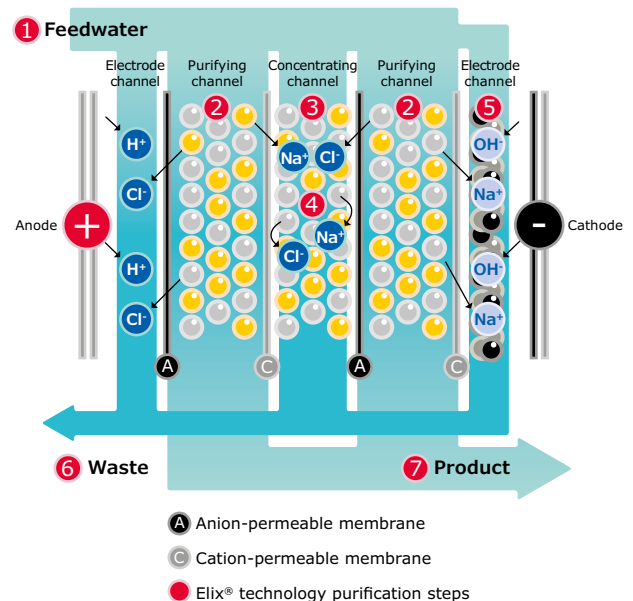

The graph shows the superiority of Elix® technology over systems using ion-exchange resin packs. Resistivity drops dramatically when packs are exhausted.

Elix® module

Our unique technology is based on anion- and cation-permeable membranes, high-quality ion-exchange resin and activated carbon beads, placed in an electric field. Water produced by the Elix® module enters the tank with resistivity greater than 5 MΩ·cm at 25 °C (typically up to 15 MΩ·cm at 25 °C).* Ion exchange resins are constantly regenerated by the electric field, without any chemicals needed.

*When CO₂ dissolved in feed water is less than 30 ppm.

Minimize uncertainty. Magnify reliability.

Q: What's better than ion-free water?

Ultrapure water from the Milli-Q® IQ 7003/05/10/15 system ensures that your experiments are safe from trace ionic contaminants. Ion chromatography (IC) validation data show that the system is able to consistently and reliably produce ion-free water at the sub-ppb level. Resistivity is continuously monitored on the POD touchscreen by our precise in-line resistivity cell, with a 0.01 cm⁻¹ low cell constant and a 0.1 °C sensitive thermistor.

Milli-Q® IQ 7003 IC cation chromatogram

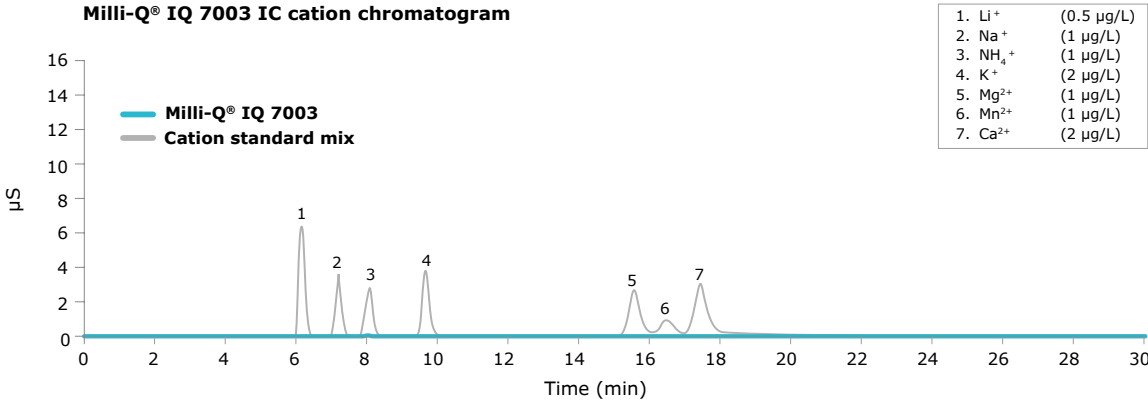

Milli-Q® IQ 7003 IC anion chromatogram

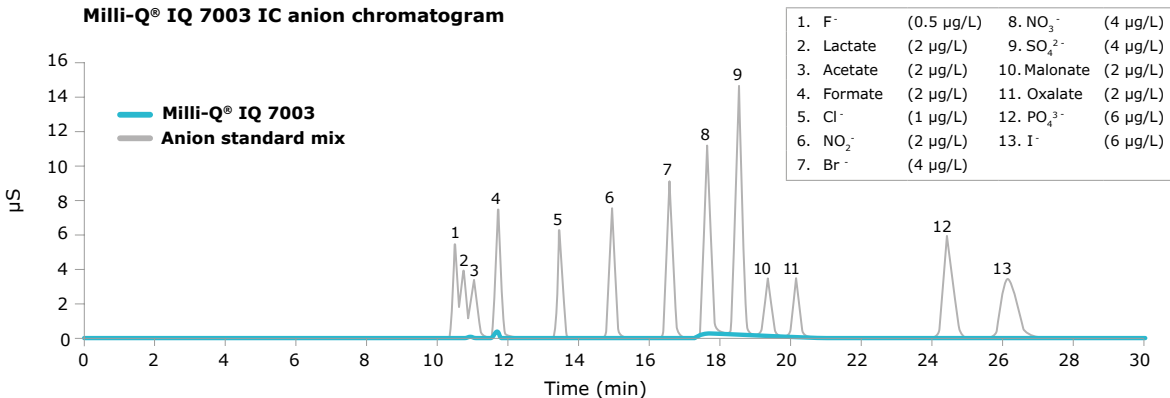

A: Low TOC and mercury free.

The Milli-Q® IQ 7003/05/10/15 system delivers consistently low TOC (Total Organic Carbon) ultrapure water thanks to our optimized sequence of state-of-the-art purification technologies.

Rapid and highly accurate TOC measurements are achieved with our best-in-class online A10® monitor, which has been redesigned versus the prior Milli-Q® Integral system for even greater accuracy.

A10® TOC monitor benefits

- ech₂o® mercury-free lamp
- High accuracy enabled by complete oxidation of organics to their end-point reaction, thanks to oxidation and conductivity measurements occurring within the same cell
- Range (0.5–999.9) and precision passing USP and EP suitability tests

TOC measuring process within the A10® quartz cell

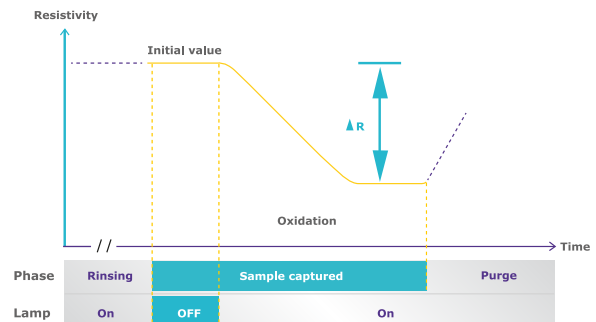

Water quality matched to your every application.

Our POD-Paks provide the perfect solution to meet the needs of your various applications. Each Application-Pak polisher targets specific contaminants and removes them right at the POD dispenser.

If you need several types of ultrapure and pure water, simply connect different POD-Paks to your different dispensing units. Up to 4 POD dispensers (1 E-POD® + 3 Q-POD® units, or 4 Q-POD® units) may be connected to a single system.

Millipak® & sterile Millipak® Gold: 0.22 µm filters for bacteria-free and particulate-free water

EDS-Pak®: water for endocrine disruptor-related applications

Biopak®: pyrogen-, nuclease-, protease- and bacteria-free water



LC-Pak®: water for ultra-trace organic sensitive applications

VOC-Pak®: water for volatile organic compound-related analyses

With the appropriate Application-Pak installed, your Milli-Q® IQ 7003/05/10/15 system will provide water suitable for most of the analytical techniques used in the laboratory, including:

- HPLC
- LC-MS
- UHPLC
- MALDI-ToF-MS
- AAS
- ICP-MS
- CE
- IC
- Particle analysis
- Surface tension
- Spectrophotometry

Specific Application-Paks are available for use with life sciences applications, such as:

- Cell culture
- PCR
- Western blotting
- Sequencing
- Dissolution testing
- Proteomics
- Spectroscopy
- Genomics
- Immunoassays
- Microbiology

All Application POD-Paks feature:

- An e-Sure tag — for indispensable data traceability (*Learn more on page 11*)
- An ergonomic pack locker and protective bell — for easy 'snap-into-place' installation



Minimize wasted space. Magnify efficiency.

Versatile configurations give the best fit for your space

Because each lab is unique, the Milli-Q® IQ 7003/05/10/15 system lets you optimize valuable lab space to help maximize your efficiency.

You may choose to wall mount the purification unit and tank, store them under the bench, or a combination of both to suit your space requirements. Designed for easy integration, the units can be tucked into a corner, high up on a wall, or installed at a distance in a lab cabinet. There's no need to install near a sink and the tank does not require a drain.

Only the slim and neatly connected E-POD® and Q-POD® dispensers remain on the bench. Up to 4 POD dispensers can be supplied by a single purification unit, with an allowance of up to 5 m between PODs. This way, even scientists at distant benches — or even another lab — have access to purified water.

Cabling is available in customizable lengths and enclosed in protective sheathing for a neat, uncluttered installation.

Take advantage of optional accessories, including a foot pedal for hands-free water delivery.



The Milli-Q® IQ 7003/05/10/15 system is designed for easy integration almost anywhere in your lab.

Minimize effort. Magnify your time.

Effortless data traceability and paperless data management

Powerful, integrated data management makes it simpler and faster to manage water system data. All data generated by the Milli-Q® IQ 7003/05/10/15 system is stored in the system's memory, leaving no more log book or papers to archive.

Create customized reports in just a few clicks

- **Dispensing Events** is a history of all dispensing reports. You can determine water quality of an individual past event, assess the volume used over a specific time frame, or even allocate costs using the User ID field
- A **Daily Quality Measures Report** traces your water quality over time. Select a time frame to view a daily average of water quality parameters and volumes used

All reports can be exported and are available in an open format suitable for any LIMS (laboratory information management system). The archiving function supports quality management systems, a growing industry trend.

Password protection

Critical Milli-Q® IQ 7003/05/10/15 data can be protected with a password. When activated, only authorized users may access certain key data, such as system set points or configuration parameters.

- The **Complete History**, a global archive of ALL system data, is available when a more in-depth analysis is needed. This includes water quality and volumes and any events such as alerts, setting modifications, consumables replacement and other service activities

Ensure data traceability

e-Sure tags (based on RFID technology) are present on all consumables. These digital markings provide quality and safety assurance, as well as traceability. Thanks to e-Sure tags, consumables' data and the events throughout their life are automatically recorded in the system memory, and a current consumable's status can be monitored directly on the POD screen.

A graphic preview is available with the last 30 events; conveniently export data using the screen's USB port.



Minimize maintenance. Magnify your focus.

Experience effortless maintenance

Maintaining your Milli-Q® IQ 7003/05/10/15 system is worry-free and easier than ever. The system has everything under control and will notify you if:

- Consumables need replacing — you'll receive an alert and then your system will guide you step by step. Plus, the IPAK locker makes changing consumables simple. Just twist and lock. Anyone can do it!
- A technical issue is encountered — specific details will be provided for efficient troubleshooting.

In case of a serious issue, you are safe: your system will inform you and automatically stop.



 To order consumables, scan the QR code and automatically connect to: SigmaAldrich.com/mymilliqconsumables

Receive unequalled quality of support with Milli-Q® Services

Thanks to Milli-Q® Services, you can benefit from a range of services and service plans to help your system operate at optimum efficiency now and in the future. In all their activities, our certified field service engineers follow strict standard procedures, use only genuine parts, and provide a formal service report in line with quality assurance guidelines.

Qualification expertise

Our full Qualification Program is designed to support laboratory validation procedures. The program includes qualification workbooks with IQ, OQ, MP (maintenance procedures) and examples of PQ files. In addition, on-board resistivity meters and thermistors, as well as the A10® TOC monitor, allow USP and EP suitability tests to be performed. Certificates of Conformity, Quality and Calibration are available to facilitate GLP and cGMP compliance.

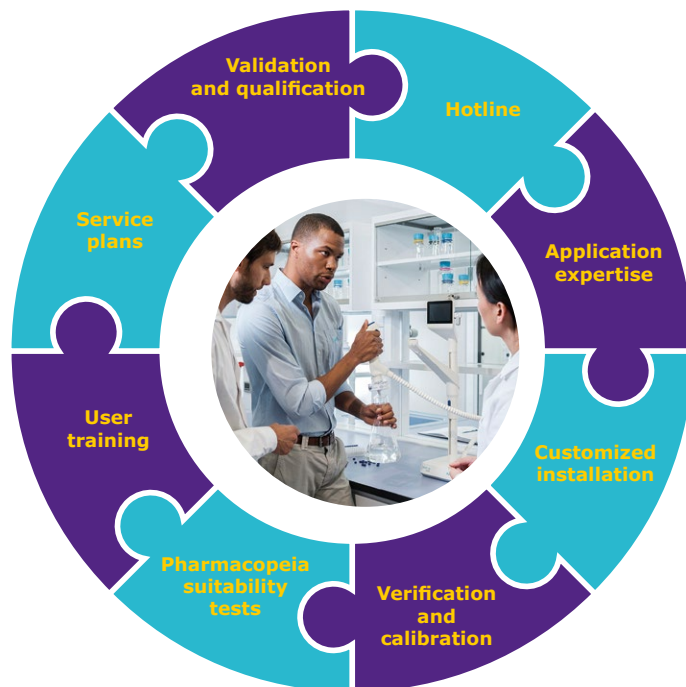

Minimize waste. Magnify sustainability.

Committed to environmental sustainability

We are committed to environmental sustainability. Our lab water solutions are developed with the dual objectives of:

- Increasing our own sustainability
- Helping our customers move toward sustainable solutions themselves

First and only completely mercury-free solution

The Milli-Q® IQ 7003/05/10/15 system is the first and only completely mercury-free tap-to-ultrapure water system on the market with built-in ech_2o ® UV lamps. Not only are these lamps mercury free, but they are also more compact than previous UV lamps, allowing for a smaller overall system.



Mercury free

Smaller footprint means reduced waste and more space

We have worked hard to reduce the size of the system, tank and consumables:

- System size is 26% smaller for Milli-Q® IQ 7003 and IQ 7005 systems, and 12% smaller for Milli-Q® IQ 7010 and IQ 7015 systems vs. prior baseline Milli-Q® Integral systems
- New tank is more compact and has a better integrated vent filter to give an easier fit in limited space
- Plastic for purification cartridges has been reduced by 33% on Milli-Q® IQ 7003 and IQ 7005 systems thanks to innovative IQnano® ion-exchange media

All these changes reduce manufacturing plastic needs, packaging and transportation, as well as waste levels. Plus, you gain valuable lab space!

Save water and energy

Advanced RO purification, with its RO recovery loop, optimizes water recovery and reduces water consumption. Plus, a unique embedded and improved Lab Close mode lets you put the system into hibernation when the lab is closed for extended periods. Water quality is preserved with only minimum water and electricity consumption.

Supports a paperless environment

The system is designed to facilitate paperless data management, with documentation available online. The system is delivered with its relevant certificates (see *next page*) and a quick reference guide that contains hints and tips on system functions. The user manual can easily be downloaded from the POD screen.

Greener Alternative Products



The Milli-Q® IQ 7003 and IQ 7010 systems have been evaluated on 7 dimensions that have a critical impact on Global Warming: Energy & Emissions, Water, Packaging, Materials, Suppliers & Manufacturing, Circular Economy, and Usability & Innovation. Officially awarded the Greener Alternative Product label, we certify that the Milli-Q® IQ 7003 and IQ 7010 systems use less plastic and less electricity, and are completely mercury free.

Access the "Design for Sustainability" scorecards for the Milli-Q® IQ 7003 & 7010 systems at SigmaAldrich.com/milli-q-iq7003-05-10-15



Compliance with Quality Assurance demands.

Our products are manufactured in an ISO 9001 and ISO 14001-registered production site and their certificates are available on demand. To assist you in following industry requirements, specific certification documents are also available:

Certificate of Conformity:

The system has been assembled and tested to our stringent Quality Assurance procedures.

Certificates of Calibration:

Included for the built-in resistivity and temperature meters and the A10[®] TOC monitor.

Certificate of Quality:

Included with all our consumables which have been validated to consistently deliver the water quality expected.

Get instant online access to your certificates of quality at SigmaAldrich.com/mymilliqconsumables

Water quality compliance

Ultrapure and pure water produced by the Milli-Q[®] IQ 7003/05/10/15 system meets or exceeds requirements described by the organizations below:

Organization	Pure water quality / grade	Ultrapure water quality / grade
European Pharmacopoeia	Purified water	Purified water in bulk
U.S. Pharmacopeia	Purified water	Purified water in bulk
Japanese Pharmacopoeia	Purified water	Purified water
Chinese Pharmacopoeia	Purified water	Purified water
ASTM [®] D1193	Type II water	Type I water, Grade B
ISO 3696	Grade 2 water	Grade 1 water
Chinese National Standard GB/T 6682	Level 2 water	Grade 1 water
Chinese National Standard GB/T 33087	N/A	Ultrapure water
JIS K 0557	A3 water	A4 water
Clinical and Laboratory Standards Institute [®] (CLSI [®])	N/A	Clinical Laboratory Reagent Water (CLRW)

N/A, not applicable.

TECHNICAL APPENDIX

Milli-Q® IQ 7003/05/10/15 Water Purification Systems





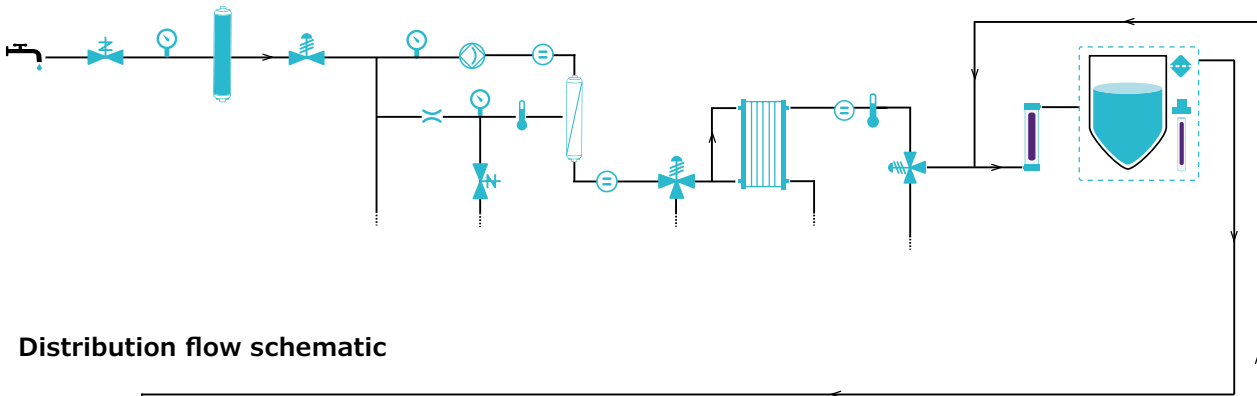



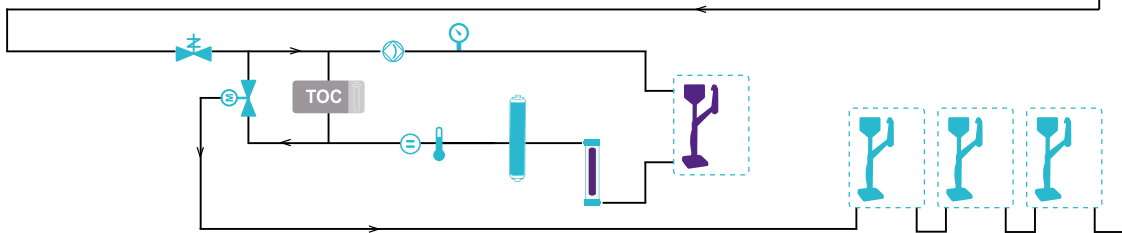











The Milli-Q® IQ 7003/05/10/15 system uses regular tap water as feed to produce pure (Type 2) and ultrapure (Type 1) water. A pure water storage tank feeds the distribution loop to deliver pure and ultrapure water to independent E-POD® and Q-POD® dispensers, respectively.

Production flow schematic



Distribution flow schematic



- | | | | | | | | |
|---|-----------------|---|--------------------|---|----------------------------|---|--------------------------------|
|  | Tap feed water |  | Flow controller |  | Vent filter |  | Thermistor |
|  | Pressure sensor |  | Conductivity cell |  | Pump |  | Resistivity cell |
|  | Solenoid valve |  | Pressure regulator |  | Motorized valve |  | 3-way valve |
|  | Q-POD dispenser |  | E-POD dispenser |  | Elix EDI module |  | Storage tank
(25/50/100 L) |
|  | IPAK cartridge |  | RO membrane |  | ech ₂ o UV lamp |  | ech ₂ o ASM UV lamp |
|  | A10 TOC monitor | | | | | | |

Purification unit and storage tank specifications

Purification unit

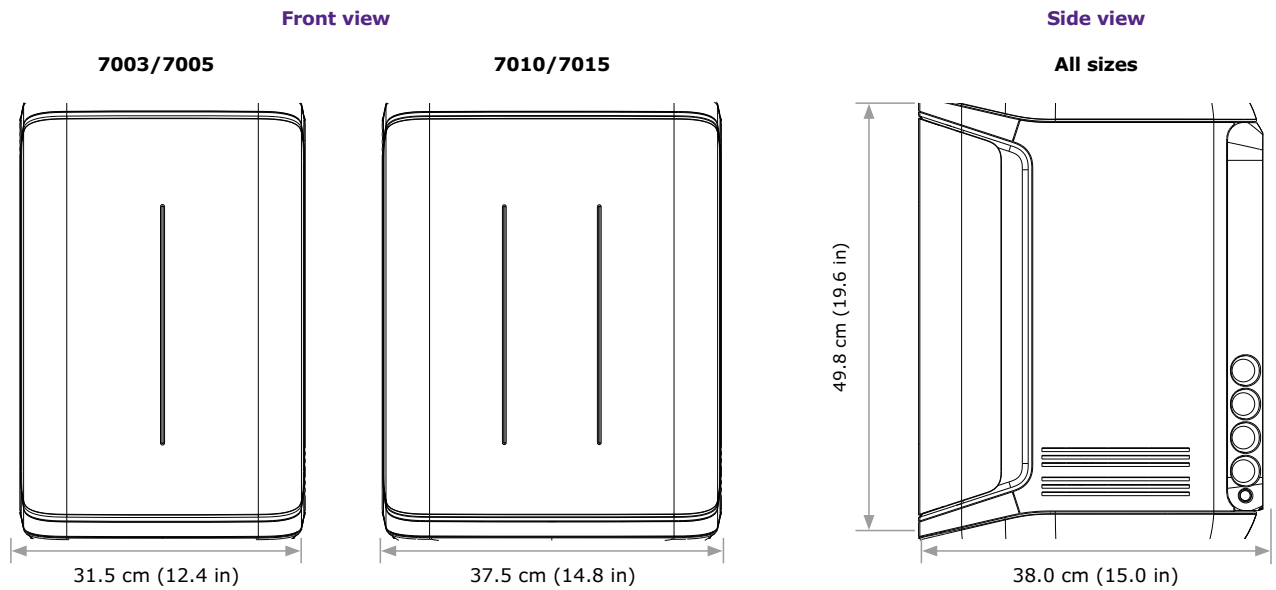

Storage tank

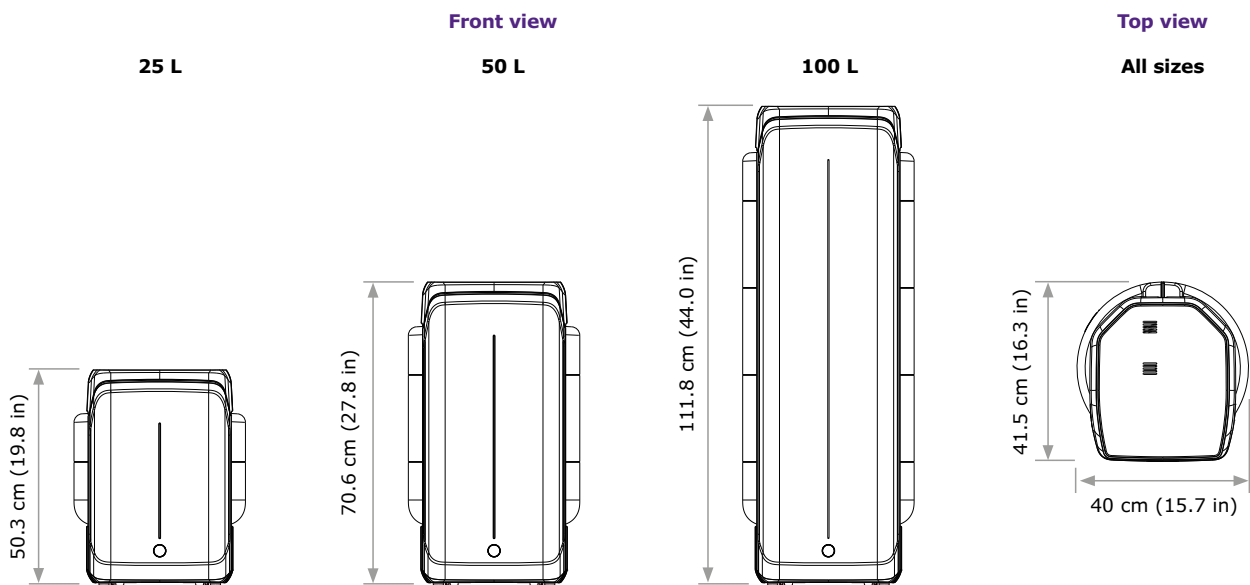

Tubing and port requirements

Parameter	Description
Feed water connection	½" Gaz
Distance from feed water port	Maximum 5 m (16.4 ft)
Distance from purification unit to POD dispenser	Maximum 5 m (16.4 ft)
Distance from purification unit to tank	Maximum 5 m (16.4 ft)
Power entry	Connection IEC 13
ON/OFF switch	Available on the unit
Water sensor port	Maximum 3.3 VDC
Tank level adapter port	Maximum 5 VDC
Ethernet port	IEEE P802.3

Electrical connections and specifications

Parameter	Description
Power source voltage	100–240 V ± 10%
Power frequency	50–60 Hz ± 10%
Power used	Maximum 600 VA
Power cord length	2.5 m (8.2 ft) plug: IEC13 female
Operational temperature	4–40 °C (39–104 F)
Altitude	Up to 3000 m (9842 ft)
RFID frequency	13.56 MHz
Tank material	High purity polyethylene

Weights

		Dry weight	Shipping weight	Operating weight
Purification unit	7003/7005	21.0 kg (46 lb)	24.0 kg (53 lb)	26.0 kg (57 lb)
	7010	23.7 kg (52 lb)	26.9 kg (59 lb)	29.7 kg (65 lb)
	7015	24.0 kg (53 lb)	27.2 kg (60 lb)	30.0 kg (66 lb)
Storage tank	25 L	6.7 kg (15 lb)	8.5 kg (19 lb)	31.7 kg (70 lb)
	50 L	7.6 kg (17 lb)	10.6 kg (23 lb)	57.6 kg (127 lb)
	100 L	10.9 kg (24 lb)	12.8 kg (28 lb)	110.9 kg (244 lb)

E-POD[®] and Q-POD[®] dispenser specifications

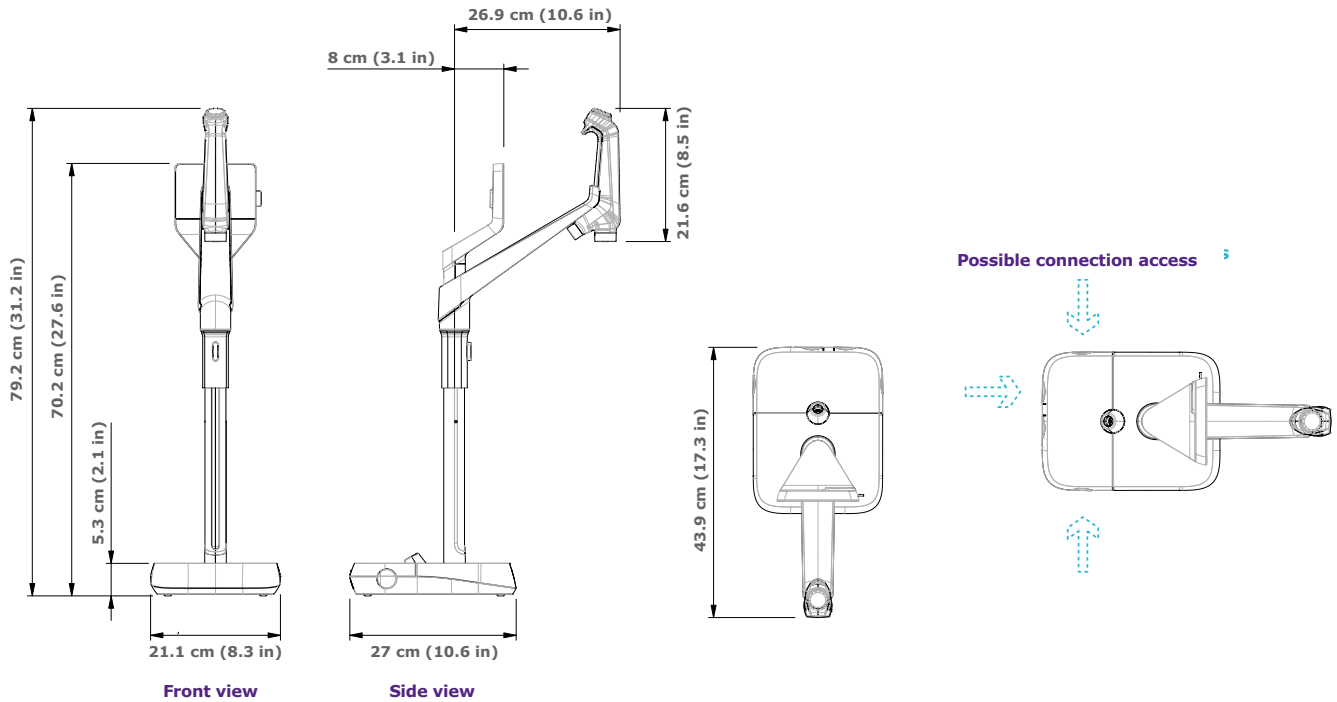

Tubing and port requirements

Parameter	Description
Dispenser tubing length	0.92 m (36.22 in)
Distance from purification unit to POD dispenser	Maximum 5 m (16.4 ft)
Distance between two POD dispensers (Maximum 4 dispensers connected in series)	Maximum 5 m (16.4 ft)
POD dispenser data connection with unit	Ethernet
Electrical connection	Powered by purification unit (24–28 VDC)
Foot pedal port	3.3 V

Weights

	Dry weight	Shipping weight	Operating weight
Q-POD [®] /E-POD [®]	4.7 kg (10.4 lb)	7.2 kg (15.9 lb)	5.5 kg (12.1 lb)

Screen description and functionalities

Parameter	Description
Capacitive touchscreen	Size: 5 in; Resolution: 800 x 480
USB port	USB 2.0 Highspeed standard
Speaker	Impedance: 8 Ω/max output power: 0.5 W
Display in 9 languages	Chinese/English/French/German/Italian/Japanese/ Portuguese/Russian/Spanish

Examples of installation options

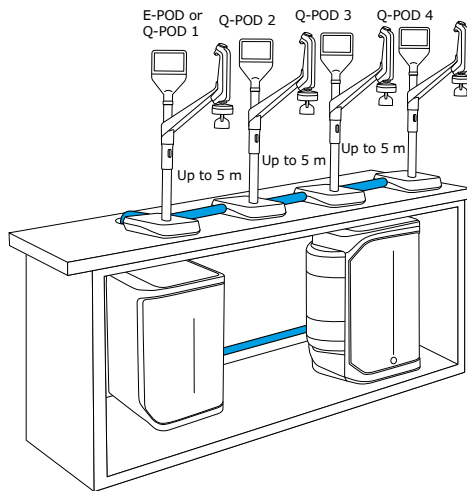

Up to 4 PODs connected

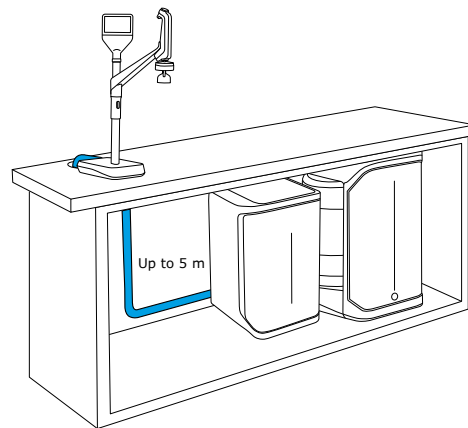

Under-bench installation

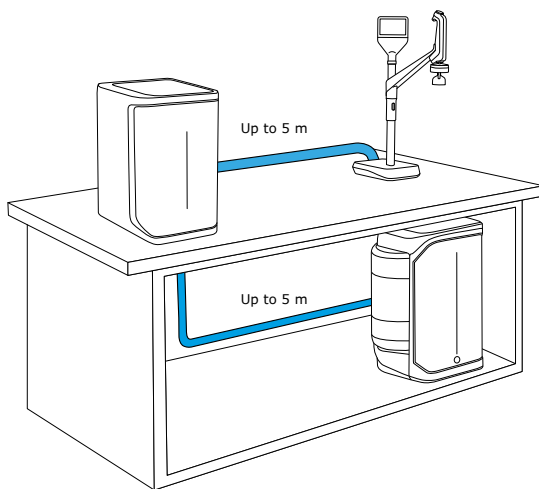

Bench-top and under-bench installation

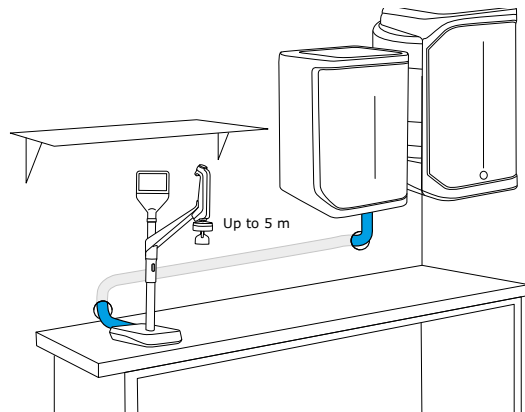

Wall-mounted installation

Water specifications international conformity

Feed water requirements	
Feed water	Potable tap water
Pressure	1–6 bar
Temperature	5–35 °C (41–95 F)
Conductivity	<2000 µS/cm at 25 °C
Dissolved CO ₂	<30 ppm
Free chlorine	<3 ppm
Fouling Index	<10
pH	4–10
Total Organic Carbon (TOC)	<1 ppm
Langlier Saturation Index (LSI)	<0.3
Hardness (as CaCO ₃)	<300 ppm
Silica	<30 ppm

Ultrapure, Type 1 water specifications ¹ (from Q-POD® dispenser)	
Resistivity at 25 °C ²	18.2 MΩ·cm
Conductivity at 25 °C	0.055 µS/cm
TOC	≤2 ppb (µg/L) ³ ; typically ≤5 ppb
Particles ⁴	No particles with size >0.22 µm
Bacteria ⁵	<0.01 cfu/mL (<10 cfu/L)
Pyrogens (endotoxins) ⁶	<0.001 EU/mL
RNases ⁷	<1 pg/mL
DNases ⁷	<5 pg/mL
Proteases ⁷	<0.15 µg/mL
Flow rate	Up to 2 L/min

1. These values are typical and may vary depending on the nature and concentration of contaminants in the feed water.
2. Resistivity can also be displayed non-temperature-compensated as required by USP.
3. In the appropriate operating conditions, otherwise typically ≤5 ppb.
4. With Millipak® or Millipak® Gold filter.
5. With Millipak® or Biopak® filter when installed and used in a laminar flow hood.
6. With Biopak® polisher when installed and used in a laminar flow hood.
7. With Biopak® polisher.

Pure, Type 2 water specifications¹

Resistivity at 25 °C ²	>5 MΩ·cm; typically 10–15 MΩ·cm
Conductivity at 25 °C	0.2 µS/cm; typically 0.1 µS/cm
TOC	≤30 ppb
Production flow rate	3 L/h (Milli-Q® IQ 7003) 5 L/h (Milli-Q® IQ 7005) 10 L/h (Milli-Q® IQ 7010) 15 L/h (Milli-Q® IQ 7015)

From an E-POD® dispenser with final filter, the following water quality specifications are achieved:¹

Particulates ³	No particles with size >0.22 µm
Bacteria ⁴	<0.01 cfu/mL (<10 cfu/L)
Pyrogens (endotoxins) ⁵	<0.001 EU/mL
RNases ⁶	<1 pg/mL
DNases ⁶	<5 pg/mL
Proteases ⁶	<0.15 µg/mL
Flow rate	Up to 2 L/min

1. These values are typical and may vary depending on the nature and concentration of contaminants in the feed water.
2. Resistivity can also be displayed non-temperature-compensated as required by USP.
3. With Millipak® or Millipak® Gold filter.
4. With Millipak® or Biopak® filter when installed and used in a laminar flow hood.
5. With Biopak® polisher when installed and used in a laminar flow hood.
6. With Biopak® polisher.

International regulation requirements

Declaration of CE and cUL Conformity

The Milli-Q® IQ 7003/05/10/15 system has been tested by an independent and accredited company for compliance with CE directives related to safety and electromagnetic compatibility. The report can be consulted on demand. In addition, the Milli-Q® IQ 7003/05/10/15 system is built using components and practices recommended by UL and has been cUL marked.

The registration can be verified on the UL web site: www.ul.com

We also meet the regulatory requirements of the following organizations:



Ordering information

Purification cartridges	Cat. No.
Milli-Q® IQ 7003-5 purification kit	IQ700XPKT1
Milli-Q® IQ 7003-5 purification kit H (for hardness)	IQ700XPKTH1
Milli-Q® IQ 7010-15 purification kit	IQ70XXPKT1
Milli-Q® IQ 7010-15 purification kit H (for hardness)	IQ70XXPKTH1
Vent Filter HF (for high-flow applications)*	TANKVH1A1

Application POD-Paks	Cat. No.
Millipak® 0.22 µm filter	MPGP002A1
Millipak® Gold 0.22 µm sterile filter	MPGPG02A1
Biopak® polisher	CDUFBI0A1
LC-Pak® polisher	LCPAK00A1
EDS-Pak® polisher	EDSPAK0A1
VOC-Pak® polisher	VOCPAK0A1

Accessories	Cat. No.
System wall mounting bracket	SYSTFIXA1
E-POD® / Q-POD® wall mounting bracket	WMBQP0D01
Tank wall mounting bracket	TANKFIXA1
Foot pedal	ZMQSFTSA1
Water sensor	ZWATSENA1
External solenoid valve for feed water	EXTSV00A1
Connector 2 m system to POD	ZFC0NNS2Q
Connector 5 m system to POD	ZFC0NNS5Q
Connector 2 m system to storage tank	ZFC0NN2ST
Connector 5 m system to storage tank	ZFC0NN5ST

System care options	Cat. No.
ROProtect C - Chlorine tablets	ZWCL01F50
EfferSan Effervescent Tablets (USA)	5874316024
EfferSan Effervescent Tablets (CAN)	5874316024C

*For flow rate >16.5 LPM.

Milli-Q®

Lab Water Solutions

MilliporeSigma
400 Summit Drive
Burlington, MA 01803

[SigmaAldrich.com/labwater](https://www.SigmaAldrich.com/labwater)

For more information, please visit our website:

[SigmaAldrich.com/milli-q-iq7003-05-10-15](https://www.SigmaAldrich.com/milli-q-iq7003-05-10-15)

© 2021 Merck KGaA, Darmstadt, Germany and/or its affiliates. All Rights Reserved. MilliporeSigma, the vibrant M, Milli-Q, Q-POD, E-POD, Elix, ech₂o, IPAK Gard, IPAK Quanta, IQnano, A10, Millipak, BioPak, VOC-Pak, EDS-Pak and LC-Pak are trademarks of Merck KGaA, Darmstadt, Germany or its affiliates. All other trademarks are the property of their respective owners. Detailed information on trademarks is available via publicly accessible resources.

Lit. No. MS_BR2157US Ver. 1.0 34705 02/2020