

Steritest™ Canisters Carrying Trays (SYMBCAN08) & their Rack (SYMBRACK2) User Quick Guide

1

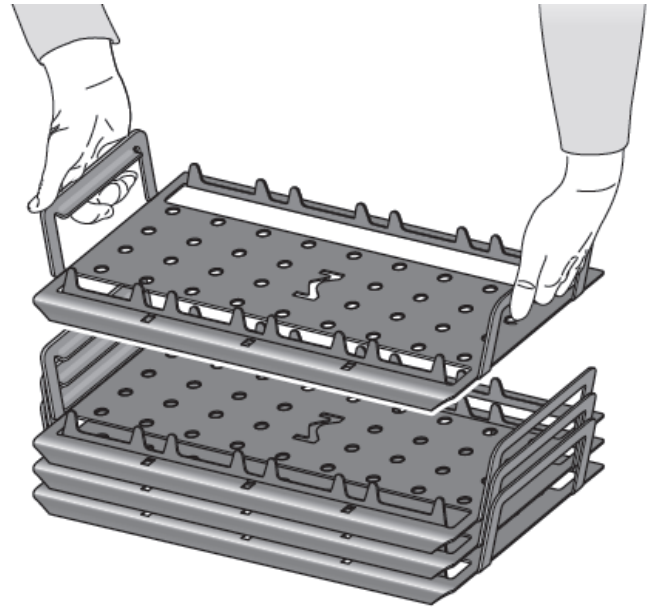

2

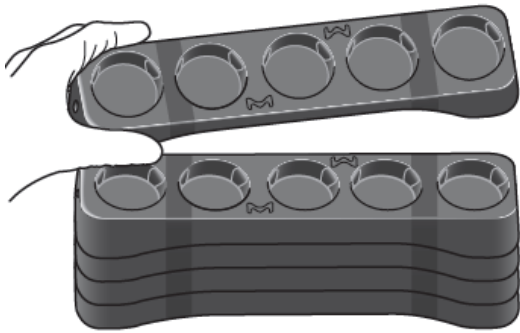
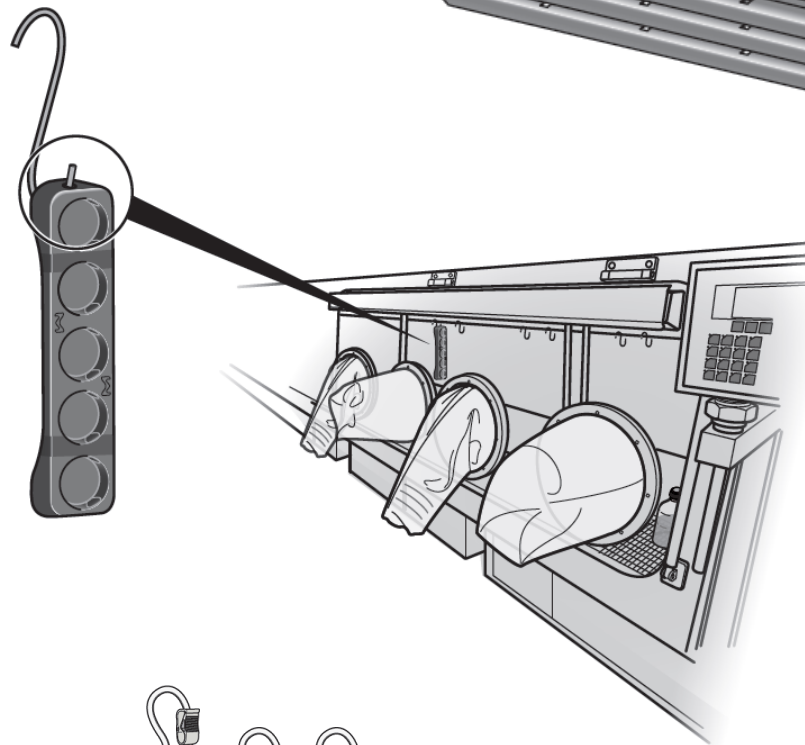

3

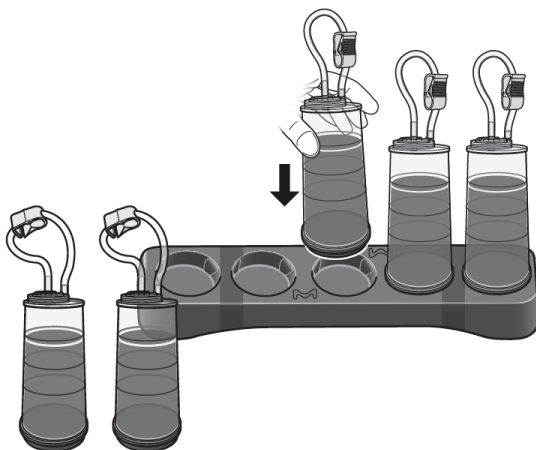

4

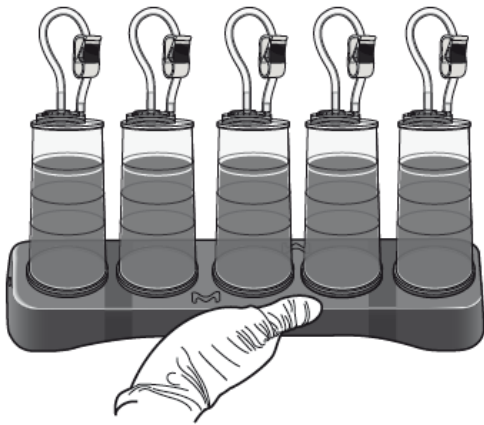
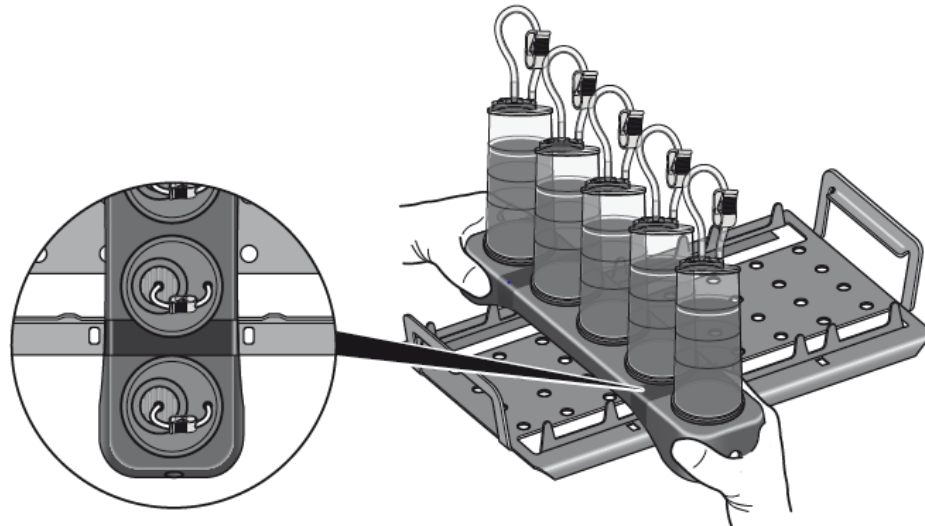

5

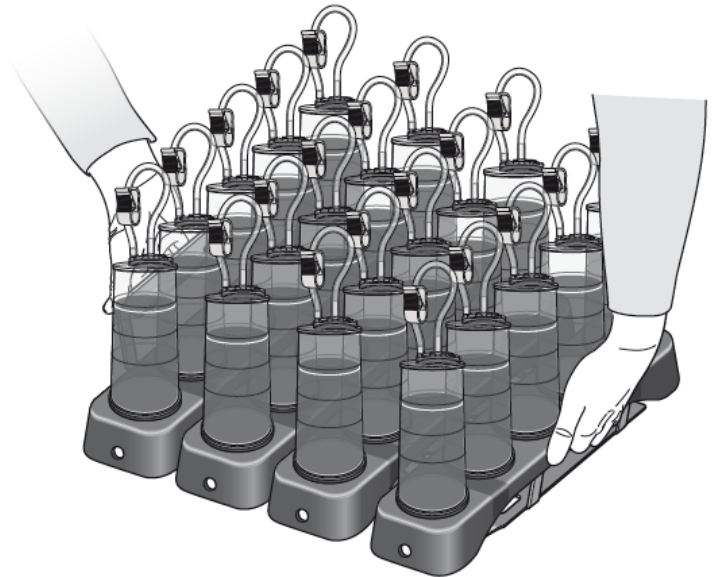

6

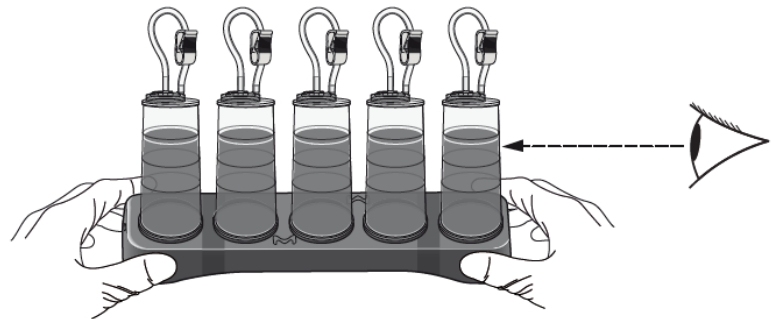
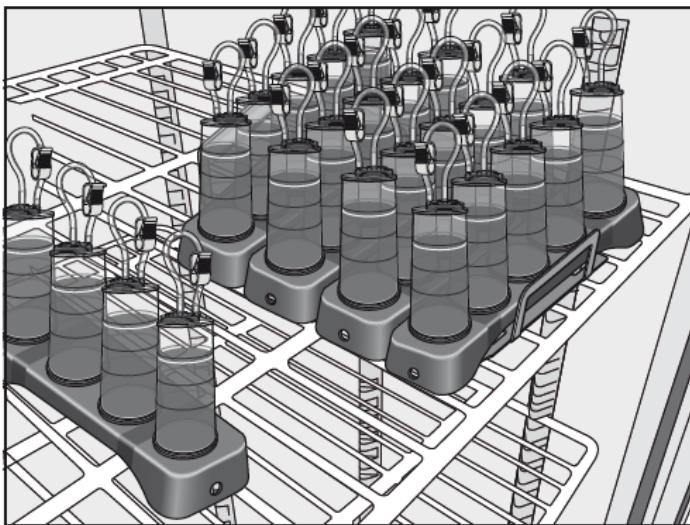

Steritest, MilliporeSigma, Millipore, and Sigma-Aldrich are trademarks of Merck KGaA, Darmstadt, Germany or its affiliates. Detailed information on trademarks is available via publicly accessible resources.

© 2019 Merck KGaA, Darmstadt, Germany and/or its affiliates. All Rights Reserved.

The life science business of Merck KGaA, Darmstadt, Germany operates as MilliporeSigma in the US and Canada.