

HPLC and UHPLC Column Selection Guide

The comprehensive
Supelco® portfolio of analytical
solutions to meet your
U/HPLC and LC-MS needs



Table of contents

Our HPLC and LC-MS Workflow	4
Supelco® HPLC and UHPLC Column selection	5
Stationary phases at a glance	6
Selection of stationary phase carrier by their benefits	8
Selection of phase bonding by compound class	9
Selection by Chemical Structure of the Analyte using the log P Value	10
Selection of Chromatographic mode and Stationary Phase by log P Value	12
Selection by Specific Chromatographic Need (C18)	13
Selection by USP classification	14
Selection by Column Dimension	20
HPLC Columns hardware	22
Column Accessories and Pre-column Holder	24
Fused-Core® (Superficially Porous Silica Particles, SPP) HPLC and UHPLC columns	26
Ascentis® Express HPLC and UHPLC Columns	28
BIOshell™ HPLC and UHPLC Columns for Biomolecule Separation	38
Monolithic Silica HPLC Columns	46
Chromolith® and Chromolith® HR HPLC Columns	50
Chromolith® WP 300 HPLC Columns for Biomolecule Separation	54
Fully Porous Particulate Silica (FPP) Columns	60
Purospher™ STAR HPLC and UHPLC Columns	62
Discovery® HPLC Columns	70
Discovery® BIO	74
Ascentis® HPLC Columns	76
Titan™ UHPLC Columns	80
SeQuant® HILIC HPLC and Capillary Columns	82
LiChrospher® HPLC Columns	86
Superspher® HPLC Columns	88
LiChrosorb® HPLC Columns	89
SUPELCOSIL™ HPLC Columns	90
Chiral HPLC Columns	94
Biomacromolecule Characterization: A Multipronged Separation Challenge	100
Sepax Technologies: HPLC Columns for Bioanalysis	102
Ion Exchange Chromatography	104
Hydrophobic Interaction Chromatography (HIC)	106
Affinity Chromatography	112
Synthetic Carbons for Chromatographic Applications	114
Customized Packings	120

The Supelco® portfolio of analytical solutions is developed by analytical chemists for analytical chemists to ensure your results are accurate, precise and reproducible. Every product is meticulously quality controlled to maintain the integrity of your testing protocols and, with our dedicated scientists, the expertise you need is always on hand.

We provide a premier selection of proven analytical tools and consumables that meet the requirements of scientists who primarily use HPLC and LC-MS for separation and analysis of drugs and biomolecules, or for other analytical assays. Our selection of columns, solvents, standards and sample preparation products are exclusively designed for HPLC and LC-MS, meeting the critical need for purity.

Our HPLC and LC-MS Workflow



Supelco® HPLC and UHPLC Columns

Our HPLC & UHPLC column portfolio meets today's challenging needs of Fast HPLC including UHPLC, LC-MS, biopolymer separation, high pH conditions, as well as traditional pharmacopeia and agency methods within pharmaceutical, environmental, clinical, and food industries etc. – from nano LC to semi-preparative applications

Fused-Core® technology, monolithic silica, ultra-pure and monodisperse silica, and polymeric particles are some of the particle platforms that make up the Supelco® HPLC product line so you can find the right column for your specific application.

We have a tradition of providing innovative HPLC Columns; while our trusted SUPELCOSIL™, LiChrospher®, Discovery®, Ascentis®, SeQuant® and Purospher™ STAR columns have a proven track record, our Purospher™ STAR and Titan™ columns deliver leading edge UHPLC performance at an affordable cost, and Ascentis® Express and BIOshell™ (based on Fused-Core® technology) have the capability to turn any HPLC system into a Fast HPLC workhorse. Chromolith® HPLC and UHPLC columns, based on monolithic silica, enable rapid separations at extremely low column

backpressure and provide a very high matrix-tolerance making this material perfectly suitable for the separation of matrix-rich samples.

Our extensive range of chiral HPLC & LC-MS columns, derivatization reagents and mobile phase additives make us one of the leaders in chiral chromatography technology. Our comprehensive range of well-respected brands includes Astec® CHIROBIOTIC®, CYCLOBOND™, ChiraDex®, and CLC columns.

We can help you find a solution for your chiral separation application, including clinical, food, environmental, or drug discovery. Depending on your chromatography needs, our chiral columns can be used with several of the most common mobile phase modes, and many are suitable for LC-MS.















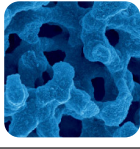



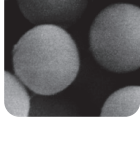







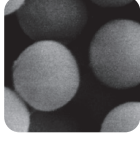

NEW

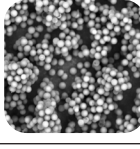
Supel™ Carbon HPLC columns enable the use of extreme pH and temperature without a compromise in efficiency. This column is an excellent choice for the retention and separation of polar compounds using reversed phase conditions

Supel™ Carbon HPLC Columns

Stationary Phase Carrier

		Stationary phase base material	Methods / Use		Separation mode	Solution for small molecule separation		Page	Solution for Biomolecule separation	Page		
Silica based stationary phases												
<p>Type B</p> $\begin{array}{c} \text{Si}(\text{OC}_2\text{H}_5)_4 \\ \downarrow \\ [-\text{Si}(\text{OC}_2\text{H}_5)_2-\text{O}- \\ \text{Si}(\text{OC}_2\text{H}_5)_2-\text{O}-]_n \\ \downarrow \\ \begin{array}{c} [-\text{Si}-\text{O}-\text{Si}-\text{O}-] \\ \quad \\ \text{O} \quad \text{O} \\ [-\text{Si}-\text{O}-\text{Si}-\text{O}-] \end{array} \\ \downarrow \\ \text{SiO}_2 \end{array}$ <ul style="list-style-type: none"> NO Metal content Provides optimal peak shape for basic and chelating compounds 		<p>Superficially porous silica particles (SPP) / Fused-Core®</p> <p>SPP - Superficially porous silica HPLC and UHPLC columns provide very high efficiencies, which are typically 40% higher in comparison to fully Porous Particles of the same particle size.</p>	First choice for new methods under development or during method transfer in Pharma. Excellent for UHPLC applications (2 µm particles)	Silica SPP		Reversed Phase HILIC	Ascentis® Express HPLC Columns UHPLC columns Capillary columns	 	28	BIOshell™ HPLC Column UHPLC columns Capillary columns	 	38
		<p>Monolithic silica</p> <p>Monolithic silica HPLC, UHPLC and semi-preparative columns enable rapid separations at very low column back-pressure with very high matrix-tolerance and extended column lifetime.</p>	Best choice for matrix-rich samples and applications where lifetime and robustness is a concern. As well for rapid separations at low column backpressure.	Monolithic silica		Reversed Phase HILIC Affinity	Chromolith® HPLC columns Capillary columns Semi-preparative Columns	 	50	Chromolith® WP 300 HPLC columns	 	54
		<p>Fully porous silica particles (FPP) Type B (high purity silica)</p> <p>Fully porous silica particles provide the full loadability of the stationary phase due to its fully porous physical characteristics. This ensures high sensitivities because the peak broadening effect of overloading the stationary phase is minimized. Type B silica particles are produced from tetraalkoxysilane in a sol-gel process. This metal free stationary phase base material can be used for the analysis of acidic, basic, and chelating compounds providing excellent peak symmetries with less need for strong buffer concentrations.</p>	For established HPLC methods, for special selectivities such as HILIC and Chiral as well as columns for biomolecule separation They are in use in thousands of methods and ensure reliable results over the complete range of use, particle sizes and column dimensions in Nano-LC (Capillary columns) UHPLC Analytical HPLC Semi-preparative LC Preparative LC	Silica FPP		Reversed Phase HILIC Normal phase	Purospher™ STAR HPLC and UHPLC columns Discovery® HPLC columns Semi-preparative Columns Ascentis® HPLC columns Titan™ UHPLC columns SeQuant® HILIC HPLC columns and capillary columns	         	62 70 76 80 82	Discovery® BIO HPLC columns Capillary columns		74
					Silica FPP		Chiral	Astec® Chiral HPLC and UHPLC columns				
				Silica FPP		Size Exclusion Ion Exchange HIC				Sepax U/HPLC columns TSKgel® U/HPLC columns		102 107
<p>Type A</p> $\begin{array}{c} \text{M}_2\text{O} - n\text{SiO}_2 \quad \text{M}=\text{Na}, \text{K}, \text{Fe} \\ \downarrow \\ [-\text{Si}(\text{OH})_2-\text{O}- \\ \text{Si}(\text{OH})_2-\text{O}-]_n \\ \downarrow \\ \begin{array}{c} [-\text{Si}-\text{O}-\text{Si}-\text{O}-] \\ \quad \\ \text{O} \quad \text{O} \\ [-\text{Si}-\text{O}-\text{Si}-\text{O}-] \end{array} \\ \downarrow \\ \text{SiO}_2 (\text{Na}, \text{K}, \text{Fe}) \end{array}$ <ul style="list-style-type: none"> Contains metals Peak-Tailing for basic and chelating compounds 		<p>Fully porous silica particles (FPP) Type A (conventional silica)</p> <p>Spherical Traditional silica made from sodium waterglass established in many applications and methods.</p>		Silica FPP		Reversed Phase Normal Phase HILIC Ion Exchange	LiChrospher® HPLC columns Semi-preparative Columns Superspher® HPLC columns SUPELCO SIL™ HPLC columns Semi-preparative Columns		86 88 90			
		<p>Irregular</p> <p>Reliable stationary phase providing same properties for HPLC and large scale preparative LC (bulk sorbent) as well as TLC</p>			Silica FPP irregular		Reversed Phase Normal Phase	LiChrosorb® HPLC columns Semi-preparative Columns Bulk sorbent		89		
Other stationary phase materials												
		<p>Carbon particles</p> <p>Fully porous graphitic carbon (PGC) particles manufactured using a patented synthetic process, enable extreme pH and temperature stability without a compromise in efficiency.</p>	Excellent choice for the retention of separation of polar compounds using reversed phase conditions.	Porous Graphitic Carbon		Reversed Phase	Supel™ Carbon	 	114	Supel™ Carbon	 	
		<p>Fully porous polymeric particles</p> <p>Enable the use of the full pH-range for the mobile phase (0-14)</p>		Polymeric FPP		HILIC Reversed Phase Size Exclusion Ion Exchange HIC	apHera™ HPLC columns SUPELCOGEL™ HPLC columns Hamilton® HPLC columns SeQuant® ZIC®-pHILIC	 	118 82	Cytiva FPLC and HPLC columns TSKgel® HPLC and UHPLC columns		107
		<p>Zirconia and Alumina Particles</p> <p>Outstanding thermal and pH stability.</p>					Discovery® Zr HPLC Columns Aluspher® HPLC columns		119			

Note: As chromatographic separation depends on many physical and chemical parameters, we cannot guarantee the success of a separation based on the recommended column modification.



1st choice for method development



Recommended for LC-MS use

Selection of stationary phase carrier by their benefits

The performance of HPLC columns has improved dramatically in recent years, particularly in terms of separation power as measured by the number of theoretical plates per meter. The improvement in performance has been achieved primarily by a reduction in particle size.

Superficially Porous Particles (SPP) show higher separation efficiencies than Fully Porous Particles (FPP) with the same particle size. To achieve this very high efficiency it is essential to avoid any column overloading that could cause peak broadening effects.

HPLC columns filled with small and very small particles can be plugged or blocked more easily. Matrix-rich samples require extensive sample preparation when analyzed with HPLC and UHPLC columns using small particles. This added sample preparation step is a substantial time and cost factor. When analyzing challenging, matrix-rich samples, the benefit of monolithic silica columns is significant.

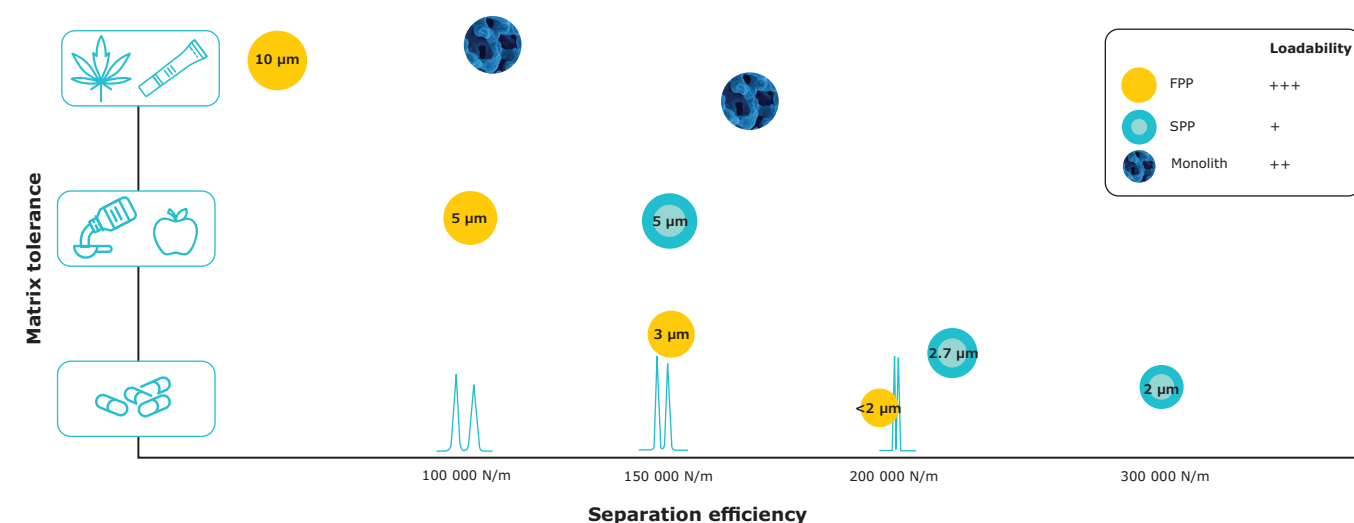

Need for Speed

Plates per pressure (N/bar)

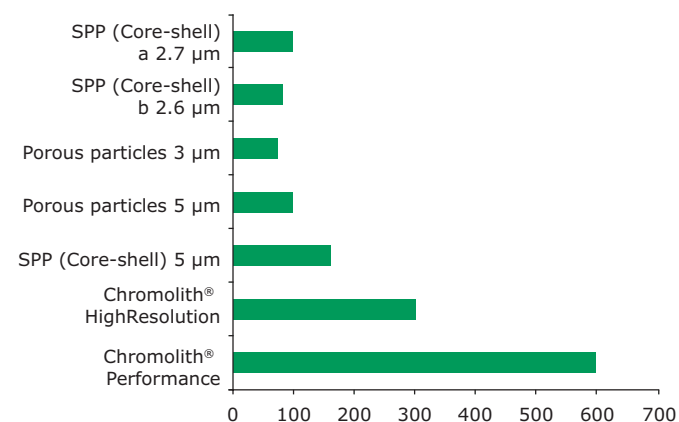

All columns are C₁₈ modified, 100-4.6 mm. Sample: anthracene, eluted isocratically using acetonitrile/water (60/40) at 2 mL/min flow rate. Injection volume: 5 µL, detection at 254 nm UV. All analyses performed at room temperature.

It goes without question that the development of faster separation processes is one of the most important issues in HPLC. Particularly in industry, chromatographers wish to speed up separations, and analyze more samples with the limited financial and human resources available. One of the main issues preventing speed is congestion. With conventional particle-packed HPLC columns, higher efficiency always comes at the expense of higher back pressure. Even core-shell particle (equal to SPP) columns, which are designed for lower resistance, still exhibit rather high back pressure. Hence, the task is to minimize back pressure in order to maximize speed.

Selection of stationary phase bonding by compound class





Selecting the most suitable column is highly dependent upon the sample undergoing analysis. Compound structure, solubility, and log P values of analytes all need to be taken into consideration when selecting column phase chemistry and mode of separation. While compounds can often be separated using various column chemistries, some column selectivities are better suited than others for certain compound classes. The table below shows a selection of classes of compounds typically analyzed by HPLC methods.

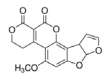

Compound Class	ZIC®-HILIC	ZIC®-cHILIC	ZIC®-pHILIC	NH ₂	Si	OH5	DIOL	CN	F5	RP-Amide	Propyl Phenyl	Phenyl Hexyl	Biphenyl	RP-4	RP-8	RP-8e	RP-18	RP-18e	PAH	C30	
Aflatoxins					2											2	2	1	1		
Alcohols	1	1		2		1	2	2		2							2	2			
Aldehydes											2	2				2	2	1	1		
Alkaloids	2	2							1		2	2				2	2	1	1		
Aliphatic amines	1	2							1	1								2	2		
Amino Acids	1	1				1	1									2	1	2	2		
Antibiotics	2	2							1		2	2	1	2	2	2	2	1	1		
Aromatic amines	1	2							1		1	1	1					2	2		
Carboxylic acids	2	1	2	1		2				1											1
Carotenoids					1		1									2	2	2	2		
Catecholamines										2								1	1		
Explosives										2								1	2		
Oils					1		2	2										2	2		
Oligonucleotides																		1	1		
Esters	2	2				2										2	1	1	1		1
Fat soluble vitamins				1	1						2	2	2					1	1		
Lipids	2	2			1													1	1		
Fatty acids					1											2	2	1	1		
Flavonoids			2		2			1			1	1	1					1	1		
Glycans	1	1	1		2	2												1	1		
Glycols	1	1			2	1	2	2													
Inorganic ions	1	1	1	2																	
Ketones					2						2	2				2	2	1	1		
Nitrosamines	1	1				1										2	2	1	1		
Nucleosides																2	2	1	1		
Nucleotides	1	1	1	1	2						2	2						2	2		
PAH											1	1						1	1		1
PCB											2	2				2	2	1	1		
Peptides	1	1	2		1						1	1		2	2	2	1	1			
Pesticides	2	2											2					1	1		
Phenols			2					1	1	1						2	2	1	1		
Phospholipids	1	1			2		2			2								2	2		
Phthalates								1										1	1		
Preservatives											1	1	2					1	1		
Proteins													2	1	1	1	2	2			
Organic phosphates	1	1																2	2		
Steroids				1	2			1			2	2	2		2	2	1	1			
Metabolized steroids	2	2									2	2	2		2	2	1	1			
Sugars	2	2	1	1	2	1			1												
Sugar Alcohols	1	1	2	2	1															1	1
Sulfonamides	2				2	2	2													1	1
Sweeteners	1	1		1	1						2	2	2						1	1	
Water soluble vitamins	1	1		1	1	1														1	1

1 Most suitable column 2 Possible alternative column

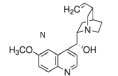
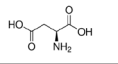
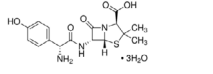
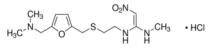
Selection by Chemical Structure of the Analyte using the log P Value

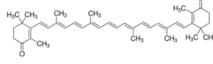
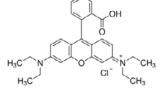
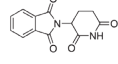
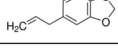
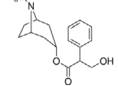
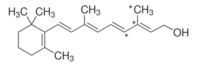
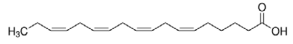
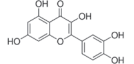
The selection of the most appropriate stationary phase depends on the chemical structure of the compound to be separated. One important parameter that describes the chemical structure of a compound is the log P value (water octanol logarithmic partition coefficient). This table shows the log P value of representative compounds of important analyte groups.

Analyte group	Example	Structure	log P value
A	Aflatoxins	Aflatoxin G1 	1.8
	Alcohols	Ethyl alcohol <chem>CH3CH2OH</chem>	-0.1
	Aldehydes	Benzaldehyde 	1.5
	Alkaloids	Quinine 	2.9
	Amino Acids	Aspartic acid 	2
	Antibiotics	Amoxicillin 	-2
		Ranitidine 	0.3
	Aromatic amines	Aniline 	0.9
	C	Carboxylic acids	Glucuronic acid 
Carotenoids		Canthaxanthin 	11.4
D	Dyes	Rhodamine 	4.4
E	Enantiomers	Thalidomide 	0.3
	Essential oils	Safrole 	3
	Esters	Atropine 	1.8
F	Fat soluble vitamins	Retinol 	5.7
	Fatty acids	Stearidonic acid 	5.9
	Flavonoids	Quercetin 	1.5

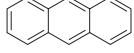
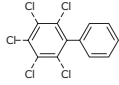
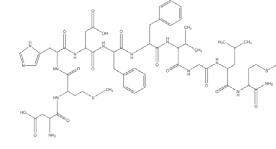
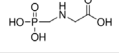
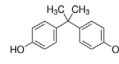
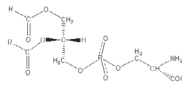
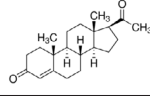
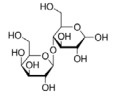
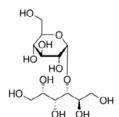
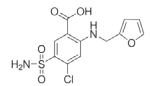
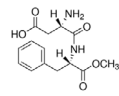
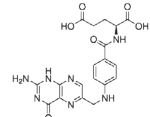
Analyte group	Example	Structure	log P value
G	Glycols	Ethylene glycol <chem>HOCH2CH2OH</chem>	-1.4
I	Inorganic ions	Chloride <chem>Cl-</chem>	0.8
K	Ketones	Cyclohexanone 	0.8
N	Nitrosamines	N-Nitrosodimethylamine 	-0.6
P	PAH	Anthracene 	4.4
	PCB	Pentachlorobiphenyl 	7.3
	Peptides	Neurokinin B 	-1.6
	Pesticides	Glyphosate 	-4.6
	Phenols	Bisphenol A 	2.2
	Phospholipids	Phosphatidylserine 	-3.5
S	Steroids	Progesterone 	3.9
	Sugars	Lactose 	-4.7
	Sugar Alcohols	Maltitol 	-5.2
	Sulfonamides	Furosemide 	2
	Sweeteners	Aspartame 	-2.7
W	Water soluble vitamins	Folic Acid 	-1.1

Selection of Chromatographic Mode and Stationary Phase by log P Value

C18 is usually the first choice for starting a new method. However, when a C18 doesn't give the desired separation, or your sample contains compounds that are known to be difficult to retain or resolve on a C18, then you should consider changing the stationary phase, modification or both.

If a compound is predominantly hydrophobic with a positive log P value (water octanol logarithmic partition coefficient), then the use of a reversed phase column is recommended. For low/medium polarity analytes, normal phase HPLC or HILIC are viable techniques.

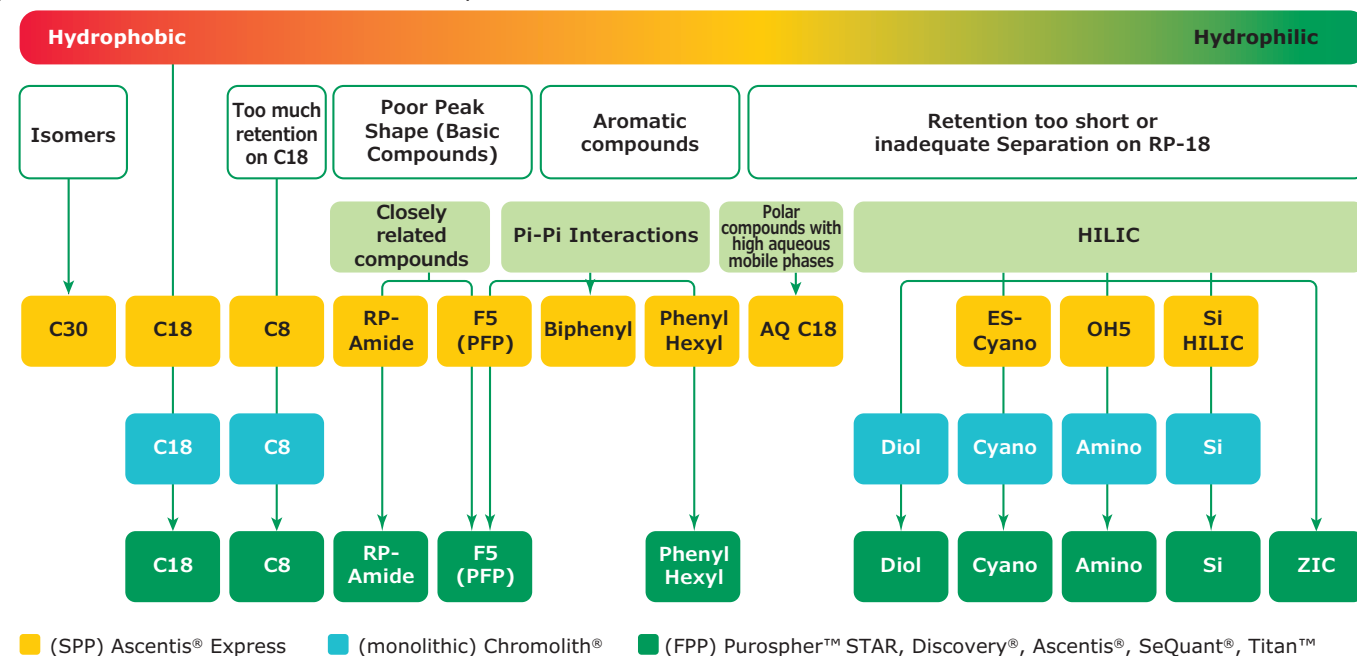

Choose the right HPLC column

Chromatographic resolution is most influenced by the selectivity (α) (when $k > 2$ and $N > 3000$). Changing the mobile phase composition or the stationary phase, is the most powerful way of optimizing selectivity whereas the particle size, pore size, length of the column, temperature, mobile phase strength have much less effect. Therefore, if satisfactory results are not met, or no retention is achieved, it is better to change to another selectivity using a different column type and/or a different mobile phase.

Resolution is mainly controlled by selectivity

Resolution (R_s or R) is impacted by three parameters (k , α , and N) which are directly related to experimental conditions. k is the average retention factor for the two bands, N is the number of theoretical plates and α is the separation factor (or selectivity factor).

The parameters k and α are determined by the experimental conditions (composition of the mobile phase; stationary phase chemistry and temperature), and N is affected by column length, particle size and pore size.

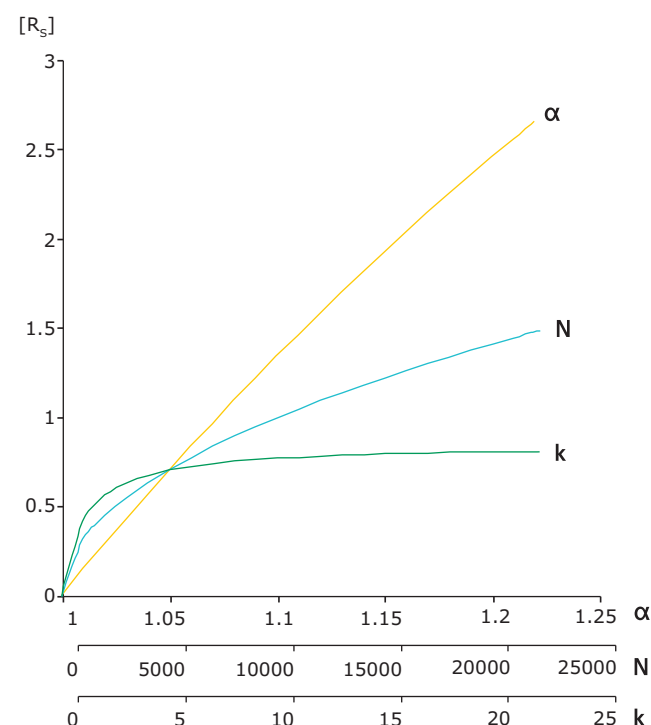

Selection by Specific Chromatographic Need (C18)

Prioritizing specific needs helps to select the best suitable column material for different chromatographic demands. Depending on the sample, analyte or matrix, the lab environment (e.g. instrumentation) and the separation goal, the best column choice can be very different from task to task. While the selection of the column chemistry is the first step in this process, the next step is to determine the most suitable column material. Many different selectivities are available based on different column materials. Nevertheless, C18 is still the most widely used column modification. The table below lists a selection of specific needs in HPLC on column materials with C18 modifications. The ranking is from 1 (lowest ranking) to 5 (highest ranking).

Need	Fused Core Silica (SPP)		Monolithic Silica		Fully porous silica particles (FPP) Type B					FPP Type A			
	Ascentis® Express C18	Ascentis® Express AQ C18	RP-18e	HR RP-18e	Purospher™ STAR RP-18e	C18	HS-C18	Ascentis® C18	Titan™ C18	Superspher® RP-18 (e)	LiChrospher® RP-18 (e)	LC-18	LC-18-DB
Particle size (µm)	2, 2.7, 5	2, 2.7, 5			2, 3, 5	3, 5, 10	3, 5, 10	3, 5, 10	1.9	4, 5, 10	3, 5, 10	3, 5, 12	3, 5
Separation efficiency	5, 5, 4	5, 5, 4	3	4	5, 4, 3	2, 3, 2, 1	4, 3, 2	5	3	2, 1, 3	2, 1, 3	2, 1, 3	2, 1, 3
Peak symmetry	5, 5, 5	5, 5, 5	3	4	5, 5, 5	3, 3, 3	3, 3, 3	4, 4, 4	5	3	3, 3, 3	3, 3, 3	3, 3, 3
Need for sample preparation	1, 2, 3	1, 2, 3	5	4	1, 2, 3	3, 2, 3	4, 2, 3	4, 1	2	3, 4, 1	2, 3, 4	1, 2, 3	1, 2
Lifetime (for Matrix-rich samples)	1, 2, 3	1, 2, 3	5	4	1, 2, 3	3, 2, 3	4, 2, 3	4, 1	2	3, 4, 1	2, 3, 4	1, 2, 3	1, 2
Lifetime (based on particle mechanical stability)	3, 3, 3	3, 3, 3	5	4	4, 4, 2	5, 5, 5	5, 4, 4	4, 4	5	5, 5, 5	5, 5, 5	5, 5, 5	5, 5, 5
100% Aqueous mobile phase compatibility	1, 1, 1	5, 5, 5	1	1	5, 5, 5	1, 1, 1	1, 1, 1	1, 1, 1	1	1, 1, 1	1, 1, 1	1, 1, 1	1, 1, 1
pH stability (range)	3, 3, 3	3, 3, 3	1	2	4, 4, 4	2, 2, 2	2, 2, 2	2, 2, 2	2	1	1, 1, 1	2, 2, 2	2, 2, 2
Bleeding (for MS)	5, 5, 5	5, 5, 5	5	5	4, 4, 4	3, 3, 3	3, 3, 3	5, 5, 5	5	2	2, 2, 3	3, 3, 3	3, 3, 3
Reproducibility (Column-to-Column)	4, 4, 4	4, 4, 4	3	4	4, 4, 5	4, 4, 4	4, 4, 4	4, 4, 4	3	3	3, 3, 3	3, 3, 3	3, 3, 3
Column Back Pressure	1, 2, 3	1, 2, 3	5	4	1, 2, 3	3, 2, 3	4, 2, 3	4, 1	2	3, 4, 2	3, 4, 2	3, 4, 2	3, 4, 2
Useable flow rate ranges	5, 4, 2	5, 4, 2	5	5	5, 3, 2	2, 2, 3	2, 1, 3	2, 1, 5	2	2, 1, 3	2, 1, 3	2, 1, 3	2, 1, 3
Loadability	3, 3, 3	3, 3, 3	4	4	5, 5, 5	5, 5, 5	5, 5, 5	5, 5, 5	5	5, 5, 5	5, 5, 5	5, 5, 5	5, 5, 5
Quantitation - linear response range	4, 4, 4	4, 4, 4	4	5	5, 5, 5	3, 4, 3	4, 3, 3	4, 3, 3	5	3	3, 3, 3	2, 2, 3	2, 2, 3
Sample throughput	5, 5, 4	5, 5, 4	5	5	5, 4, 3	3, 4, 3	2, 4, 3	2, 5	3	3, 2, 4	3, 2, 4	3, 2, 4	3, 2, 4
UHPLC use (Stability at high pressure)	5, 4, 4	5, 4, 4	1	1	5, 5, 2	2, 2, 2	2, 2, 2	2, 2, 5	2	2, 2, 2	2, 2, 2	2, 2, 2	2, 2, 2
Temperature stability	4, 4, 4	4, 4, 4	3	3	5, 5, 5	5, 5, 5	5, 5, 5	5, 5, 5	4	4, 4, 4	5, 5, 5	5, 5, 5	5, 5, 5
Up-Scalability (above 4.6 mm id)	1, 1, 1	1, 1, 1	5	1	1, 1, 4	1, 1, 3	4, 1, 4	5, 1	1	5, 5, 1	4, 5, 1	4, 5, 1	4, 5, 1
Down-Scalability (to below 1 mm id)	1, 5, 1	1, 5, 1	5	3	1, 1, 1	1, 1, 1	1, 1, 1	1, 1, 1	1	1, 1, 1	1, 1, 1	1, 1, 1	1, 1, 1

Criteria - Ranking:

Separation efficiency (N/m)	Temperature (Max °Celsius)
1 = < 50,000	1 = 30
2 = 50,000 - 75,000	2 = 40
3 = 75,001 - 100,000	3 = 50
4 = 100,001 - 150,000	4 = 60
5 = > 150,000	5 = 70

pH stability (range)	UHPLC (Stability at high pressure)
1 = 2-7.5	1 = 200 bar
2 = 2-8	2 = 400 bar
3 = 2-9	3 = 500 bar
4 = 1.5-10.5	4 = 600 bar
5 = 1.5-12	5 = 1000 bar



Validation kits

The success of an HPLC method depends strongly on the consistent quality of the stationary phase. Long-term reproducibility is a key factor in achieving reliable results. Supelco® validation kits consists of three HPLC columns, packed with three different sorbent lots to confirm the reliability of HPLC methods and their robustness.

Selection by USP Classification

HPLC Packings for USP Compendial Methods

The following list describes the main USP classes and the corresponding Supelco® stationary phases. The official pharmaceutical analysis monographs in the United States Pharmacopeia (USP) detail the methods used by pharmaceutical manufacturers for quality control of bulk drug substances and dosage form preparations. Each method specifies a particular high pressure liquid chromatography (HPLC) or gas chromatography (GC) column or column type and the conditions under which the analysis is performed. This table lists the USP Codes for the HPLC phases used in these methods, descriptions of the columns, and information about our products that conform to these descriptions.



Available Columns ^{(2) (3)}					
USP Code ⁽¹⁾	Description ⁽¹⁾	Particles			Monolithic
		Fused-Core® Silica Particles	Fully Porous Silica Particles		Silica Based
		Type B Silica ⁽⁴⁾	Type B Silica ⁽⁴⁾	Type A Silica ⁽⁵⁾	Type B Silica ⁽⁴⁾
L1	Octadecyl silane chemically bonded to porous or non-porous silica or ceramic micro-particles, 1.5 to 10 µm in diameter, or a monolithic rod.	Ascentis® Express C18 BIOshell™ Peptide C18 Ascentis® Express PAH Ascentis® Express PFAS BIOshell™ IgG C18 Ascentis® Express AQ C18	Ascentis® C18 Discovery® C18 Discovery® HS C18 Discovery® BIO Wide Pore C18 Purospher™ RP-18e Purospher™ RP-18 Purospher™ STAR RP-18e Titan™ C18	LiChrosorb® RP-18 LiChrospher® RP-18e LiChrospher® RP-18 LiChrospher® PAH SUPELCOSIL™ LC-18 SUPELCOSIL™ LC-18-DB SUPELCOSIL™ LC-318 SUPELCOSIL™ LC-18-S SUPELCOSIL™ LC-18-T Superspher® RP-18e Superspher® RP-18	Chromolith® CapRod® RP-8e Chromolith® HighResolution RP-8e Chromolith® Performance RP-8e Chromolith® WP 300 RP-18
L3	Porous silica particles, 1.5 to 10 µm in diameter, or a monolithic silica rod.	Ascentis® Express HILIC	Ascentis® Si Purospher™ STAR Si	LiChrosorb® Si 60 LiChrospher® Si 60 SUPELCOSIL™ LC-Si SUPELCOSIL™ LC-3Si Superspher® Si 60	Chromolith® Performance Si Chromolith® Prep Si Chromolith® SemiPrep Si

HPLC Packings for USP Compendial Methods

Available Columns ^{(2) (3)}					
USP Code ⁽¹⁾	Description ⁽¹⁾	Particles			Monolithic
		Fused-Core® Silica Particles	Fully Porous Silica Particles		Silica Based
		Type B Silica ⁽⁴⁾	Type B Silica ⁽⁴⁾	Type A Silica ⁽⁵⁾	Type B Silica ⁽⁴⁾
L7	Octylsilane chemically bonded to totally or superficially porous silica particles, 1.5 to 10 µm in diameter, or a monolithic silica rod.	Ascentis® Express C8	Ascentis® C8 Discovery® C8 Discovery® BIO Wide Pore C8 Purospher™ STAR RP-8e	LiChrosorb® RP-8 LiChrospher® RP-8e 100 LiChrospher® RP-8 100 LiChrospher® RP-Select B 60 SUPELCOSIL™ LC-8 SUPELCOSIL™ LC-8-DB SUPELCOSIL™ LC-308 Superspher® RP-8e 60 Superspher® RP-8 60 Superspher® RP-Select B 60	Chromolith® CapRod® RP-8e Chromolith® HighResolution RP-8e Chromolith® Performance RP-8e Chromolith® WP 300 RP-8
L8	An essentially monomolecular layer of aminopropylsilane chemically bonded to totally porous silica gel support, 1.5 to 10 µm in diameter, or a monolithic silica rod.		Purospher™ STAR NH ₂	LiChrospher® NH ₂ 100 SUPELCOSIL™ LC-NH ₂ SUPELCOSIL™ LC-NH ₂ -NP	Chromolith® NH ₂
L9	Irregular or spherical, totally porous silica gel having a chemically bonded, strongly acidic cation-exchange coating, 3 to 10 µm in diameter.		*TSKgel® SP-2SW	SUPELCOSIL™ LC-SCX	
L10	Nitrile groups chemically bonded to porous silica particles, 1.5 to 10 µm in diameter, or a monolithic silica rod.	Ascentis® Express ES-Cyano BIOshell™ Peptide CN	Ascentis® ES Cyano Discovery® Cyano	LiChrospher® CN SUPELCOSIL™ LC-CN	Chromolith® CN
L11	Phenyl groups chemically bonded to porous silica particles, 1.5 to 10 µm in diameter, or a monolithic silica rod.	Ascentis® Express Phenyl-Hexyl BIOshell™ IgG Diphenyl	Ascentis® Phenyl Purospher™ STAR Phenyl	SUPELCOSIL™ LC-DP SUPELCOSIL™ LC-3DP	
L13	Trimethylsilane chemically bonded to porous silica particles, 3 to 10 µm in diameter.		*TSKgel® TMS-250	SUPELCOSIL™ LC-1	
L14	Silica gel having a chemically bonded strongly basic quaternary ammonium anion-exchange coating, 5 to 10 µm in diameter.		*TSKgel® QAE-2SW	SUPELCOSIL™ SAX1	
L17	Strong cation-exchange resin consisting of sulfonated cross-linked styrene-divinylbenzene copolymer in the hydrogen form, 6 to 12 µm in diameter.			Proteomix® WCX-NP10 SUPELCOGEL™ C-610H SUPELCOGEL™ H	

1st choice for method development

*Tosoh Bioscience columns are available in select countries. For a list, please go to the page 107 of this brochure

1st choice for method development

HPLC Packings for USP Compendial Methods

USP Code (1)	Description (1)	Available Columns (2) (3)			
		Particles			Monolithic
		Fused-Core® Silica Particles	Fully Porous Silica Particles		Silica Based
Type B Silica (4)	Type B Silica (4)	Type A Silica (5)		Type B Silica (4)	
L19	Strong cation-exchange resin consisting of sulfonated cross-linked styrene-divinylbenzene copolymer in the calcium form, 5 to 15 µm in diameter.			Proteomix® SCX-NP5 Proteomix® SCX-NP10 SUPELCOGEL™ Ca	
L20	Dihydroxypropane groups chemically bonded to porous silica or hybrid particles, 1.5 to 10 µm in diameter, or a monolithic silica rod.		TSKgel®* QC-PAK GFC TSKgel®* SuperSW TSKgel®* SW TSKgel®* SW _{XL}	LiChrosorb® Diol LiChrospher® Diol SUPELCO SIL™ LC-Diol	
L21	A rigid, spherical styrene-divinylbenzene copolymer, 3 to 30 µm in diameter.			Hamilton® PRP-1 Hamilton® PRP-3 TSKgel®* SuperH TSKgel®* SuperHZ TSKgel®* H _{HR} TSKgel®* H _{XL}	
L22	A cation-exchange resin made of porous polystyrene gel with sulfonic acid groups, 5 to 15 µm in diameter.			Hamilton® PRP-X200 Hamilton® PRP-X300 SUPELCOGEL™ C-610H SUPELCOGEL™ H	
L25	Packing having the capacity to separate compounds with a molecular weight range from 100 – 5000 (as determined by polyethylene oxide), applied to neutral, anionic, and cationic water-soluble polymers.			TSKgel®* G2500PW _{XL} TSKgel®* G2500PW TSKgel®* G2000PW TSKgel®* G1000PW	
L26	Butyl silane chemically bonded to totally porous or superficially porous silica particles, 1.5 to 10 µm in diameter.	BIOshell™ Protein C4 BIOshell™ IgG C4	SUPELCO SIL™ LC-304		Chromolith® WP 300 RP-4
L27	Porous silica particles, 30 to 50 µm in diameter.		Pelliguard™ LC-Si Supelclean™ LC-Si		
L29	Gamma alumina, reverse-phase, low carbon percentage by weight, alumina-based polybutadiene spherical particles, 5 µm in diameter with a pore volume of 80 Å units.			Aluspher® RP-Select B 100	
L32	A chiral ligand-exchange resin packing-L-proline copper complex covalently bonded to irregularly shaped silica particles, 5 to 10 µm in diameter.	Astec® CLC-D Astec® CLC-L			

1st choice for method development

*Tosoh Bioscience columns are available in select countries. For a list, please go to the page 107 of this brochure

HPLC Packings for USP Compendial Methods (continued)

USP Code (1)	Description (1)	Available Columns (2) (3)			
		Particles			Monolithic
		Fused-Core® Silica Particles	Fully Porous Silica Particles		Silica Based
Type B Silica (4)	Type B Silica (4)	Type A Silica (5)		Type B Silica (4)	
L33	Packing having the capacity to separate dextrans by molecular size over a range of 4,000 to 500,000 Da. It is spherical, silica-based, and processed to provide pH stability.		TSKgel®* G2000SW _{XL} TSKgel®* G4000SW _{XL}		
L34	Strong cation-exchange resin consisting of sulfonated cross-linked styrene-divinylbenzene copolymer in the lead form, 7 to 9 µm in diameter.			SUPELCOGEL™ Pb	
L37	Packing having the capacity to separate proteins by molecular size over a range of 2,000 to 40,000 Da. It is a polymethacrylate gel.			TSKgel®* G3000PW _{XL} TSKgel®* G3000PW	
L38	A methacrylate-based size-exclusion packing for water-soluble samples.			TSKgel®* SuperAW TSKgel®* PW TSKgel®* PW _{XL} TSKgel®* PW _{XL} -CL	
L39	A hydrophilic polyhydroxymethacrylate gel of totally porous spherical resin.			TSKgel®* SuperAW TSKgel®* PW TSKgel®* PW _{XL} TSKgel®* PW _{XL} -CL	
L40	Cellulose tris-3,5-dimethylphenylcarbamate coated porous silica particles, 3 to 20 µm in diameter.		Astec® Cellulose DMP		
L41	Immobilized α1-acid glycoprotein on spherical silica particles, 5 µm in diameter.		CHIRALPAK® AGP		
L43	Pentafluorophenyl groups chemically bonded to silica particles by a propyl spacer, 1.5 to 10 µm in diameter.	Ascentis® Express F5	Discovery® HS F5		
L45	Beta cyclodextrin, R,S-hydroxypropyl ether derivative, bonded to porous silica particles, 3 to 10 µm in diameter.		Astec® CYCLOBOND™ I 2000 Series ChiraDex® ChiraDex® HR		
L49	A reversed-phase packing made by coating a thin layer of polybutadiene on to spherical porous zirconia particles, 3 to 10 µm in diameter.			Discovery® Zr-PBD	

*Tosoh Bioscience columns are available in select countries. For a list, please go to the page 107 of this brochure

1st choice for method development

HPLC Packings for USP Compendial Methods

USP Code (1)	Description (1)	Available Columns (2) (3)			
		Particles			Monolithic
		Fused-Core® Silica Particles	Fully Porous Silica Particles		Silica Based
Type B Silica (4)	Type B Silica (4)	Type A Silica (5)		Type B Silica (4)	
L52	A strong cation exchange resin made of porous silica with sulfopropyl or sulfoethyl groups, 1 to 10 µm in diameter.			SUPELCOSIL™ LC-SCX	
L59	Packing for the size-exclusion separations of proteins (separation by molecular weight) over the range of 5 to 7,000 kDa. The packing is spherical 1.5 to 10 µm, silica or hybrid packing with a hydrophilic coating.		SRT® SEC Series TSKgel®** SuperSW TSKgel®** SW TSKgel®** SW _{XL}		
L60	Spherical, porous silica gel, 10 µm or less in diameter, the surface of which has been covalently modified with alkyl amide groups and endcapped.	Ascentis® Express RP-Amide	Ascentis® RP-Amide Discovery® RP-AmideC16	SUPELCOSIL™ ABZ+Plus SUPELCOSIL™ LC-ABZ	
L62	C30 silane bonded phase on a fully porous spherical silica 3 to 15 µm in diameter.	Ascentis® Express C30			
L63	Glycopeptide teicoplanin linked through multiple covalent bonds to a 100 Å units spherical silica.		Astec® CHIROBIOTIC® T Astec® CHIROBIOTIC® T2 Astec® CHIROBIOTIC® TAG		
L67	Porous vinyl alcohol copolymer with a C18 alkyl group attached to the hydroxyl group of the polymer, 2 to 10 µm in diameter.			apHera™ C18	
L68	Spherical, porous silica, 10 µm or less in diameter, the surface of which has been covalently modified with alkyl amide groups and not endcapped.			SUPLEX™ pKb-100	
L82	Polyamine chemically bonded to cross-linked polyvinyl alcohol polymer, 4 to 5 µm in diameter.			apHera™ NH ₂	
L86	A 5 µm fused core particle with a highly polar ligand possessing 5 hydroxyl groups tethered to the silica gel outer layer.	Ascentis® Express OH5 BIOshell™ Glycan			

1st choice for method development

*Tosoh Bioscience columns are available in select countries. For a list, please go to the page 107 of this brochure

HPLC Packings for USP Compendial Methods (continued)

USP Code (1)	Description (1)	Available Columns (2) (3)			
		Particles			Monolithic
		Fused-Core® Silica Particles	Fully Porous Silica Particles		Silica Based
Type B Silica (4)	Type B Silica (4)	Type A Silica (5)		Type B Silica (4)	
L88	Glycopeptide vancomycin linked through multiple covalent bonds to 100 Ångstroms spherical silica.		Astec® CHIROBIOTIC® V Astec® CHIROBIOTIC® V2		
L95	Highly polar alkyl ligand comprising five hydroxyl groups that are chemically bonded to totally porous or superficially porous silica or a monolithic silica rod.	Ascentis® Express OH5 BIOshell™ Glycan			
L114	Sulfobetaine graft-polymerized to totally or superficially porous silica, 1.5 to 10 µm in diameter, or a monolithic rod. Packing having densely bonded zwitterionic groups with 1:1 charge balance.		SeQuant® ZIC®-HILIC		
L122	ZIC®-pHILIC			ZIC®-pHILIC	

Footnotes:

¹ United States Pharmacopeia. Request from United States Pharmacopeial Convention, Inc., 12601 Twinbrook Parkway, Rockville, MD USA 20852 (tel. 800-227-8772).

² Indicates availability of material(s) matching the description. We are not necessarily the manufacturer of the material.

³ Purple text indicates our recommendation(s).

⁴ Type B silica is obtained from a synthetic source, and is virtually free of metal content.

⁵ Type A silica is obtained from a natural source, so may contain varying degrees of metal content.

*Tosoh Bioscience columns are available in select countries. For a list, please go to the page 107 of this brochure

1st choice for method development

Selection by Column Dimension

Depending on the scale and/or efficiency of the separation required, the table below can help you to choose a column by the most appropriate inner diameter (I.D.) and column length for your needs.

Which column length is best for my needs?

- If you want to maximize the speed of your application20 mm to 75 mm length
- If you want a balance of resolution and speed100 mm
- If you want the best resolution possible150 mm
- Also available in both **analytical** and **semi-prep** dimensions

Column dimension [length x I.D. in mm]	Application	Reason
4 x 4 5 x 2 / 3 / 4.6 10 x 4.6 / 10 / 25	Guard-column	Protection from mechanical contamination Sample contaminated to low extent
25 x 4	Precolumn	High capacity precolumn
30 x 2 / 2.1 / 3 / 4 55 x 2 / 2.1 / 3 / 4 75 x 4	Method development Rapid HPLC and UHPLC (if pressure stable)	Short retention time Rapid equilibration Low solvent consumption (small I.D.) Low pressure drop
100 x 2.1 125 x 2 / 3 150 x 2.1 / 3	High detection sensitivity (mass selectivity)	Semi-micro column for low injection volumes and low peak dispersion Low solvent consumption
100 x 4.6 125 x 4 / 4.6 150 x 4.6	Standard column	Adequate performance for most applications (average performance 8000 – 10000 N/column)
250 x 2 / 2.1 / 3	High detection sensitivity High performance separation	Semi-micro column for low injection volumes and low peak dispersion Low solvent consumption For complex samples
250 x 4.6	High robustness/higher tolerance to injection volume	For very complex samples
250 x 10	Semi-preparative	For mg quantities of pure substance on lab scale
250 x 25	Preparative	For g quantities of pure substance

Guidelines for typical flow rates and orientation values for the loading capacities of analytical and semi-preparative columns

Column dimensions [length x I.D. in mm]	Typical flow rates	Sample amount	Sample volume
150 x 1	0.06 mL/min	≈ 0.05 mg	0.05 – 1 µL
250 x 2	0.25 mL/min	≈ 0.2 mg	0.2 – 5 µL
250 x 3	0.6 mL/min	≈ 1 mg	1 – 20 µL
250 x 4	1 mL/min	≈ 5 mg	5 – 80 µL
250 x 10	6 mL/min	≈ 30 mg	30 – 500 µL
250 x 25	39 mL/min	≈ 200 mg	200 – 3000 µL

Guidelines for Typical flow rates and values for the loading capacities of Nano and capillary columns packed with particles

Capillary column Inner dimension (mm)	Typical flow rate (µL/min)	Sample amount (g)	Sample volume (µL)
1	20 - 200	10 ⁻⁶ – 10 ⁻¹⁰	1
0.5	5 - 50	10 ⁻⁷ – 10 ⁻¹¹	0.25
0.3	2 - 20	10 ⁻⁸ – 10 ⁻¹²	0.128
0.2	1 - 10	10 ⁻⁹ – 10 ⁻¹³	0.057
0.1	0.25 – 2.5	10 ⁻¹⁰ – 10 ⁻¹⁴	0.014
0.075	0.05 – 0.5	<10 ⁻¹³	0.002

Increase sensitivity and save solvents with small I.D. HPLC Columns

The use of smaller inner diameter (I.D.) columns results in decreased solvent usage. Using small I.D. columns less mobile phase is required to achieve the same linear velocity, analysis time can be reduced by increasing flow rate. This allows significant cost and time savings.

In addition, the peak response is increased with small I.D. columns – the peak height increases as the column diameter decreases. The peak response for 2 or 2.1 mm I.D. columns is 3 times higher in comparison to 4.6 mm I.D. columns. This is beneficial when analyzing mass limited samples, typically used in LC-MS applications.

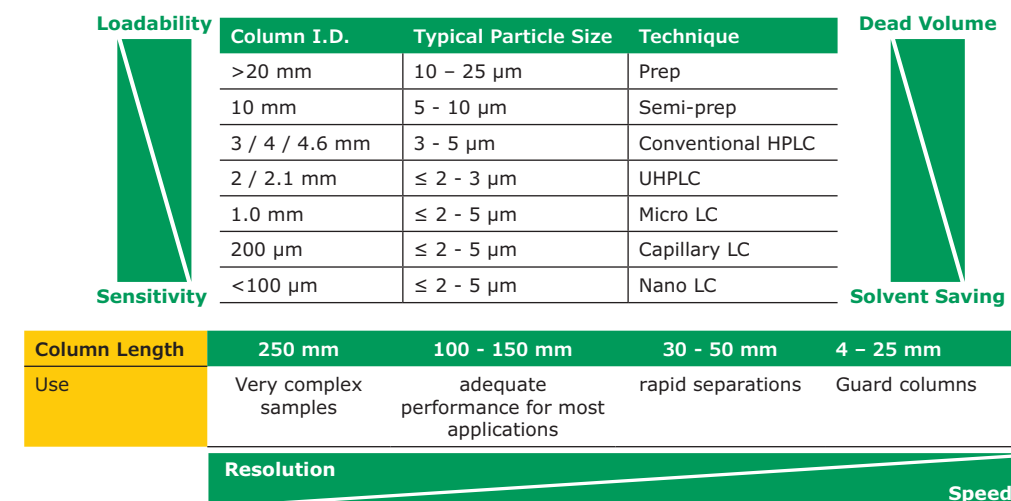

Increase sensitivity and save solvents with 2 mm I.D. Chromolith® RP-18 endcapped columns

Chromolith® Performance RP-18e 100-4.6 mm

Column:	Chromolith® Performance RP-18 endcapped 100-4.6 mm
Mobile phase:	A: 100 % Acetonitrile B: 100 % Water + 0.1 % TFA (v/v) C: 100 % Methanol
Isocratic:	A/B/C 30/60/10 (v/v/v)
Flow rate:	2 mL/min
Pressure:	45 bar (4.5 MPa, 65.3 psi)
Detection:	Dionex Ultimate 3000 VWD-3400, 2.5 Hz, Response time 0.1 s, UV = 210 nm
Vol. detector cell:	11 µL
Temperature:	ambient
Injection volume:	1 µL
Sample:	Bimatoprost Bimatoprost free acid

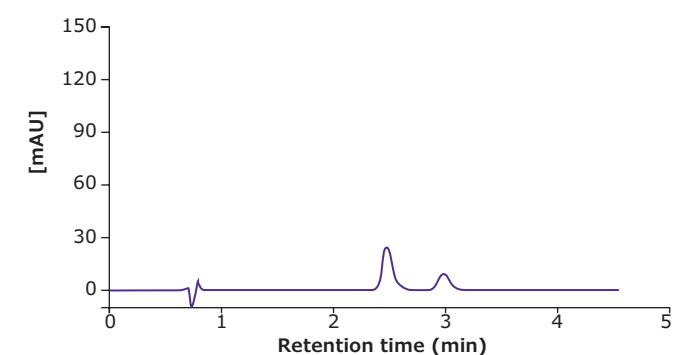

Chromolith® Performance RP-18e 100-2 mm

Column:	Chromolith® Performance RP-18 endcapped 100-2 mm
Mobile phase:	A: 100 % Acetonitrile B: 100 % Water + 0.05 % TFA (v/v) C: 100 % Methanol
Isocratic:	A/B/C 30/60/10 (v/v/v)
Flow rate:	0.38 mL/min
Pressure:	48 bar (4.8 MPa, 70 psi)
Detection:	Dionex Ultimate 3000 VWD-3400, 2.5 Hz, Response time 0.1 s, UV = 210 nm
Vol. detector cell:	1.4 µL
Temperature:	ambient
Injection volume:	1 µL
Sample:	Bimatoprost Bimatoprost free acid

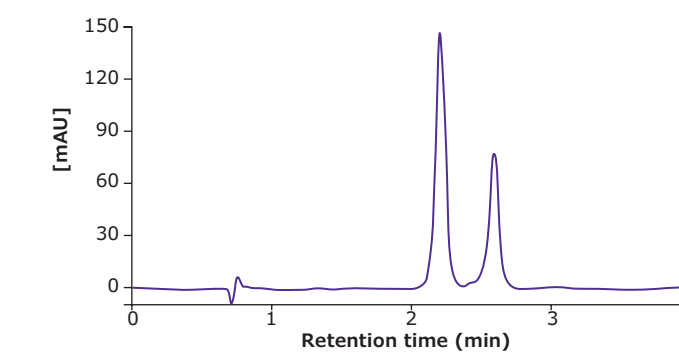

The same separation on a Chromolith® 2 mm I.D. column demonstrates improved sensitivity and solvent savings of 81 %.

HPLC Column Hardware

Supelco® HPLC Columns perfectly fit to every HPLC and U/HPLC instrument. All Supelco® columns have a Parker style endfitting. A 1/16 inch outer diameter capillary connection of stainless steel or PEEK is typically used to connect the HPLC column to the HPLC system. 0.5 mm outer dimension flexible stainless steel capillary connections are suitable as well using a 1/16 inch connection part.

Trademark Hardware	Trademark Sorbent	Column	Use	Precolumn	Material	Pressure stability
LiChoCART®	Purospher™ STAR	HPLC Cartridge	Requires manu-CART® to use	direct integration of precolumn—no separate holder needed	Stainless Steel	250 bar
	LiChrospher®					
	Superspher®					
	LiChrosorb®					
	Aluspher®					
Hibar® RT	Purospher™ STAR	HPLC Column	ready to use column	separate precolumn holder required	Stainless Steel	400 bar
	LiChrospher®					
	Superspher®					
	LiChrosorb®					
Hibar® HR	Purospher™ STAR	UHPLC Column	ready to use column	No precolumns available	Stainless Steel	1000 bar
	SeQuant®	U/HPLC Column	ready to use column	separate precolumn holder required	PEEK lined Stainless Steel	550 bar*
	Chromolith®	U/HPLC Column	ready to use column	separate precolumn holder required	PEEK	200 bar
	Discovery®	HPLC Column	ready to use column	separate precolumn holder required	Stainless Steel	400 bar
	Ascentis®					
	SUPELCO SIL™					
	[LiChrospher®]					
	[LiChrosorb®]					
	Ascentis® Express	HPLC Column	ready to use column	separate precolumn holder required	Stainless Steel	600 bar
	BIOshell™	UHPLC Column	ready to use column	separate precolumn holder required	Stainless Steel	1000 bar
	Ascentis® Express (2 µm)					
	BIOshell™ (2 µm)					
	Titan™					

*SeQuant® ZIC®-pHILIC: 200 bar

Supelco® HPLC, UHPLC and Capillary columns are available in different column hardware designs:

Ascentis® Express and BIOshell™ as well as SUPELCO SIL™, Discovery®, Ascentis®, Titan™ and Astec® columns are designed for direct connection to any HPLC system. Supelguard™ pre-columns protect the analytical HPLC column.

SeQuant® PEEK lined stainless steel ready to use U/HPLC and capillary columns

SeQuant® columns are PEEK lined stainless steel columns making them best suitable for HILIC separations including phosphorylated compounds and meeting the need for bioinertness



Chromolith® PEEK columns

Chromolith® monolithic silica HPLC columns are clad in inert PEEK (polyetheretherketone) polymeric material and can be connected directly to HPLC or UHPLC system as a “ready to use” column.



Hibar® HR ready to use UHPLC columns

Purospher™ STAR Hibar® HR UHPLC columns are fully compatible with any UHPLC instrument and provide a pressure stability of 1000 bar.



Hibar® RT ready to use HPLC columns

Hibar® RT HPLC columns are made of stainless steel providing a pressure stability of 400 bar. For the use of a pre-column, a separate pre-column holder is required.



LiChroCART® HPLC cartridge

With LiChroCART® cartridges, the user works with re-usable manu-CART® endfittings which fit different cartridge lengths and inner dimensions. Since these cartridge holders may remain in the system, and the capillary connections do not need to be detached, the cartridges may be changed within the shortest possible time.



manu-CART® holder for LiChroCART® HPLC cartridges

The “one-turn” cartridge system for simple, rapid hand tight fitting of cartridges and pre-columns. manu-CART® cartridge holder for the LiChroCART® cartridge system are reusable and it allows for every cartridge length with different internal diameter a simple turn permits an easy and problem-free integration of a guard cartridge. For coupling of two LiChroCART® cartridges, a coupling unit can be used and for connecting a LiChroCART® HPLC cartridge with a LiChroCART® 25-4 pre-cartridge the coupling kit. The manu-CART® cartridge holder is for 2, 3, 4 and 4.6 mm I.D. LiChroCART® cartridges and 75, 100, 125, 150 and 250 mm length.

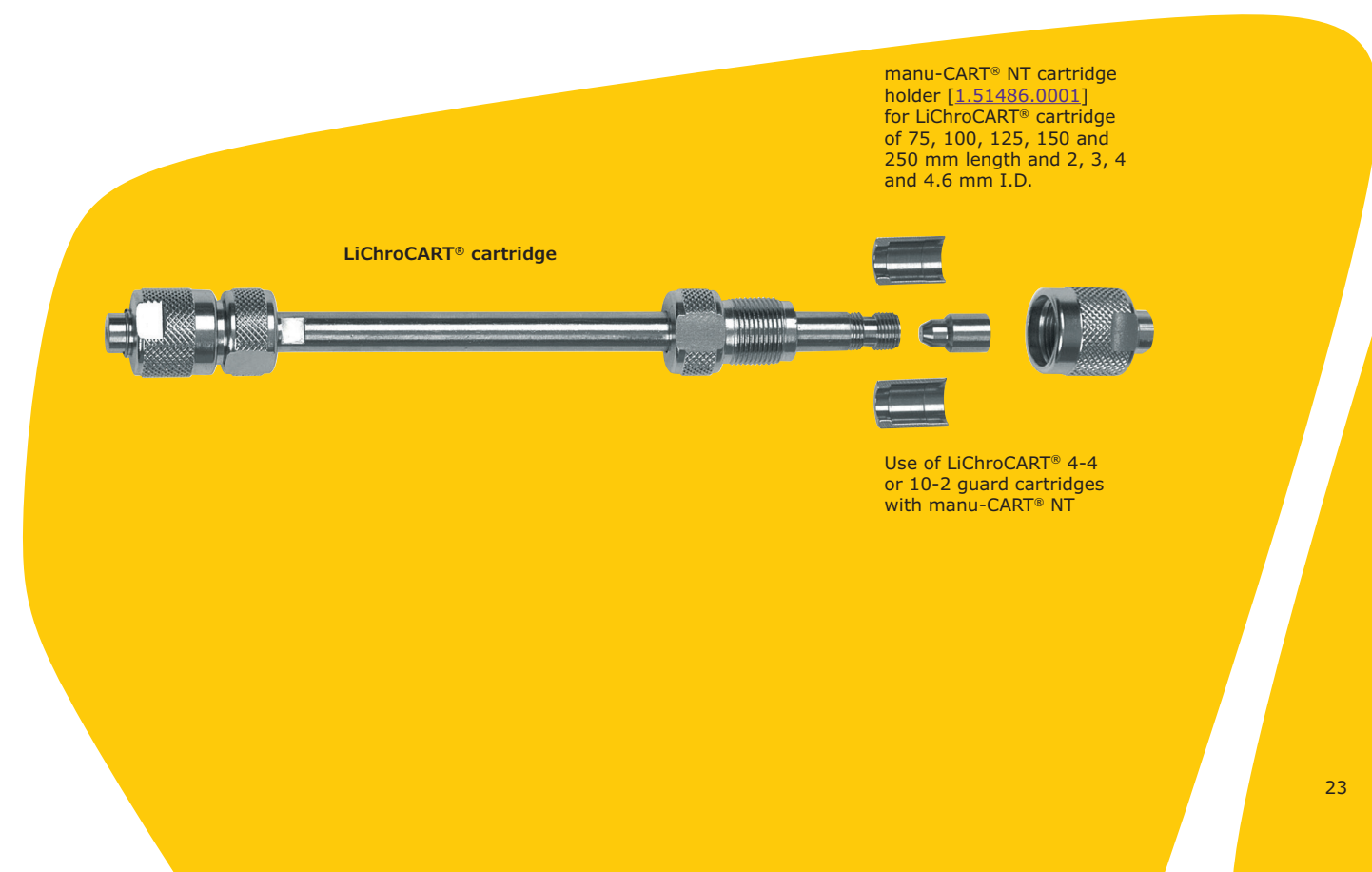

LiChroCART® cartridge

manu-CART® NT cartridge holder [1.51486.0001] for LiChroCART® cartridge of 75, 100, 125, 150 and 250 mm length and 2, 3, 4 and 4.6 mm I.D.

Use of LiChroCART® 4-4 or 10-2 guard cartridges with manu-CART® NT

Column Accessories and Pre-column Holder

Supelco® HPLC Columns perfectly fit to every HPLC and U/HPLC instrument. All Supelco® columns have a Parker style endfitting. A 1/16 inch outer diameter capillary connection of stainless steel or PEEK is typically used to connect the HPLC column to the HPLC system. 0.5 mm outer dimension flexible stainless steel capillary connections are suitable as well using a 1/16 inch connection part. For protection of the analytical HPLC column from contamination it is recommended to use guard- or pre-columns. These short columns are placed typically into a guard column holder. For the different column hardwares described on the previous pages, corresponding pre-column holders are available.

Supelguard™

Product	Ordering No.	Contents of one package
59660-U	Stand-Alone, for use with Supelguard™ cartridges (2 cm L x 2.1 to 4.6 mm I.D.)	pkg of 1 ea fittings included
21150AST	Stand-Alone (Swivel-type), for use with Supelguard™ cartridges (2 cm L x 2 to 4.6 mm I.D.)	Holder fits 2cm x 2, 3, and 4 mm I.D. Astec® CYCLOBOND™, CHIROBIOTIC®, Cellulose DMP, guard cartridges. Cartridges, tubing, nuts and ferrules are not included
55205	Direct-Connect (Swivel-type), for use with Supelguard™ cartridges (2 cm L x 3 to 4.6 mm I.D.)	Connects guard column directly to a 3.0, 4.0 and 4.6 mm I.D. Supelco® analytical column
504254	Direct-Connect (Swivel-type), for use with Supelguard™ cartridges (2 cm L x 3 to 4.0 mm I.D.)	Directly connects a 2 cm Supelguard™ cartridge to a Supelco® analytical cartridge after the column end-fitting is removed
504262	Direct-Connect (Swivel-type), for use with Supelguard™ cartridges (2 cm L x 2.1 mm I.D.)	For direct connection to 2.1 mm I.D. Supelco® columns
581392-U	Stand-Alone, for use with Supelguard™ cartridges (1 cm L x 21.2 mm I.D.)	For use with Supelguard™ cartridges (1 cm L x 21.2 mm I.D.)



21150AST



504254



581392-U

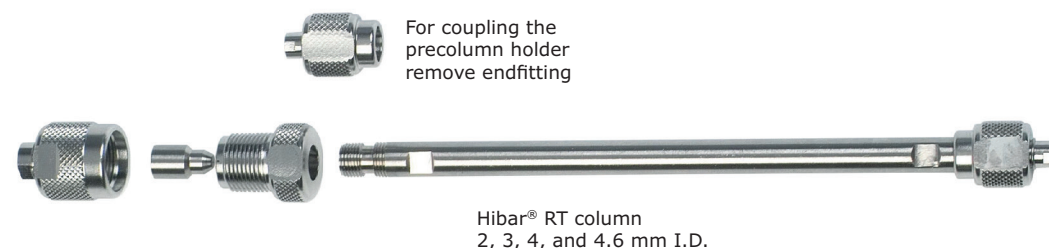

Ordering information

Guard column holder for Hibar® RT columns

Product	Ordering No.	Contents of one package [see figure on next 2 pages]
Precolumn holder for 4-4 LiChroCART® cartridges for capillary connection to Hibar® RT column	1.16217.0001	1 piece
Precolumn holder for 4-4 LiChroCART® cartridges for direct coupling to Hibar® RT column	1.51487.0001	1 piece

Ordering information

manu-CART® cartridge holder, manu-CART® endfittings for stainless steel cartridges LiChroCART®

Product	Ordering No.	Contents of one package
manu-CART® NT cartridge holder for 2, 3, 4 and 4.6 mm I.D. LiChroCART® cartridges	1.51486.0001	2 complete stainless steel units for mounting one LiChroCART® cartridge
manu-CART® "10" II cartridge holder for 10 mm I.D. LiChroCART® cartridges	1.51419.0001	2 complete stainless steel units for mounting one LiChroCART® cartridge
manu-CART® coupling kit for coupling with LiChroCART® 25-4 pre-cartridge	1.50082.0001	1 coupling unit 1 endfitting for LiChroCART® 25-4
manu-CART® coupling unit to connect two LiChroCART® cartridges	1.50083.0001	1 piece
manu-CART® holder 25-4 and 25-2	1.50017.0001	1 piece
manu-CART® holder 30 mm for 30-2, 30-3 and 30-4 LiChroCART® cartridges	1.50227.0001	1 piece
manu-CART® holder 55 mm for 55-2, 55-3 and 55-4 LiChroCART® cartridges	1.50226.0001	1 piece
Pressure cone for manu-CART® endfitting	1.51258.0001	2 pieces
Split collets for manu-CART® endfitting	1.51257.0001	4 pieces

manu-CART® holder 30 mm [1.50227]
for LiChroCART® 30-4, 30-3 and 30-2



manu-CART® holder 55 mm [1.50226]
for LiChroCART® 55-4, 55-3 and 55-2



manu-CART® cartridge holder



Mounting with guard cartridge 4-4 or 10-10

- Slide sleeve over cartridge.
- Fix split-collets in the groove in direction of the guard cartridge. Apply guard cartridge with its cone in direction of the main cartridge, slide sleeve on top and fasten with cap nut.

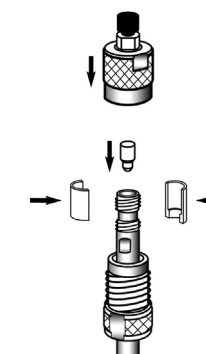

Mounting without guard cartridge

- Slide sleeve with external thread over cartridge.
- Using your finger, hold one split-collet at the groove. Apply the second split-collet, slide sleeve over it and fasten with cap nut.

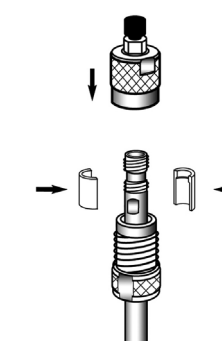

Fused-Core® (Superficially Porous Silica Particles, SPP) HPLC and UHPLC columns

Maximum Resolution for Small and Large Molecule Separation

Ascentis® Express and BIOshell™ HPLC and UHPLC columns are based on Fused-Core® particle technology enabling fast results with highest resolution.

Fused-Core® columns feature narrower particle size distribution as well as a shorter diffusion path compared to fully Porous Particles. The result is increased resolution, added sensitivity and higher throughput.

Fused-Core® particles consist of a solid silica core and a porous silica shell allowing a shorter diffusion path compared to conventional fully Porous Particles.

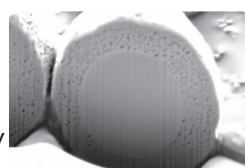

Features of Fused-Core® particles over Fully Porous Particles:

- Narrower particle size distribution
- More consistently packed bed
- Shorter diffusion path

Superior for small molecule separation:

Ascentis® Express HPLC and UHPLC columns

Ascentis® Express HPLC and UHPLC columns provide about 40% more efficiency in comparison to columns with fully Porous Particles of the same size. This performance enhancement is applicable to all HPLC instruments (in addition to UHPLC systems).

The very broad range of column chemistries makes it easy to select the best suitable column for any HPLC and UHPLC application – from Capillary column dimensions to analytical 4.6 mm I.D. dimensions.

As well as for biomolecule separation:

BIOshell™ UHPLC and HPLC Columns

BIOshell™ UHPLC and HPLC columns deliver maximum speed and efficiency for the separation of biomolecules on both UHPLC and HPLC systems. The Fused-Core® superficially porous silica particles (SPP) with pore sizes from 90 Å up to 1000 Å allow superior separation of glycans as well as very large proteins. In particular, a pore size of 1000 Å shows very clear advantages over common 300 Å pores for the separation of very large proteins in biotherapeutic drug development such as monoclonal antibodies (mAbs) or proteins with molecular weights greater than 100 kDa.

Fused-Core® Particles (SPP)

Fused-Core® (Superficially Porous Particles, SPP)

Fully Porous Particles (FPP)

Narrow Particle Size Distribution

More Consistent Bed

Shorter Diffusion Path

The innovative manufacturing process for Fused-Core® particles produces a very narrow particle size distribution. This allows for the use of larger porosity frits that clog less, resulting in a more rugged column. Traditional fully porous particles provide a larger particle size distribution, requiring smaller pore frits that clog more easily.

The "A" term in the van Deemter equation accounts for the effects of heterogeneities in the packed bed of an HPLC column. Narrow particle size distributions form a more consistently packed bed and more consistent path lengths, minimizing analyte dispersion (peak broadening) through the column. This eddy diffusion is effectively independent of mobile phase velocity.

The short diffusion path of the Fused-Core® particle yields sharper peaks than on traditional fully porous particle columns. The minimized resistance to mass transfer, the "C" term in the van Deemter equation, of the Fused-Core® particle provides sharper peaks than traditional fully porous particles. The short diffusion path also permits the use of higher flow rates without significant peak broadening / loss in efficiency.

The factors that affect chromatographic efficiency are eddy diffusion, longitudinal diffusion, and resistance to mass transfer, the A, B and C terms respectively from the van Deemter equation.

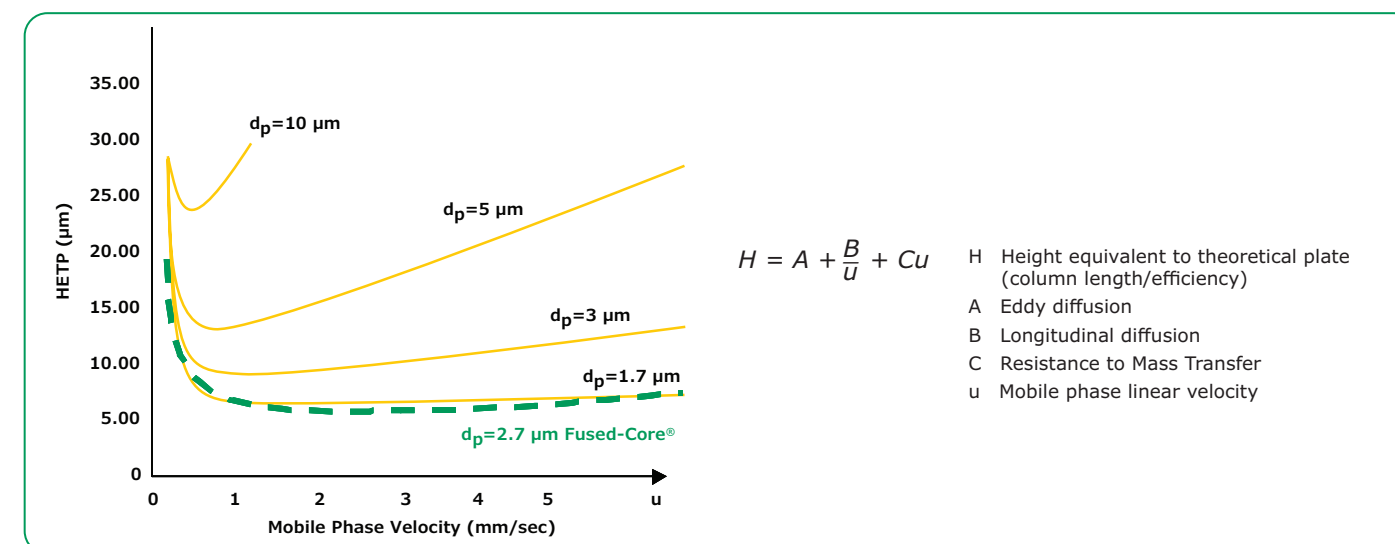

Ascentis® Express HPLC and UHPLC columns

Maximum Resolution on any System

Based on **Fused-Core® particle technology**, Ascentis® Express columns provide an exceptional advancement in HPLC column performance and the benefits of high sample throughput at maximum resolution.

Feature and benefits:

- Fused-Core® technology (Superficially Porous Particles; SPP)
- Maximum speed and efficiency on both UHPLC and HPLC systems (particle sizes: 2 µm, 2.7 µm and 5 µm)
- 40% more efficiency in comparison to Fully Porous Particles (FPP) of same particle size
- UHPLC columns with 2 µm particles (pressure stable 1000 bar)
- Column dimensions from 0.075 mm I.D. (capillary columns) to 4.6 mm I.D. (analytical HPLC columns)
- Broadest range of phases/selectivities for optimal method development

Twice the Speed at Equivalent Pressure vs. sub-2 µm Fully Porous Particles

Compared to fully porous sub-2 µm particles typically used in UHPLC, Ascentis® Express Fused-Core® 2.7 µm particles generate approximately half the backpressure while providing the same high resolution. This trait permits both longer columns, for more resolving power, and faster flow rates, for higher throughput. Demonstrating this point, the separation below shows a steroid mixture on Ascentis® Express (top) and a sub-2 µm UHPLC column (bottom) of the same dimensions. Due to the lower backpressure of the Ascentis® Express, an increased flow rate (double in this case) can be applied, providing the same back pressure, separation efficiency and resolution as on a sub-2 µm UHPLC column, just with a 50% shorter runtime, increasing sample throughput.

Chromatographic conditions:

Columns:	Ascentis® Express C18, 10 cm x 2.1 mm I.D., 2.7 µm particles (53823-U) and sub-2 µm particle column (same dimensions)
Mobile phase:	water/acetonitrile 49:51 (for Ascentis® Express); water/acetonitrile 55:45 (for sub-2 µm)
Column temp:	ambient
Detector:	UV, 200 nm
Injection:	1 µL

Ascentis® Express C18
0.4 mL/min flow rate

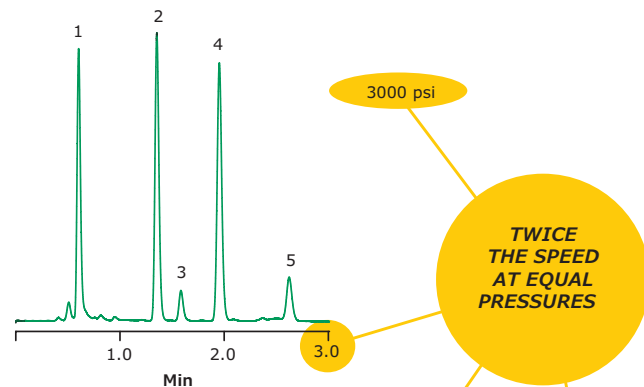

Sub-2 µm competitor
0.2 mL/min flow rate

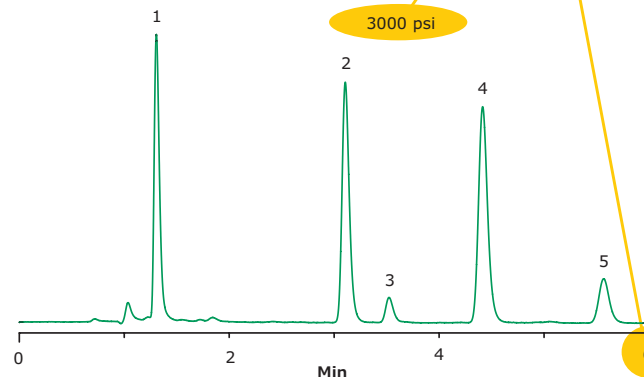

1. Estradiol
2. β-Estradiol
3. Impurity
4. Estrone
5. Estrone degradant

Best fit for HPLC and UHPLC

Best Fused-Core® UHPLC column

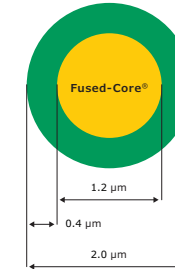

An optimized solution for high throughput small molecule analysis

Pressure stability: 2 µm: 1000 bar

Fast HPLC on any System

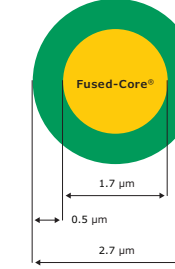

A practical solution that delivers UHPLC performance from any HPLC

2.7 µm: 600 bar

The Lab Work-horse Column

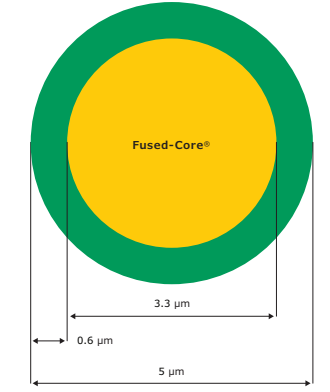

True plug and play solution for improving separations on existing 3 µm or 5 µm fully porous particle HPLC columns

5 µm: 600 bar

More separation power per unit pressure

Designed to deliver speed and resolution on all UHPLC and HPLC systems, Ascentis® Express columns with Fused-Core® technology exceed the benefits of sub-2, 3 and 5 µm particles. Ascentis® Express 2.7 µm particles deliver more resolving power per unit pressure than even sub-2 µm particles on any HPLC system (including UHPLC). Ascentis® Express 5 µm columns are able to achieve greater speed and efficiency than any other 5 µm particle-based column. This fact means that Ascentis® Express 5 µm columns can be the standard column for all fully porous 5 µm-based methods. With the addition of 2.0 µm Ascentis® Express UHPLC columns, we now offer three U/HPLC Fused-Core® particle sizes, making the Ascentis® Express column line truly scalable from HPLC to UHPLC.

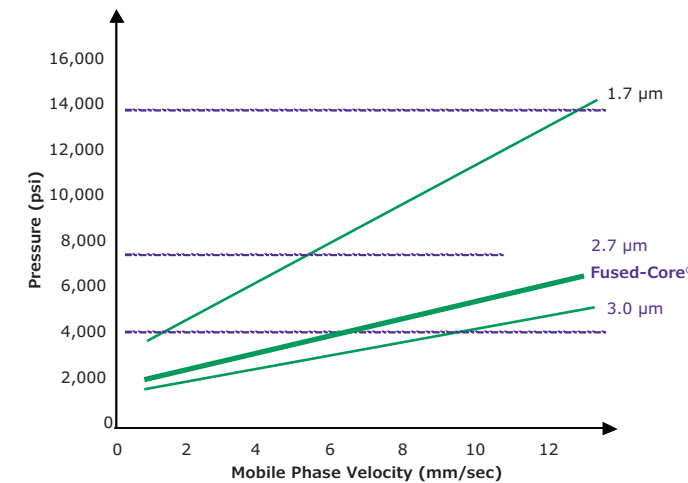

Higher Sample Throughput Without Compromises

The outstanding separating power of Ascentis® Express HPLC columns allows the use of shorter column dimensions while maintaining good resolution. This trait results in higher sample throughput and reduction in costs.

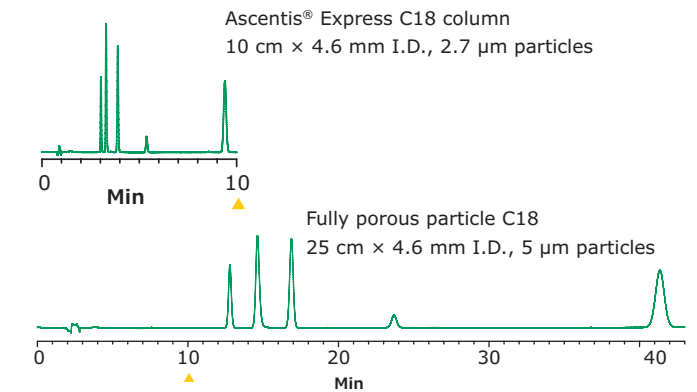

A Broad Range of Column Selectivities for all Compound Classes

Column selectivity has the highest influence on resolution in chromatography. Selection of the best column chemistry for your target analytes is therefore an important selection parameter. C18 column chemistries are typically the first choice. Nevertheless, when a C18 does not give the desired separation or the sample contains compounds that are known to be difficult to retain or resolve on a C18, consider changing stationary phase chemistry early in method development for more optimal applications. The range of selectivity provided by Ascentis® Express makes this easy.

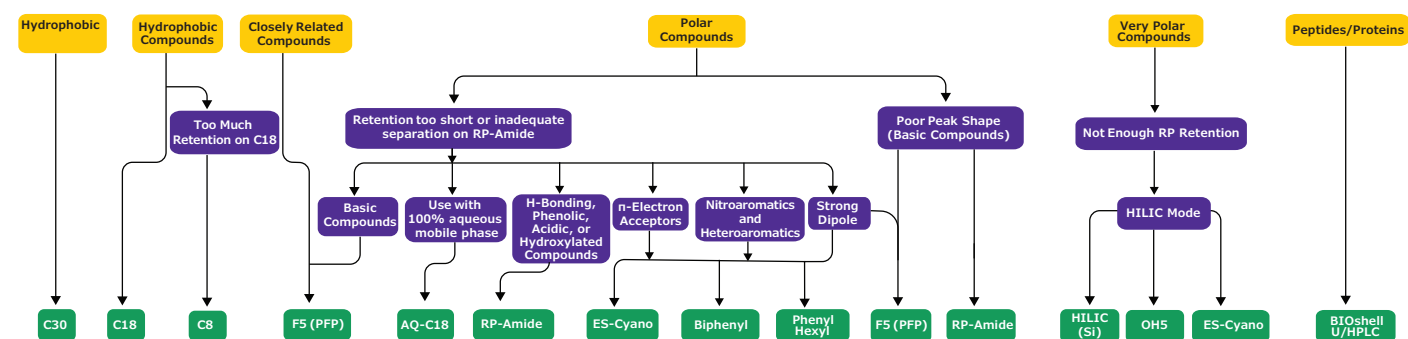

Excellent Lot-to-Lot Reproducibility

The consistency of chromatographic results depends on many factors. One major contributor to consistent and reliable results is the HPLC column. Therefore, the lot-to-lot and column-to-column reproducibility is a major concern. Ascentis® Express HPLC and UHPLC columns show excellent reproducibility. Over the last 10 years, the relative standard deviation (RSD) of the QA retention factor was 1.2%.

Visit: SigmaAldrich.com/express

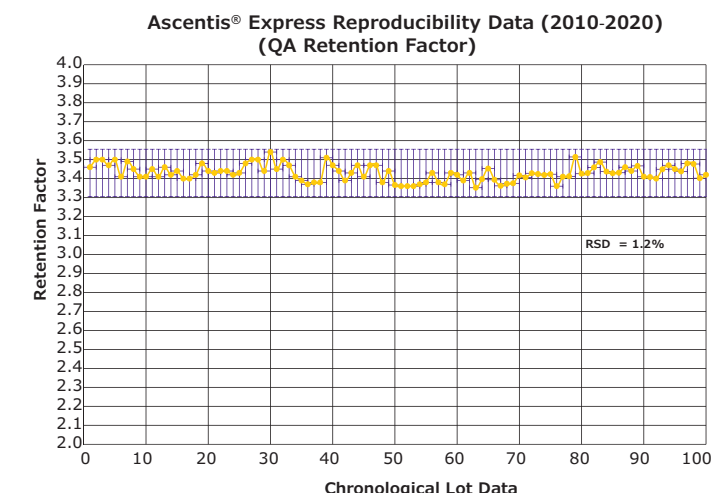

Ascentis® Express	Phase Bonding	USP Designation	Bonding Chemistry	Chromatographic Properties / Use	Particle Size (µm)	Pore Size (Å)	Surface Area (m ² /g)	Carbon Load (%)	Surface Coverage (µmol/m ²)	Low pH Limit/ Max T	High pH Limit/ Max T	Encapped
	C18	L1	Dimethyloctadecyl	Outstanding performance for a broad range of analytes. Excellent peak shape for acids, bases and neutral compounds.	2	90	120	7.2	3.6	2/60 °C	9/40 °C	Yes
					2.7		135		3.4			
					5		90		4			
	AQ-C18	L1	Polar modified Octadecyl	Resistant to dewetting; compatible with 100% aqueous mobile phase. Suitable for the separation of polar compounds in RP-mode.	2	90	120	6.5	3.1	2/60 °C	9/40 °C	Yes
					2.7		135		3.2			
					5		90		3.6			
	Peptide ES-C18	L1	Diisobutyloctadecyl	Fast separation of peptides and polypeptides with high peak capacity. Ideal for pharmaceutical/therapeutic peptide separation, peptide mapping, natural and synthetic peptide analysis and oligonucleotide analysis.	2.7	160	90	4.6	2.1	1/90 °C	8/40 °C	No
	C30	L62	Triacetyldimethyl	Excellent selectivity for hydrophobic, long chain and structurally related isomers.	2.7	160	90	4.5	1.4	2/60 °C	9/40 °C	Yes
	C8	L7	Dimethyloctyl	Enhanced retention for less hydrophobic compounds or faster separation if retention on C18 is too high	2	90	120	4.8	3.6	2/60 °C	9/40 °C	Yes
					2.7		135		3.6			
					5		90		3.6			
	Phenyl-Hexyl	L11	Dimethylphenyl-hexyl	Enhanced selectivity for aromatic compounds; strong pi-pi donor. Ideal for the separation of ketones, nitriles and alkenes.	2	90	120	6.3	3.4	2/60 °C	9/40 °C	Yes
					2.7		135		3.5			
					5		90		3.7			
	Biphenyl	L11	Dimethylbiphenyl	High selectivity for aromatic compounds with enhanced pi-pi and mild steric interactions due to the two sequential phenyl groups. Ideal for rapid, efficient drug and metabolite analysis using conditions that are compatible with MS detection.	2	90	120	6.7	3.6	2/60 °C	9/40 °C	Yes
					2.7		135		3.4			
					5		90		3.9			
	F5 (PFP)	L43	Pentafluorophenylpropyl	Outstanding selectivity for stereoisomers, strong pi-pi acceptor. Enhanced selectivity for aromatic and electron-rich compounds. Can be used in Reversed-phase and HILIC mode. In comparison with the C18 phases, the F5 phase shows longer retention time of basic analytes and less retention of hydrophobic analytes.	2	90	120	5.3	3.8	2/60 °C	8/40 °C	Yes
					2.7		135		3.5			
					5		90		3.6			
	ES-Cyano	L10	Diisopropylcyanopropyl	Enhanced retention for polar compounds and much less retention for hydrophobic compounds. Ideal for the separation of non-polar bases in HILIC mode (Ion-exchange mechanism). Compatible to 100% aqueous mobile phase and stable at low pH and high temperature.	2	90	120	3.4	2.5	1/80 °C	8/40 °C	Yes
					2.7		135		2.3			
					5		90		2.4			
	RP-Amide	L60	C16-Amide	Complementary selectivity to alkyl phases with improved peak shape for basic compounds compared to older EPG amide phases. Ideal for the separation of organic acids, phenols, catechins, alcohols, and bases. Compatible in 100% aqueous mobile phase.	2	90	120	7.3	3	2/60 °C	9/40 °C	Yes
					2.7		135		3			
					5		90		3			
	HILIC	L3	Bare silica	Enhanced separation of polar compounds. Can be used in HILIC and normal-phase mode. Offers both ion-exchange and partition mechanisms of separation in HILIC mode.	2	90	120	Unbonded	Unbonded	1/60 °C	8/40 °C	N.A.
					2.7		135					
					5		90					
	OH5	L95	Penta-hydroxy	Ideal for the HILIC separation of very polar compounds with a LogP value close to 0 or less than 0. Exhibits predominantly HILIC partitioning retention, limited silanol anionic character, and is relatively insensitive to ionic strength.	2	90	120	2.8	3	2/60 °C	9/40 °C	No
					2.7		135		3			
					5		90		3			

Ascentis® Express UHPLC Columns

Ascentis® Express columns with 2 µm particles are dedicated UHPLC columns which deliver reliable high speed and high resolution separations at pressures lower than fully porous sub-2 µm columns.

- Highest UHPLC performance possible without the ultra-high pressure of sub-2 µm fully porous columns
- Highest efficiency and best performance obtained with UHPLC instruments
- Excellent for fast method development due to full range of column chemistries
- 1 µm inlet frit enable high ruggedness
- Pressure stability: 1000 bar/14,500 psi

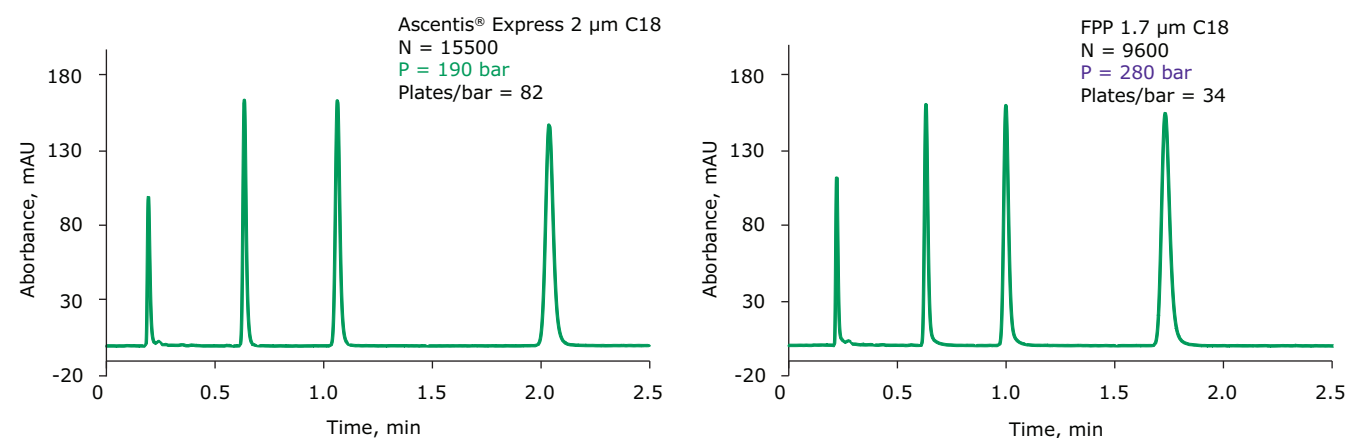
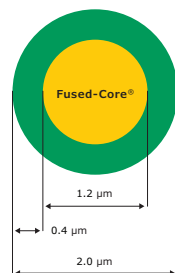

Chromatographic Conditions:

Dimensions of both Columns:	2.1 x 50 mm	Flow rate:	0.5 mL/min
Mobile Phase A:	A: water B: acetonitrile	Injection Volume:	0.2 µL
Isocratic:	A/B: 15/85	Detection:	254 nm
		Temperature:	25 °C

Peak Identities:

1. Uracil
2. Pyrene
3. Decanophenone
4. Dodecanophenone

Ascentis® Express 2 µm UHPLC Columns enable full suitability in UHPLC applications providing very high efficiencies at lower column backpressure in comparison to 1.7 µm fully Porous Particles (FPP)

UHPLC Analysis of Methotrexate and Related Compounds on Ascentis® Express C18, 2.0 µm

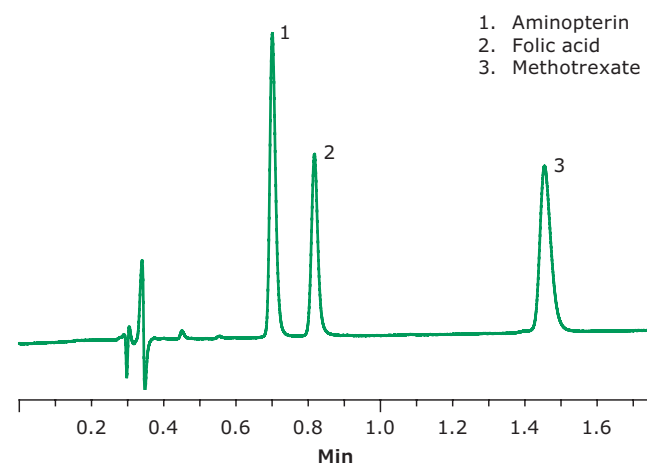

Column:	Ascentis® Express C18, 10 cm x 2.1 mm I.D., 2.0 µm particles (50813-U)
Column temp.:	35 °C
Mobile phase:	[A] 10 mM ammonium formate, pH 3.0 with formic acid; [B] acetonitrile; (90:10, A:B)
Flow rate:	0.7 mL/min
Pressure:	1153 psi (795 bar)
Sample:	50 µg/mL in 85:15, water:methanol
Injection:	1 µL
Detector:	UV, 254 nm

High resolution UHPLC Analysis of Cannabinoids on Ascentis® Express C18, 2.0 µm

With increasing cannabis and hemp legislation, there has been increased demand for development and validation of accurate and precise testing methods for potency quantitation. Ascentis® Express 2 µm UHPLC columns enable the high resolution separation of 17 Cannabinoids in 6 minutes.

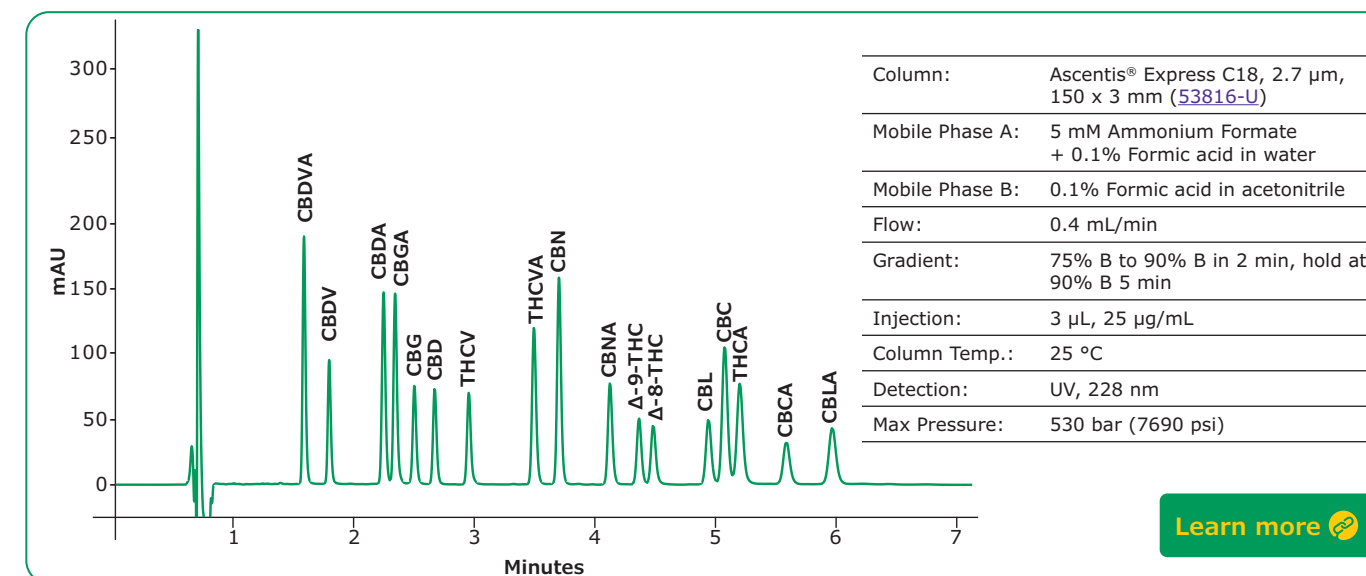

[Learn more](#)

UHPLC Separation of Explosives on Ascentis® Express C18 2 µm UHPLC Column compared to FPP C18 UHPLC Column

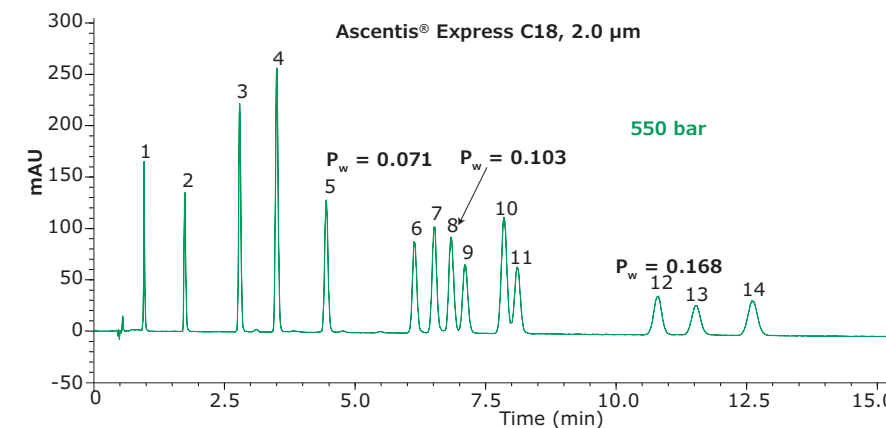

Chromatographic Conditions:

Dimensions of both Columns:	100 mm x 2.1 mm ID
Mobile Phase:	A: Water B: Methanol
Isocratic:	A/B: 72/28
Flow rate:	0.4 mL/min
Detection:	PDA @ 254 nm
Temperature:	42 °C

Peak Identities:

1. Peak Identities:
2. HMX
3. RDX
4. 1,3,5-Trinitrobenzene
5. 1,3-Dinitrobenzene
6. Nitrobenzene
7. Tetryl
8. 2,4,6-Trinitrotoluene
9. 2-Amino-4,6-Dinitrotoluene
10. 4-amino-2,6-dinitrotoluene
11. 2,4-Dinitrotoluene
12. 2,6-Dinitrotoluene
13. 2-Nitrotoluene
14. 4-Nitrotoluene
15. 3-Nitrotoluene

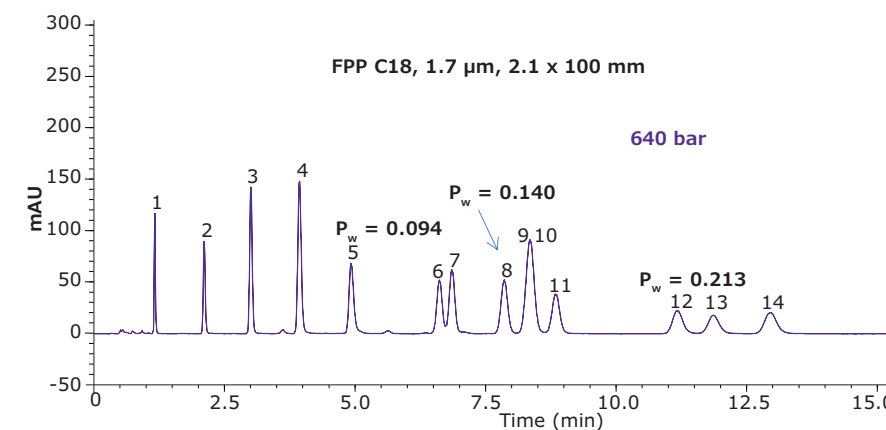

Ascentis® Express UHPLC columns

Ascentis® Express columns for environmental testing

Ascentis® Express PAH HPLC columns delivers a fast and high efficiency separation of 16 standard PAH compounds with a resolution value of at least 1.5 in under five minutes for EPA 8310 and EPA 610.

- Application-assured through method qualified lot analysis
- 2.7 µm Fused-Core® particle for UHPLC-like separation with maximum resolution at lower back-pressure in comparison to sub-2 µm particles
- Well suited for UV, fluorescence and MS detection

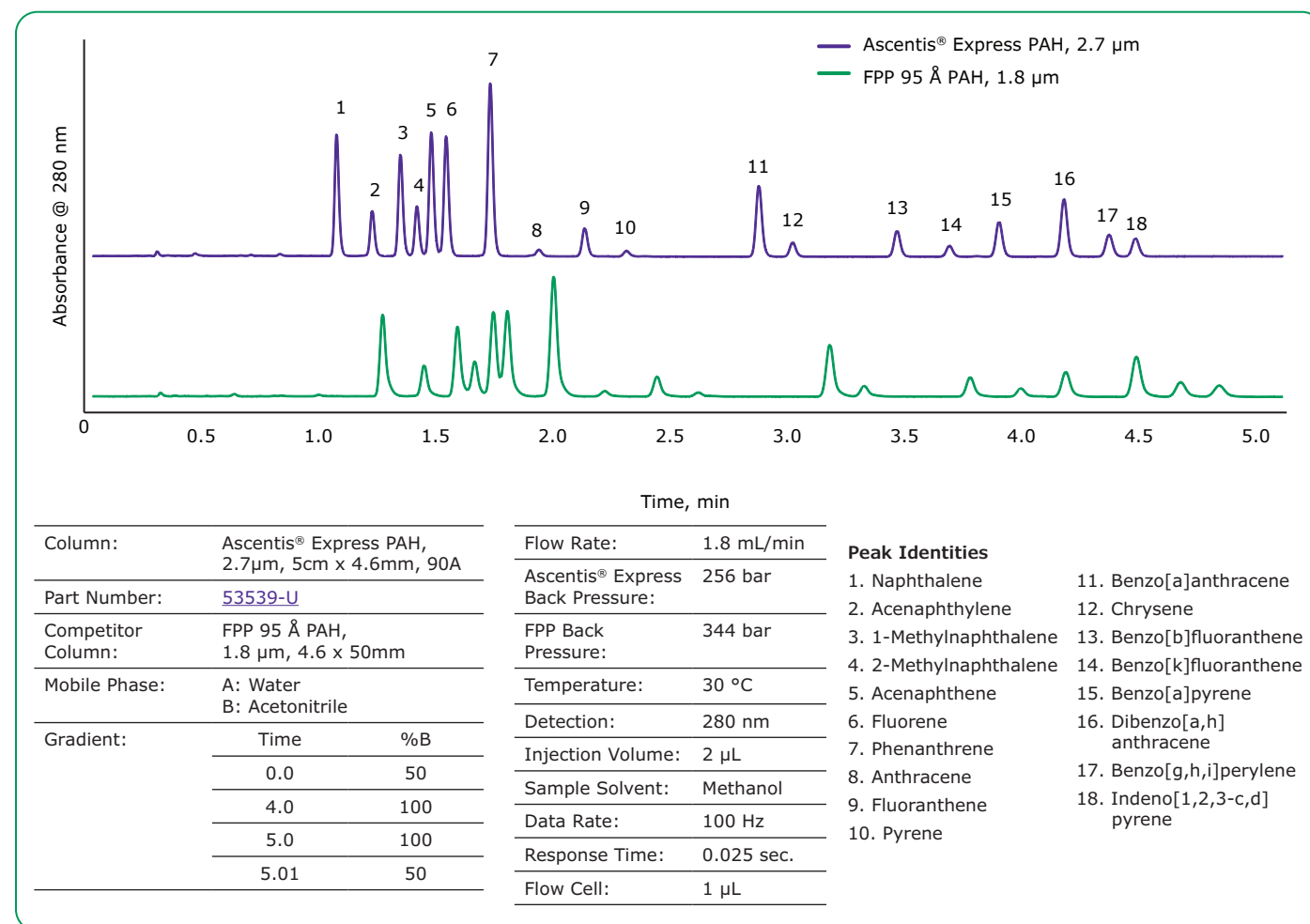

Ascentis® Express PFAS HPLC Columns and Delay Columns

The new Ascentis® Express PFAS HPLC column is designed for the separation of novel and legacy short chain and long chain PFAS compounds containing branched and linear isomers, whilst adhering to EPA methodology requirements. Furthermore, a specific PFAS delay column prevents background PFAS contamination from interfering with the sample results in quantitative LC-MS methods. The Ascentis® Express PFAS HPLC column, with its Fused-Core® technology and a particle size of 2.7 µm, delivers fast and high-resolution separations with excellent selectivity, peak shape, and necessary retention to perform in EPA methods 537.1, 533 and 8327. These advantages are demonstrated, in one particular example, by the separation of all PFAS analytes from EPA methods 537.1, 533, and 8327 in under five minutes.

- Application-assured through method qualified lot analysis
- 2.7 µm Fused-Core® particle for UHPLC-like separation with maximum resolution at lower back-pressure in comparison to sub-2 µm particles
- Endcapped alkyl phases for high sensitivity (no bleed) LC-MS analysis

PFAS Testing

Ascentis® Express PFAS HPLC Columns and Delay Columns

Ascentis® Express PFAS column Delay is a high-performance liquid chromatography column based on Fused-Core® particle design. The highly retentive, endcapped silane of the Ascentis® Express PFAS Delay column provides high retention of PFAS compounds across various mobile phase conditions and is used to delay background instrument PFAS contamination from interference with analyzed samples. For this reason, the Ascentis® Express PFAS Delay column is placed upstream of the sample injector and after the mixer. See diagram below.

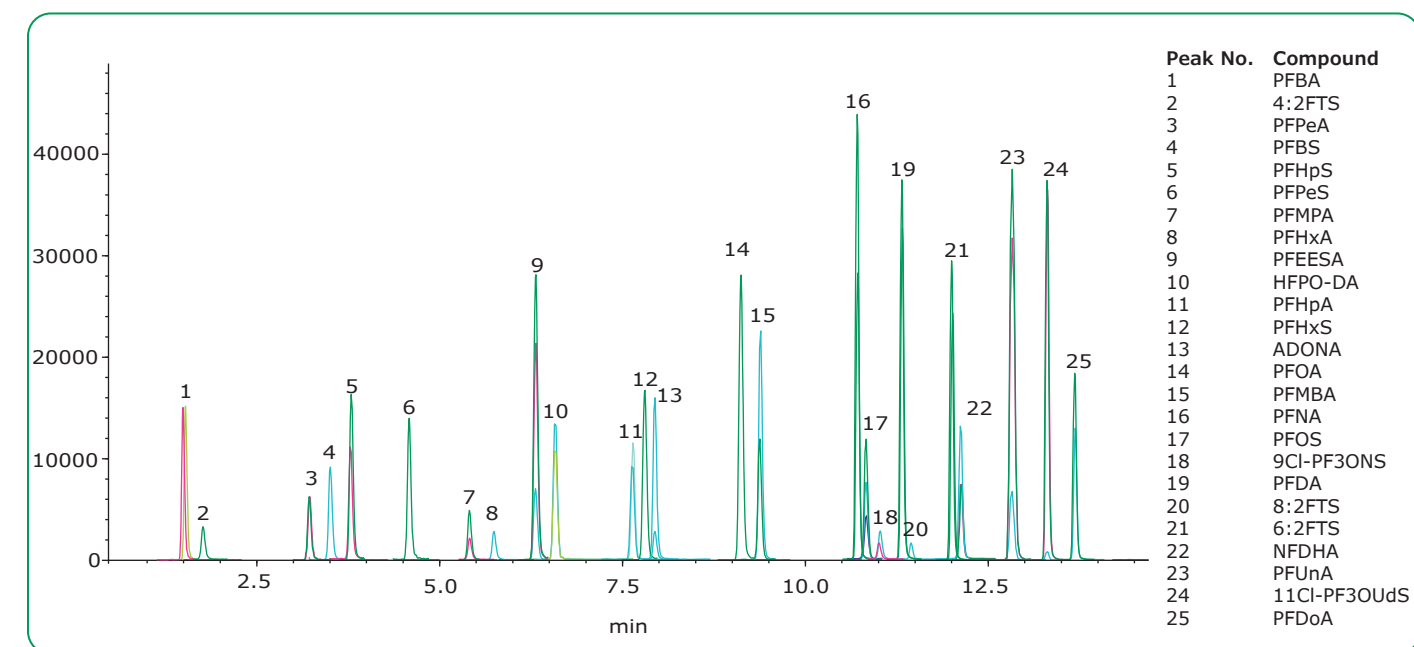
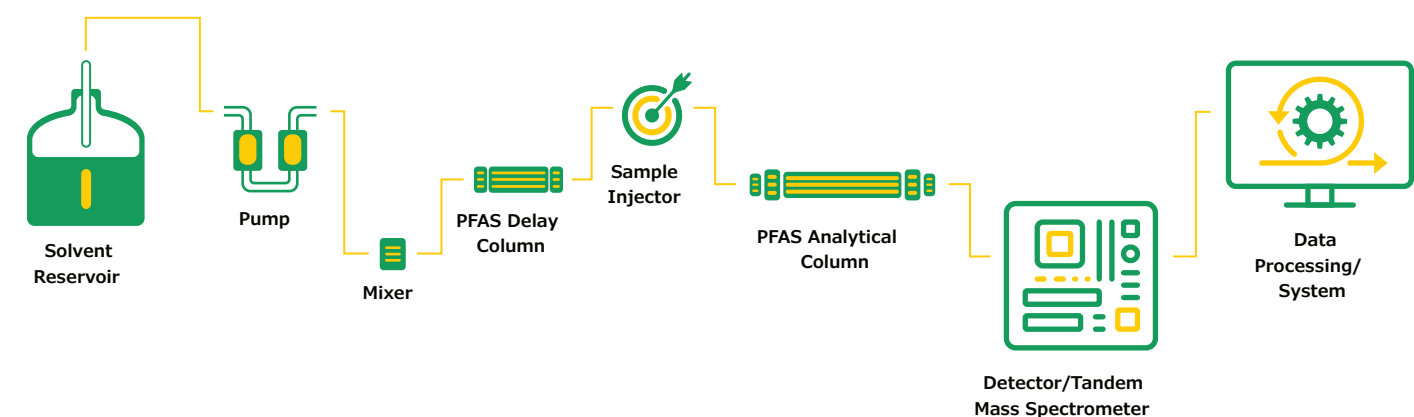

Access full application data:

[LC-MS Analysis of PFAS Compounds in EPA Methods 537.1, 533 and 8327](#) | [LC-MS Analysis of 33 PFAS Compounds in 5 minutes](#)

Ordering Information Ascentis® Express PAH and PFAS HPLC Columns

Column dimension

Length (mm)	I.D. (mm)	PAH	PFAS
50	x 2.1	53513-U	53557-U
100	x 2.1	53532-U	53559-U
150	x 2.1	53533-U	53560-U
250	x 2.1		53562-U
50	x 3	53534-U	53563-U
100	x 3	53535-U	53564-U
150	x 3	53538-U	53565-U
250	x 3		53570-U
50	x 4.6	53539-U	

Length (mm)	I.D. (mm)	PAH	PFAS
100	x 4.6	53540-U	
150	x 4.6	53541-U	
250	x 4.6	53550-U	
Guard Columns		Delay column	
50	x 2.1	53551-U	
50	x 3	53555-U	53572-U
50	x 4.6	53556-U	53573-U

Ordering information

Ascentis® Express (5 µm)

Length (mm)	I.D. (mm)	C18	C8	RP-Amide	Phenyl-Hexyl	Biphenyl	F5 (PFP)	ES-Cyano	OH5	HILIC (Si)
20	x 2.1	50507-U	50362-U	50732-U	50442-U	on request	50603-U	50557-U	50313-U	50255-U
30	x 2.1	50508-U	50363-U	50733-U	50443-U	on request	50604-U	50558-U	50314-U	50256-U
50	x 2.1	50509-U	50364-U	50734-U	50446-U	584585-U	50605-U	50559-U	50317-U	50257-U
75	x 2.1	50511-U	50367-U	50735-U	50451-U	on request	50607-U	50562-U	50321-U	50258-U
100	x 2.1	50517-U	50368-U	50737-U	50454-U	584586-U	50612-U	50563-U	50322-U	50260-U
150	x 2.1	50518-U	50372-U	50739-U	50455-U	584587-U	50613-U	50564-U	50327-U	50261-U
250	x 2.1	50521-U	50373-U	50747-U	50456-U	584588-U	50614-U	50566-U	50328-U	50262-U
30	x 3.0	50522-U	50376-U	50749-U	50459-U	584589-U	50615-U	50567-U	50329-U	50264-U
50	x 3.0	50523-U	50377-U	50751-U	50464-U	584590-U	50616-U	50568-U	50335-U	50265-U
75	x 3.0	50525-U	50378-U	50752-U	50466-U	on request	50619-U	50569-U	50336-U	50268-U
100	x 3.0	50526-U	50381-U	50753-U	50469-U	584591-U	50622-U	50570-U	50338-U	50269-U
150	x 3.0	50527-U	50382-U	50758-U	50470-U	584592-U	50623-U	50574-U	50339-U	50270-U
250	x 3.0	50528-U	50385-U	50759-U	50472-U	on request	50624-U	50575-U	50341-U	50276-U
30	x 4.6	50529-U	50386-U	50767-U	50474-U	584593-U	50625-U	50577-U	50343-U	50278-U
50	x 4.6	50530-U	50389-U	50768-U	50477-U	584594-U	50626-U	50581-U	50344-U	50284-U
75	x 4.6	50533-U	50390-U	on request	50479-U	on request	50627-U	50583-U	50345-U	50286-U
100	x 4.6	50536-U	50391-U	50773-U	50482-U	584595-U	50628-U	50585-U	50346-U	50288-U
150	x 4.6	50537-U	50392-U	50774-U	50483-U	584596-U	50631-U	50588-U	50347-U	50289-U
250	x 4.6	50538-U	50394-U	50775-U	50487-U	on request	50632-U	50591-U	50348-U	50294-U
Guard 5 mm	x 2.1 mm	50539-U	50395-U	50776-U	50496-U	584597-U	50633-U	50592-U	50349-U	50295-U
Guard 5 mm	x 3 mm	50541-U	50396-U	50777-U	50497-U	584598-U	50634-U	50593-U	50350-U	50297-U
Guard 5 mm	x 4.6 mm	50542-U	50399-U	50779-U	50498-U	584599-U	50635-U	50597-U	50355-U	50298-U

Ascentis® Express (2.7 µm)

Length (mm)	I.D. (mm)	C30	C18	AQ-C18	Peptide ES-C18	C18*, PCP	C8	RP-Amide	Phenyl-Hexyl	Biphenyl	F5 (PFP)	ES-Cyano	OH5	HILIC (Si)
20	x 2.1	on request	53799-U	577320-U	on request	on request	53795-U	on request	on request	64043-U	53592-U	53494-U	53779-U	
30	x 2.1	on request	53802-U	577321-U	53299-U	on request	53839-U	53910-U	53332-U	64054-U	53566-U	53468-U	53748-U	53933-U
50	x 2.1	577100-U	53822-U	577322-U	53301-U	on request	53831-U	53911-U	53334-U	64057-U	53567-U	53470-U	53749-U	53934-U
75	x 2.1	on request	53804-U	577323-U	53304-U	on request	53843-U	53912-U	53335-U	64061-U	53568-U	53472-U	53755-U	53938-U
100	x 2.1	577101-U	53823-U	577324-U	53306-U	on request	53832-U	53913-U	53336-U	64065-U	53569-U	53473-U	53757-U	53939-U
150	x 2.1	577102-U	53825-U	577325-U	53307-U	on request	53834-U	53914-U	53338-U	64068-U	53571-U	53475-U	53764-U	53946-U
250	x 2.1	577103-U	on request	on request	on request	on request	on request	on request	on request	on request	on request	on request	on request	on request
20	x 3.0	on request	on request	577326-U	on request	on request	on request	on request	on request	64047-U	on request	on request	on request	on request
30	x 3.0	577104-U	53805-U	577327-U	53308-U	on request	53844-U	53915-U	53341-U	64055-U	53574-U	53476-U	53766-U	53964-U
50	x 3.0	577105-U	53811-U	577328-U	53311-U	on request	53848-U	53916-U	53342-U	64058-U	53576-U	53478-U	53767-U	53967-U
75	x 3.0	on request	53812-U	577329-U	53312-U	on request	53849-U	53917-U	53343-U	64062-U	53577-U	53479-U	53768-U	53969-U
100	x 3.0	577106-U	53814-U	577330-U	53313-U	on request	53852-U	53918-U	53345-U	64066-U	53578-U	53481-U	53769-U	53970-U
150	x 3.0	577107-U	53816-U	577331-U	53314-U	on request	53853-U	53919-U	53346-U	64069-U	53579-U	53483-U	53771-U	53972-U
20	x 4.6	on request	on request	577332-U	on request	on request	on request	on request	on request	64051-U	on request	on request	on request	on request
30	x 4.6	577108-U	53818-U	577333-U	53316-U	on request	53857-U	53921-U	53347-U	64056-U	53581-U	53484-U	53772-U	53974-U
50	x 4.6	577134-U	53826-U	577334-U	53318-U	on request	53836-U	53922-U	53348-U	64059-U	53583-U	53486-U	53774-U	53975-U
75	x 4.6	on request	53819-U	577335-U	53323-U	on request	53858-U	53923-U	53351-U	64064-U	53584-U	53489-U	53775-U	53977-U
100	x 4.6	577135-U	53827-U	577336-U	53324-U	50461-U	53837-U	53929-U	53352-U	64067-U	53590-U	53491-U	53776-U	53979-U
150	x 4.6	577136-U	53829-U	577337-U	53328-U	50462-U	53838-U	53931-U	53353-U	64071-U	53591-U	53492-U	53778-U	53981-U
Guard 5	x 2.1	577137-U	53501-U	577338-U	53536-U	on request	53509-U	53514-U	53524-U	64074-U	53594-U	53495-U	53780-U	53520-U
Guard 5	x 3	577138-U	53504-U	577339-U	53537-U	on request	53511-U	53516-U	53526-U	64076-U	53597-U	53496-U	53781-U	53521-U
Guard 5	x 4.6	577139-U	53508-U	577340-U	53542-U	on request	53512-U	53519-U	53531-U	64078-U	53599-U	53497-U	on request	53523-U

*Ascentis® Express C18 PCP: pre-conditioned with phosphoric acid.

HPLC Columns "on request" are available as Custom Product. Please see page 120/121

Ascentis® Express UHPLC Columns

Ascentis® Express (2 µm)

Length (mm)	I.D. (mm)	C18	C8	RP-Amide	Phenyl-Hexyl	Biphenyl	F5 (PFP)	ES-Cyano	OH5	HILIC (Si)
20	x 2.1	50805-U	51652-U	51567-U	51600-U	on request	50857-U	51709-U	50951-U	51403-U
30	x 2.1	50809-U	51654-U	51568-U	51601-U	on request	50858-U	51712-U	50952-U	51404-U
50	x 2.1	50811-U	51656-U	51569-U	51603-U	584600-U	50859-U	51717-U	50957-U	51406-U
75	x 2.1	50812-U	51657-U	51571-U	51605-U	on request	50861-U	51721-U	50958-U	51408-U
100	x 2.1	50813-U	51658-U	51576-U	51608-U	584601-U	50863-U	51724-U	50959-U	51409-U
150	x 2.1	50814-U	51661-U	51577-U	51609-U	584602-U	50867-U	51725-U	50962-U	51418-U
250	x 2.1	on request	on request	on request	on request	584603-U	on request	on request	on request	on request
30	x 3	50815-U	51663-U	51582-U	51611-U	584604-U	50869-U	51727-U	50963-U	51419-U
50	x 3	50816-U	51664-U	51583-U	51614-U	584605-U	50871-U	51728-U	50964-U	51421-U
75	x 3	50817-U	51672-U	51587-U	51616-U	on request	50876-U	51729-U	50965-U	51424-U
100	x 3	50819-U	51673-U	51588-U	51617-U	on request	50879-U	51732-U	50967-U	51428-U
150	x 3	50821-U	51674-U	51589-U	51618-U	584606-U	50881-U	51734-U	50968-U	51429-U
Guard 5 mm	x 2.1	50822-U	51676-U	51594-U	51619-U	584607-U	50884-U	51736-U	50969-U	51430-U
Guard 5 mm	x 3	on request	51679-U	51595-U	51623-U	584608-U	50886-U	51739-U	50973-U	51433-U

Ascentis® Express Guard Cartridge Holder 53500-U

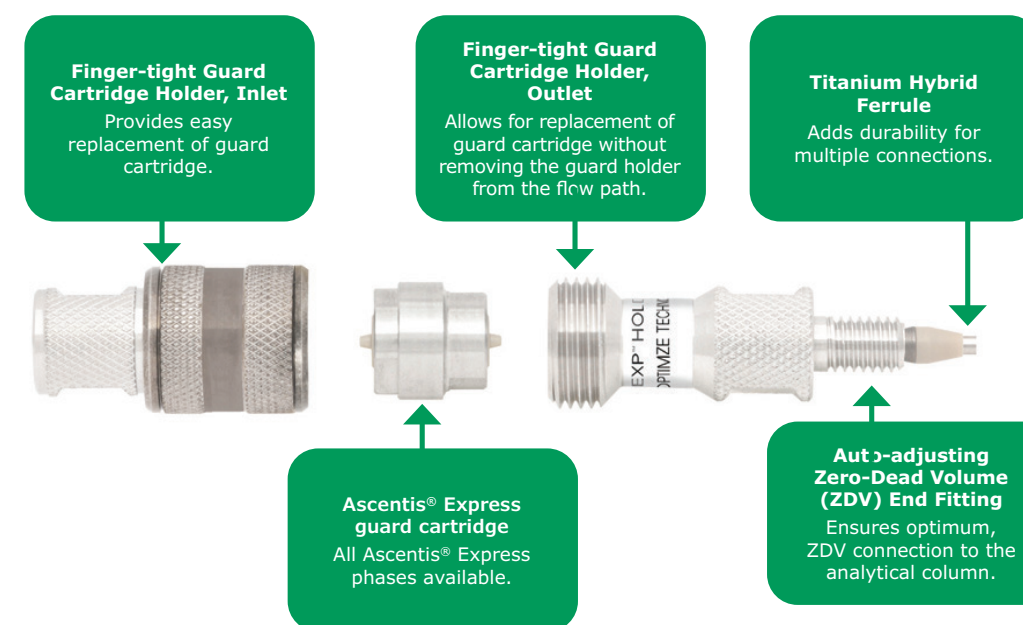

Ascentis® Express Capillary columns (2.7 µm)

Length (mm)	I.D. (mm)	C18	Peptide ES-C18	C8
50	x 0.075	53982-U	53543-U	53983-U
50	x 0.100	53985-U	53544-U	53987-U
50	x 0.200	53989-U	53545-U	53991-U
50	x 0.300	53992-U	53546-U	53997-U
50	x 0.500	53998-U	53547-U	53999-U
50	x 1		53548-U	
150	x 0.075	54219-U	53549-U	54229-U
150	x 0.100	54256-U	53552-U	54260-U
150	x 0.200	54261-U	53553-U	54262-U
150	x 0.300	54271-U	53554-U	54272-U
150	x 0.500	54273-U	53558-U	54275-U
150	x 1		53561-U	

Ascentis® Express (2 µm)

BIOshell™ HPLC and UHPLC Columns

Maximum Resolution for Glycan, Peptide, Protein, and IgG Separation

As the pharmaceutical and biotechnology industries continuously evolve into the development of “large molecule” biotherapeutics to treat a myriad of diseases, both fast and high-resolution separations are required in order to resolve the numerous structural variants that exist in these complex samples. The BIOshell™ line of superficially porous particle (SPP) packed columns has been developed to aid research into understanding the subtleties of the molecule that is being developed.

Highlighted Applications for these columns include:

- Top-down analysis of intact proteins, monoclonal antibodies (mAbs), antibody-drug conjugates (ADCs), and other large biomolecules.

- Bottom-up analysis (peptide mapping) of proteins for primary structure confirmation
- Middle-up analysis of mAb fragments (light and heavy chains)
- High resolution separation of released N- and O-linked glycans.

Features and Benefits

- Application specific columns for bioseparations that outperform fully porous particulate silica columns
- Significantly higher separation efficiency
- Offer better peak shape and peak capacity
- Breakthrough 1000 Å pore diameter particles for large molecule enablement

Column Selection Guide for Biomolecule Separations

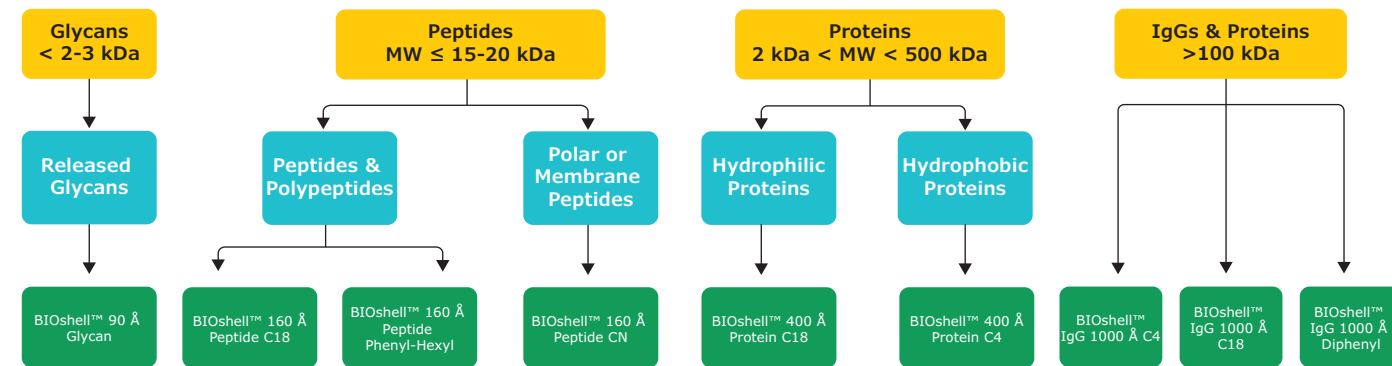

Pore Size Mismatch Can Lead to Significant Losses in Efficiency

Column:	BIOshell™ A160 Peptide C18, 15 cm x 2.1 mm I.D., 2.7 μm; BIOshell™ A400 Protein C18, 15 cm x 2.1 mm I.D., 3.4 μm; BIOshell™ IgG 1000 Å C18, 15 cm x 2.1 mm I.D., 2.7 μm;
Mobile phase:	[A] Water (0.1% v/v trifluoroacetic acid); [B] 20:80 Water:Acetonitrile (0.085% v/v trifluoroacetic acid)
Gradient:	27% B to 60% B in 15 min
Flow rate:	0.4 mL/min
Column temp.:	60 °C
Detector:	UV, 280 nm
Injection:	4 μL
Sample:	Proteins, varied concentration, water (0.1% v/v trifluoroacetic acid)

1. Ribonuclease A (13.8 kDa)
2. Lysozyme (14.4 kDa)
3. SILu™ Lite SigmaMAb Antibody (~150 kDa)
4. Enolase (46.7 kDa)

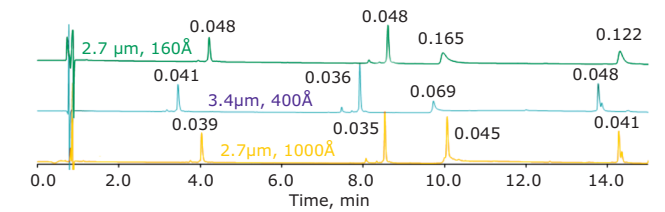

Higher efficiencies and better sensitivity can be realized with proper pore diameter selection. Here, the 1000 Å pore diameter is the only one capable of providing good peak shape of the mAb (peak 3) analyte.

BIOshell™ HPLC and UHPLC Columns

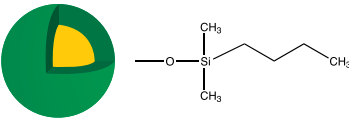
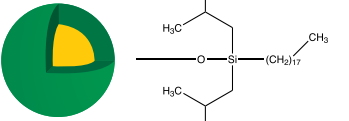
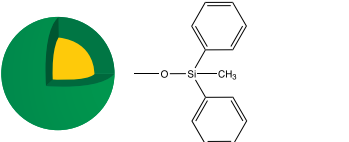
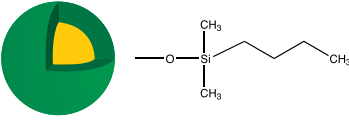
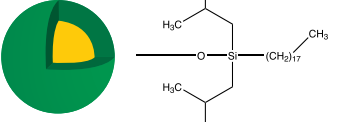
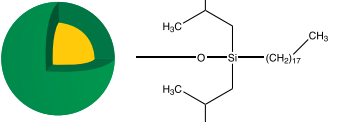
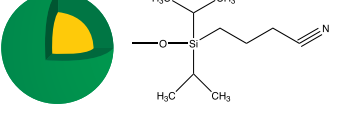
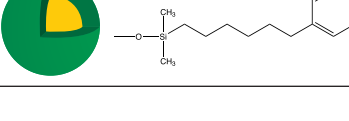
	Molecule size	Properties	Applications	Bonded Phase	USP Designation	Bonding Chemistry	Particle Sizes (s) (µm)	Pore Size (Å)	Carbon Load (%)	Surface Area (m ² /g)	Low pH /T Limit	High pH /T Limit	Endcapped
IgG	Large (> 50 kDa)	Largest pore diameter in the portfolio allowing for unrestricted access of proteins and other large molecules. Compatible for UHPLC, HPLC, and mass spectrometry (MS). C4, C18, and Diphenyl phase chemistries provide different selectivities. Resolution of very large proteins with superior peak shape and efficiency as compared to separations on FPP-packed columns.	mAbs; ADCs; Biosimilars; H/D Exchange; mAb Fragments	 C4	L26	Dimethylbutylsilane	2.7	1000	0.6	22	2/90 °C	9/40 °C	Yes
				 C18	L1	Diisobutyloctadecylsilane	2.7	1000	1.4	22	1/90 °C	8/40 °C	Yes
				 Diphenyl	L11	Diphenylmethylsilane	2.7	1000	1.0	22	2/90 °C	9/40 °C	Yes
Protein	Large (2 kDa < MW < 500 kDa)	Fast separation of biomolecules due to a more shallow shell. Temperature stable up to 90 °C enabling high efficiency separations perfect for UHPLC, HPLC, and LC-MS assays. C4 and C18 chemistries provide different selectivities for hydrophobic and hydrophilic proteins. Resolution of large proteins with superior peak shape and efficiency as compared to separations on FPP-packed columns.	mAbs; ADCs; Biosimilars; Proteins; mAb Fragments	 C4	L26	Dimethylbutylsilane	3.4	400	0.4	15	2/90 °C	9/40 °C	Yes
				 C18	L1	Diisobutyloctadecylsilane	3.4	400	1.0	15	1/90 °C	8/40 °C	Yes
Peptide	Medium (0.1 kDa < MW < 15 kDa)	Wide range of particle sizes for both high efficiency separations and high throughput. Peak capacities of columns capable of resolving complex peptide mixtures.	Tryptic Digests; Post-Translational Modifications (PTMs); Polypeptides	 C18	L1	Diisobutyloctadecylsilane	2	160	4.0	65	1/90 °C	8/40 °C	No
							2.7	160	4.6	90	1/90 °C	8/40 °C	No
							5	160	4.0	60	1/90 °C	8/40 °C	No
				 Cyano	L10	Diisopropylcyanopropylsilane	2.7	160	2.2	90	1/90 °C	8/40 °C	Yes
 Phenyl-Hexyl	L11	Dimethylphenyl-hexylsilane	2.7	160	4.7	90	2/90 °C	9/40 °C	Yes				
Glycan	Small (< 20 kDa*) *for glycans, glycopeptides, and glycoproteins	Improved retention of polar compounds and zwitterions as compared to bare silica. Resolution of peaks unaffected by slight changes in buffer concentration. Capable of resolving complex mixtures of glycans (isobaric glycans with different linkages).	Resolution of oligosaccharides (released and labeled glycans) via hydrophilic interaction liquid chromatography (HILIC).	Proprietary Ligand	L95	Penta-hydroxy	2.7	90	3.2	135	2/65 °C	9/40 °C	No

BIOshell™ IgG 1000 Å U/HPLC Columns: Maximizing Pore Diameter to Minimize Size Exclusion

- A 1000 Å pore diameter allows unrestricted access of large biomolecules into the particles.
- Superficially Porous Particles (SPPs) provide narrower peak widths and improved resolution for characterization of biomolecules in comparison to fully Porous Particles (FPPs).
- Post-translational modifications (PTMs) of expressed proteins can lead to subtle differences in molecular structure and function of the protein. These minor variants can be resolved with BIOshell™ IgG 1000 Å columns.
- Three different phase chemistries (C4, C18 and Diphenyl) for optimal selectivity

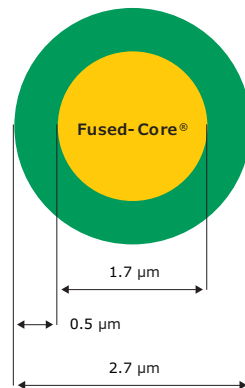

Effect of Phase Chemistry on Protein Selectivity

Column:	BIOshell™ IgG 1000 Å C4, 15 cm x 2.1 mm I.D., 2.7 µm; BIOshell™ IgG 1000 Å C18, 15 cm x 2.1 mm I.D., 2.7 µm; BIOshell™ IgG 1000 Å Diphenyl, 15 cm x 2.1 mm I.D., 2.7 µm
Mobile phase:	[A] 2:10:88 n-propanol/acetonitrile/water (0.1% v/v difluoroacetic acid); [B] 70:20:10 n-propanol/acetonitrile/water (0.1% v/v difluoroacetic acid)
Gradient:	16% B to 26% B in 20 min
Flow rate:	0.2 mL/min
Column temp.:	80 °C
Detector:	UV, 280 nm
Injection:	2 µL
Sample:	Denosumab, 2 mg/mL, water (0.1% v/v trifluoroacetic acid)

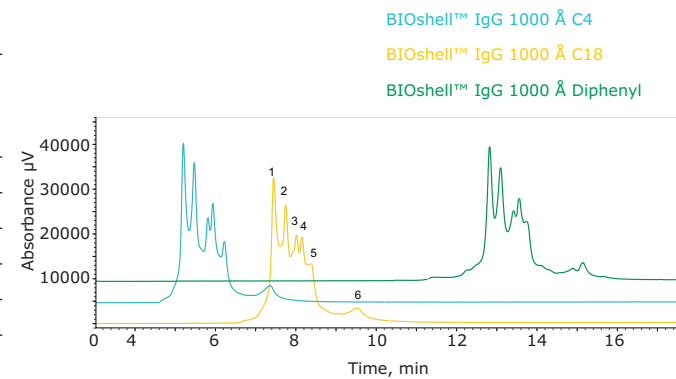

Monoclonal antibodies are unique molecules and therefore can interact differently with different phase chemistries. The numbered peaks correspond to IgG2 disulfide bond variants.

BIOshell™ A400 Protein U/HPLC Columns: Minimizing Mass Transfer for Maximum Throughput

- A 0.2 µm-thin, porous shell with 400 Å pores leads to rapid and efficient separations of proteins.
- Superficially Porous Particles (SPPs) provide narrower peak widths and improved resolution for characterization of biomolecules
- in comparison to fully Porous Particles (FPPs).
- Ability to tolerate high temperature applications (up to 90 °C) in acidic mobile phases.
- Two different phase chemistries (C4 and C18) for rapid protein separation

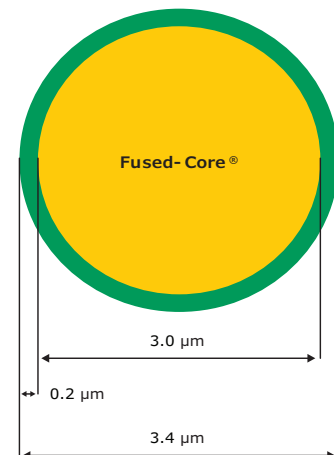

Rapid Protein Separations on BIOshell™ A400

Column:	BIOshell™ A400 Protein C4, 5 cm x 2.1 mm I.D., 3.4 µm
Mobile phase:	[A] 75:25 (0.1% TFA in water):(0.1% TFA in acetonitrile); [B] 25:75 (0.1% TFA in water):(0.1% TFA in acetonitrile)
Gradient:	12 to 100% B in 1 min; held at 100% B for 1 min
Flow rate:	0.4 mL/min
Column temp.:	90 °C
Detector:	UV, 215 nm
Injection:	1 µL
Sample:	Protein mix, varied concentration, water (0.1% TFA)

Due to the shallow, porous shell, protein separations can be performed in less than one minute with the BIOshell™ A400 column.

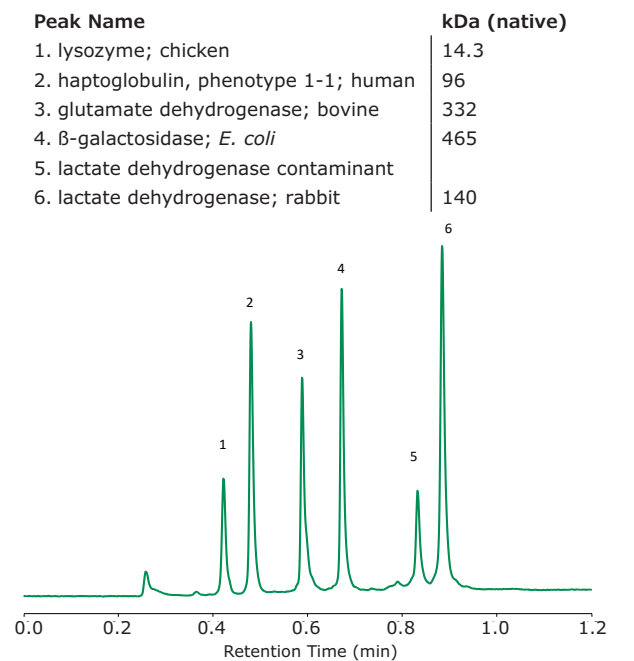

BIOshell™ A160 Peptide U/HPLC Columns: High Resolution Peptide Separations

- BIOshell™ A160 Peptide U/HPLC columns offer a broad portfolio of particle sizes and phase chemistries to create a superior solution for fast and efficient separations of peptides up to 20 kDa.
- Higher resolutions and higher peak capacities of peptides at ~ 50% backpressure of sub-2 µm Fully Porous Particle (FPP)-packed columns.
- Lower backpressure allows for columns to be used in series to maximize resolution and peak capacity of complex proteomic samples or tryptic digests.
- Compatible with all UHPLC and LC-MS instrumentation.
- Three different particle sizes and phase chemistries (Phenyl-Hexyl, C18 and Cyano) for fast peptide separations

Rapid Tryptic Digest Analysis Using BIOshell™ A160 Peptide C18

Column:	BIOshell™ A160 Peptide C18, 15 cm x 4.6 mm I.D., 5.0 µm
Mobile phase:	[A] Water (0.1% TFA); [B] Acetonitrile (0.1% TFA)
Gradient:	As indicated
Flow rate:	As indicated
Column temp.:	60 °C
Detector:	UV, 215 nm
Injection:	15 µL
Sample:	Tryptic digest, 1 mg/mL, water (0.1% TFA)

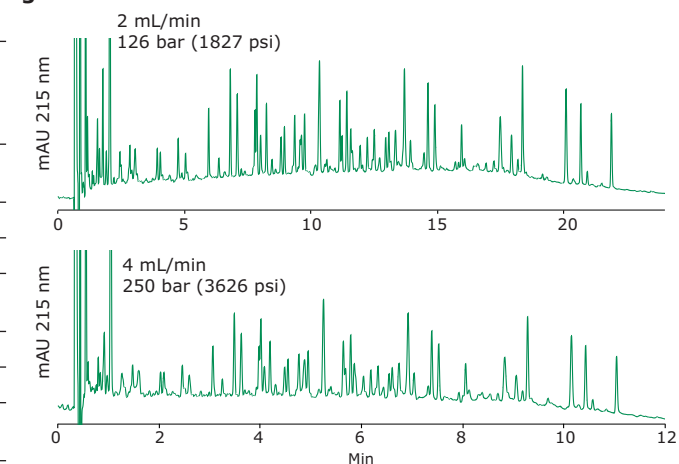

BIOshell™ A160 Peptide columns can more than double sample throughput by allowing the analyst to operate at higher flow rates without a concomitant drop in efficiency.

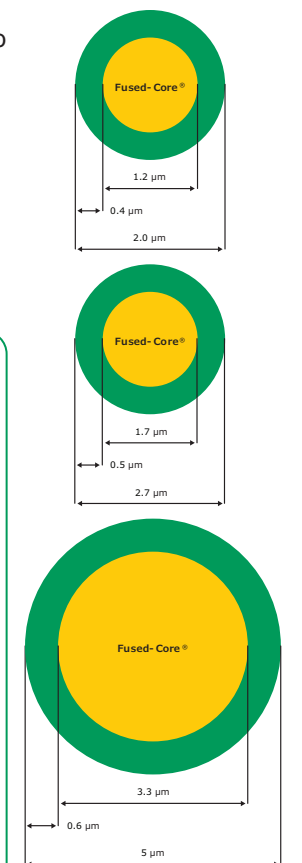

BIOshell™ Glycan U/HPLC Columns: High Resolution Glycan Separations

- BIOshell™ Glycan U/HPLC columns consist of a proprietary, pentahydroxy chemistry tethered to a 2.7 µm, 90 Å superficially porous particle (SPP).
- Appropriate for USP L95 methods.
- Main application is for the resolution of oligosaccharides (released and labeled glycans) via hydrophilic interaction liquid chromatography (HILIC).

- Increased retention of acidic and zwitterionic analytes than bare silica columns.
- Each lot of BIOshell™ Glycan particles is tested for quality control by separation of a series of labeled glycans having 2 – 25 glucose units (GU).

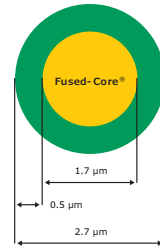

HPLC Analysis of Procainamide-Labeled Human IgG Glycans on BIOshell™ Glycan using HILIC-FLR

Column:	BIOshell™ Glycan, 15 cm x 2.1 mm I.D., 2.7 µm
Mobile phase:	[A] 50 mM ammonium formate, pH 4.4 (50 mM ammonium hydroxide, adjusted to pH 4.4 with formic acid); [B] acetonitrile
Gradient:	75% B to 59% B in 75 min
Flow rate:	0.3 mL/min
Temp.:	60 °C
Detector:	FLR, ex 308 nm, em 359 nm
Injection vol:	10 µL
Sample:	Released human IgG glycans

Excellent resolution and peak shape of released glycans.

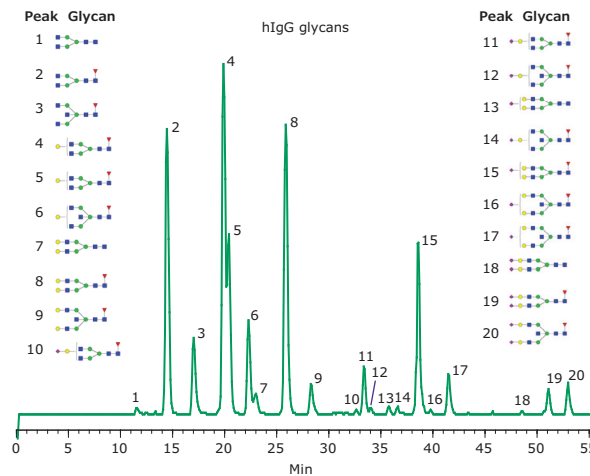

Ordering Information

BIOshell™ IgG 1000 Å (2.7 µm)

Length (mm)	I.D. (mm)	C18	C4	Diphenyl
20	x 2.1	63281-U	on request	on request
30	x 2.1	63282-U	on request	on request
50	x 2.1	581362-U	63283-U	577419-U
75	x 2.1	63284-U	on request	on request
100	x 2.1	582701-U	63288-U	577420-U
150	x 2.1	582703-U	63289-U	577421-U
250	x 2.1	582704-U	on request	577422-U
20	x 3.0	63306-U	on request	on request
30	x 3.0	582705-U	63307-U	577423-U
50	x 3.0	582706-U	63308-U	577424-U
75	x 3.0	63311-U	on request	on request
100	x 3.0	582707-U	63313-U	577425-U
150	x 3.0	582708-U	63314-U	577426-U
20	x 4.6	63322-U	on request	on request
30	x 4.6	582709-U	63324-U	577427-U
50	x 4.6	582710-U	63325-U	577428-U
75	x 4.6	63327-U	on request	on request
100	x 4.6	582713-U	63328-U	577429-U
150	x 4.6	581348-U	63329-U	577430-U
Guard 5	x 2.1	581349-U	63291-U	577431-U
Guard 5	x 3.0	581360-U	63315-U	577432-U
Guard 5	x 4.6	581361-U	63334-U	577433-U

BIOshell™ A160 Peptide (2.7 µm)

Length (mm)	I.D. (mm)	C18	CN	Phenyl-Hexyl
20	x 2.1	on request	on request	577523-U
30	x 2.1	66901-U	66965-U	577524-U
50	x 2.1	66902-U	66966-U	577525-U
75	x 2.1	66903-U	66967-U	577526-U
100	x 2.1	66904-U	66968-U	577527-U
150	x 2.1	66905-U	66969-U	577528-U
20	x 3.0	on request	on request	577529-U
30	x 3.0	66906-U	66970-U	577530-U
50	x 3.0	66907-U	66971-U	577531-U
75	x 3.0	on request	on request	577532-U
100	x 3.0	66908-U	66972-U	577533-U
150	x 3.0	66909-U	66973-U	577534-U
20	x 4.6	on request	on request	577535-U
30	x 4.6	on request	on request	577536-U
50	x 4.6	66913-U	66974-U	577537-U
75	x 4.6	on request	on request	577538-U
100	x 4.6	66915-U	66975-U	577539-U
150	x 4.6	on request	66976-U	577540-U
Guard 5	x 2.1	66918-U	66977-U	577541-U
Guard 5	x 3.0	66919-U	66978-U	577542-U
Guard 5	x 4.6	66921-U	66979-U	577543-U



HPLC Columns "on request" are available as Custom Product. Please see page 120/121

BIOshell™ A160 Peptide (2.0 µm)

Length (mm)	I.D. (mm)	C18
20	x 2.1	67234-U
30	x 2.1	67238-U
50	x 2.1	67239-U
75	x 2.1	67241-U
100	x 2.1	67242-U
150	x 2.1	67243-U
20	x 3.0	67257-U
30	x 3.0	67263-U
50	x 3.0	67267-U
75	x 3.0	67274-U
100	x 3.0	67275-U
150	x 3.0	67277-U
Guard 5	x 2.1	67281-U
Guard 5	x 3.0	67282-U

BIOshell™ A160 Peptide C18 (2.7 µm) Capillary Columns

Length (mm)	I.D. (mm)	C18	CN
50	x 0.075	67085-U	67150-U
150	x 0.075	67086-U	67152-U
50	x 0.1	67087-U	67153-U
150	x 0.1	67088-U	67155-U
50	x 0.2	67089-U	67157-U
150	x 0.2	67091-U	67158-U
50	x 0.3	67092-U	67159-U
150	x 0.3	67093-U	67160-U
50	x 0.5	67095-U	67161-U
100	x 0.5	67096-U	on request
150	x 0.5	67097-U	67163-U
50	x 1.0	67098-U	67164-U
150	x 1.0	67099-U	67165-U

BIOshell™ A400 Protein C4 (3.4 µm)

Length (mm)	I.D. (mm)	C18	C4
20	x 2.1	67457-U	on request
30	x 2.1	67458-U	on request
50	x 2.1	67459-U	66824-U
75	x 2.1	67462-U	on request
100	x 2.1	67463-U	66825-U
150	x 2.1	67469-U	66826-U
20	x 3.0	67471-U	on request
30	x 3.0	67472-U	on request
50	x 3.0	67473-U	on request
75	x 3.0	67474-U	on request
100	x 3.0	67475-U	on request
150	x 3.0	67477-U	on request
20	x 4.6	67478-U	on request
30	x 4.6	67482-U	on request
50	x 4.6	67483-U	66827-U
75	x 4.6	67485-U	on request
100	x 4.6	67487-U	66828-U
150	x 4.6	67488-U	66829-U
Guard 5	x 2.1	67505-U	66830-U
Guard 5	x 3.0	67506-U	on request
Guard 5	x 4.6	67508-U	66831-U

BIOshell™ A160 Peptide (5.0 µm)

Length (mm)	I.D. (mm)	C18	CN
30	x 2.1	67001-U	67061-U
50	x 2.1	67002-U	67062-U
75	x 2.1	67003-U	67063-U
100	x 2.1	67004-U	67064-U
150	x 2.1	67006-U	67065-U
30	x 3.0	67007-U	67066-U
50	x 3.0	67008-U	67067-U
100	x 3.0	67011-U	67068-U
150	x 3.0	67012-U	67069-U
50	x 4.6	67013-U	67071-U
100	x 4.6	67014-U	67080-U
150	x 4.6	67015-U	67081-U
Guard 5	x 2.1	67016-U	67082-U
Guard 5	x 3.0	67017-U	67083-U
Guard 5	x 4.6	67018-U	67084-U

BIOshell™ A160 Peptide C18 (5.0 µm) Capillary Columns

Length (mm)	I.D. (mm)	C18	CN
50	x 0.075	67201-U	67305-U
150	x 0.075	67202-U	67307-U
50	x 0.1	67203-U	67311-U
150	x 0.1	67204-U	67312-U
50	x 0.2	67205-U	67314-U
150	x 0.2	67206-U	67315-U
50	x 0.3	67207-U	67321-U
150	x 0.3	67208-U	67324-U
50	x 0.5	67209-U	67325-U
150	x 0.5	67212-U	67326-U
50	x 1.0	67215-U	67327-U
150	x 1.0	67219-U	67329-U

BIOshell™ A400 Protein C4 (3.4 µm) Capillary Columns

Length (mm)	I.D. (mm)	C18	C4
50	x 0.075	67489-U	67031-U
150	x 0.075	67490-U	67032-U
50	x 0.1	67491-U	67033-U
150	x 0.1	67493-U	67034-U
50	x 0.2	67494-U	67036-U
150	x 0.2	67495-U	67037-U
50	x 0.3	67496-U	67038-U
150	x 0.3	67497-U	67039-U
50	x 0.5	67499-U	67040-U
150	x 0.5	67502-U	67041-U
50	x 1.0	67503-U	67042-U
150	x 1.0	67504-U	67045-U

BIOshell™ Glycan (2.7 µm)

Length (mm)	I.D. (mm)	p/n
50	x 2.1	50991-U
100	x 2.1	50993-U
150	x 2.1	50994-U
50	x 4.6	50997-U
100	x 4.6	50998-U
150	x 4.6	50999-U

HPLC Columns "on request" are available as Custom Product. Please see page 120/121

Monolithic Silica HPLC Columns

Revolutionary monolithic silica for rapid and robust separations

Thanks to their patented monolithic silica technology, Chromolith® HPLC columns allow you to race through separations with maximum robustness and selectivity—at minimal back pressure.

Macropores

To truly accelerate chromatographic separations, there is no better choice than Chromolith® HPLC columns. Due to their revolutionary, monolithic technology, Chromolith® columns provide excellent and rapid separations with extremely high robustness and matrix tolerance compared to particulate columns.

The secret to the speed of Chromolith® columns is their exceptionally low back pressure. Produced from a continuous piece of porous silica using a sol-gel process, Chromolith® columns possess a defined bimodal pore structure with macro and mesopores in the micro and nanometer range. The high permeability and porosity of the silica skeleton, and the resulting low back pressure, allow for more flexible flow rates than particle-packed columns. As a result, Chromolith® HPLC columns enable high-throughput analysis without loss of separation efficiency or peak capacity.

The revolutionary, bimodal pore structure of Chromolith® columns provides a unique combination of macropores and mesopores.

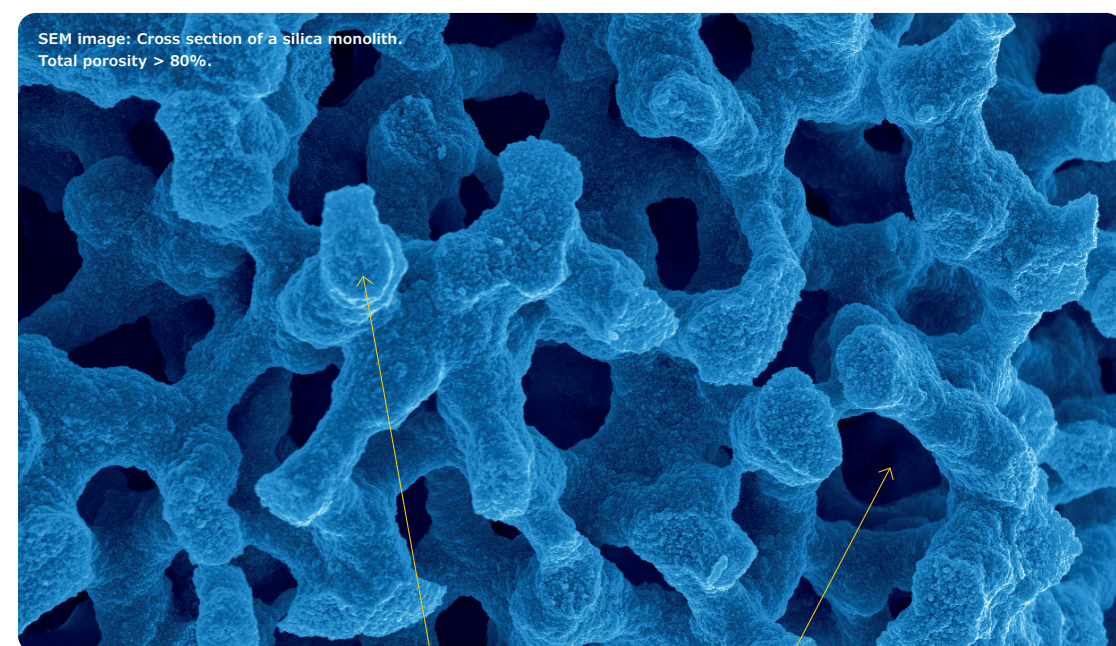

Mesopores: Average pore size is 13 nm for Chromolith®, 15 nm for Chromolith®HR, and 30 nm for Chromolith®WP 300.

Forms a fine porous structure with a large, uniform surface area on which adsorption takes place, thus enabling high-performance chromatographic separation.

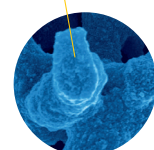

Macropores: Average pore size is 1.5 µm for Chromolith® 2 mm I.D., 1.15 µm for Chromolith® HR, and 2 µm for all others.

Allows rapid flow of the mobile phase at low back pressure.

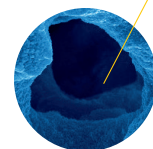

Chromolith® Pore Sizes

	Mesopores	Macropores
Chromolith® Performance	13 nm (130 Å)	2 µm
Chromolith® 2 mm ID	13 nm (130 Å)	1.5 µm
Chromolith® HighResolution	15 nm (150 Å)	2 µm
Chromolith® WP 300	30 nm (300 Å)	2 µm

Chromolith® HPLC Columns for small and large molecule separation

Several key benefits result directly from the bimodal pore structure of the silica gel:

- Rapid separations at very low column back-pressure
- Standard HPLC instruments are fully compatible with all Chromolith® columns and UHPLC instruments are fully compatible with Chromolith® 2 mm I.D. columns.
- Matrix-rich samples (such as food or biological samples) can be analyzed without the need for sophisticated and time-consuming sample preparation. Guard column cartridges are also available.
- Cost-savings are achieved as the column lifetimes are much longer than for particulate HPLC columns, in particular when analyzing matrix-rich samples.
- Complex, multi-component samples can be separated either by using Chromolith® HighResolution (HR) columns or by using long, very high-efficiency columns formed by connecting two or more Chromolith® columns together. The low column backpressure makes this possible.
- Easy transfer of methods from a particulate column to a Chromolith® column.

The columns are available with several surface modifications such as octadecyl (RP-18e) or octyl (RP-8e) endcapped, Phenyl, CN (nitrile), Diol and NH₂ (amino) as well as an unmodified pure silica. The available column dimensions range from Capillary (Nano) columns to preparative HPLC columns with 25 mm ID.

	Column Dimensions
HighResolution RP-18e	2 and 4.6 mm I.D. and Capillary columns
HighResolution RP-8e	4.6 mm I.D. and Capillary columns
RP-18e	2, 3, 4.6, 10, 25 mm I.D. and Capillary columns
RP-8e	4.6 mm I.D.
CN	4.6 mm I.D.
Diol	4.6 mm I.D.
NH ₂	4.6 mm I.D.
Si	4.6, 10 and 25 mm I.D.

Chromolith® WP 300 Columns for Biomolecule separation

Chromolith® columns have shown great potential for the analysis of proteins, antibodies and large peptides where columns with good permeability, along with better mass transfer and selectivity are required. Chromolith® columns remove back pressure as the primary consideration in method development and allow flow rate flexibility for much higher throughput, a choice of column lengths for superior resolution, and more solvent options for optimum selectivity. With no individual particles to shift or break, column performance is consistent over a much longer lifetime, making them ideal for matrix-rich sample analysis.

	Column Dimensions
WP 300 RP-18	2 and 4.6 mm I.D.
WP 300 RP-8	4.6 mm I.D.
WP 300 RP-4	4.6 mm I.D.
WP 300 Protein A	2 and 4.6 mm I.D.
WP 300 Epoxy	2 and 4.6 mm I.D.

Monolithic Silica Technology

Chromolith® HPLC and UHPLC Columns

Chromolith® WP 300 HPLC Columns

Analysis speed

Chromolith® columns owe their rapid separation speed to their unique bimodal pore structure of macro and mesopores. The macropores reduce column back pressure and allow the use of faster flow rates, thereby considerably reducing analysis time. The mesopores form a fine porous structure, which creates a very large, active surface area for high-efficiency separations.

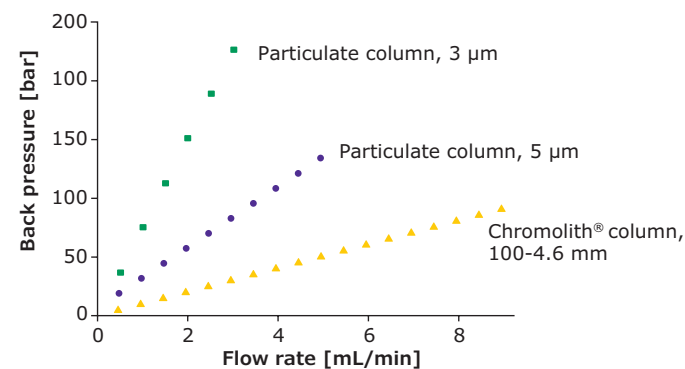

With Chromolith® columns, flow rates can now easily be varied from 1 mL up to 9 mL per minute with the same high quality resolution. A mixture of five beta-blocker drugs was analyzed to demonstrate the extreme time savings and high separation efficiency made possible with Chromolith® columns. Due to excellent mass transfer properties of the monolithic skeleton, high-speed separation was possible, even at high flow rates. The beta-blockers were well separated with excellent peak symmetry. At 9 mL/min, analysis time was less than 1 minute, and the column back pressure was only 153 bar.

High separation efficiency

The traditional plate-count method of measuring quality shows that the separation efficiency of Chromolith® columns is better than standard 5 µm particulate columns, and just as good as 3.5 µm columns, but with the ability to continue up to 9 mL/min without reaching HPLC system pressure limits. The van Deemter plot of the Chromolith® column clearly demonstrates that separation efficiency does not decrease significantly when flow rate is increased, as is the case with particulate columns. It is therefore possible to operate Chromolith® columns at high flow rates with minimal loss of peak resolution. For complex separations, it is still necessary to use long columns in order to provide the separation efficiency required for resolution of all compounds of interest. Chromolith® HPLC columns can be connected in series to produce a column with high plate count at low back pressure. (Please see: Chromolith® column coupler). With particulate columns, further column length is prevented by excessive back pressure.

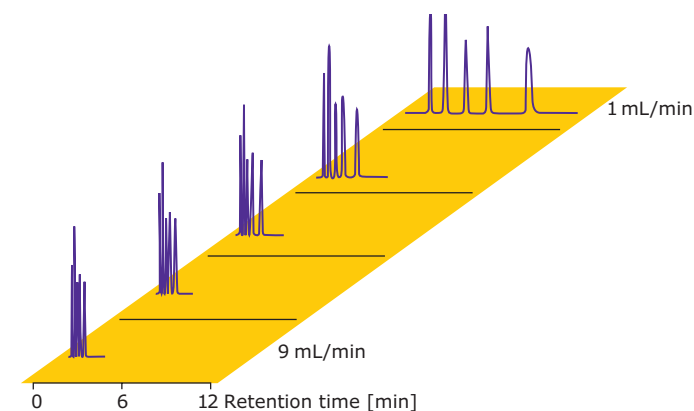

Chromolith® Performance RP-18e 100-4.6 mm

Column:	Chromolith® Performance RP-18 endcapped 100-4.6 mm	
Mobile phase:	Isocratic acetonitrile / 0.1 % trifluoroacetic acid in water, 20/80 (v/v)	
Pressure:	Total pressure (including HPLC system) 25 °C	
Detection:	UV 220 nm	
Injection volume:	5 µL	
Sample:	Atenolol	63 µg/mL
	Pindolol	29 µg/mL
	Metoprolol	108 µg/mL
	Celiprolol	104 µg/mL
	Bisoprolol	208 µg/mL

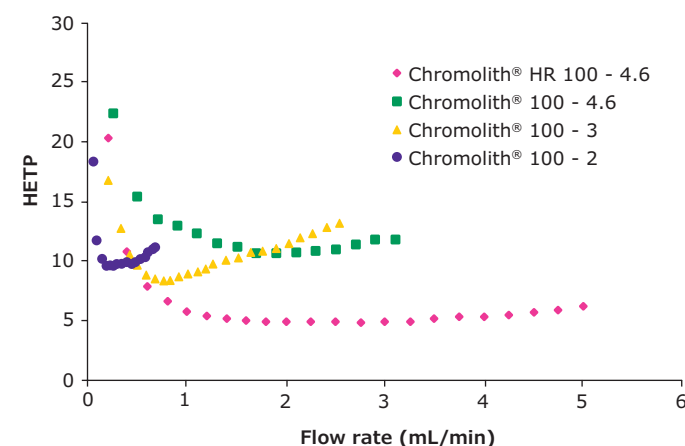

Long-term stability

Besides lower back pressure and greater flow rate flexibility, Chromolith® columns also achieve faster equilibration after gradient elution than particulate columns of similar dimensions. These features allow high-throughput analysis without loss of separation efficiency or peak capacity.

The significantly longer column lifetime of Chromolith® monolithic HPLC columns, in comparison to particulate HPLC columns, is over-compensating the higher cost of this column material in comparison to particulate columns. In particular, if matrix-rich samples are used with simplified sample preparation. Therefore, the cost per sample can be significantly lower in direct comparison under equal conditions and the same sample.

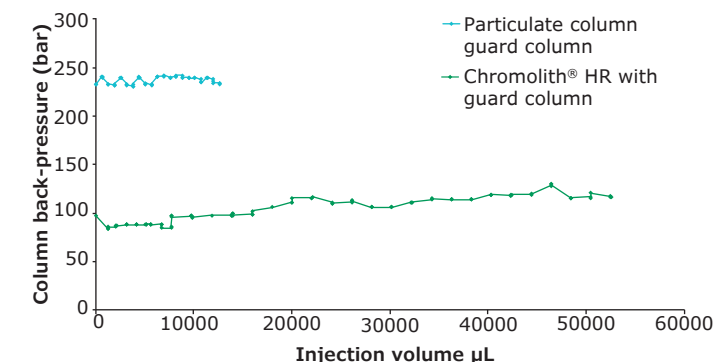

Column robustness

Chromolith® columns offer excellent robustness and unsurpassed column lifetime. This trait not only ensures maximum reliability and versatility, but also minimizes maintenance on the HPLC system. As a result, Chromolith® columns reduce cost per analysis while enhancing data integrity.

When analyzing challenging, matrix-rich samples with traditional HPLC, the benefit of monolithic silica columns is significant. Sample preparation is time-consuming and costly. The transfer from particulate columns to monolithic columns can, therefore, save a substantial amount of cost and time.

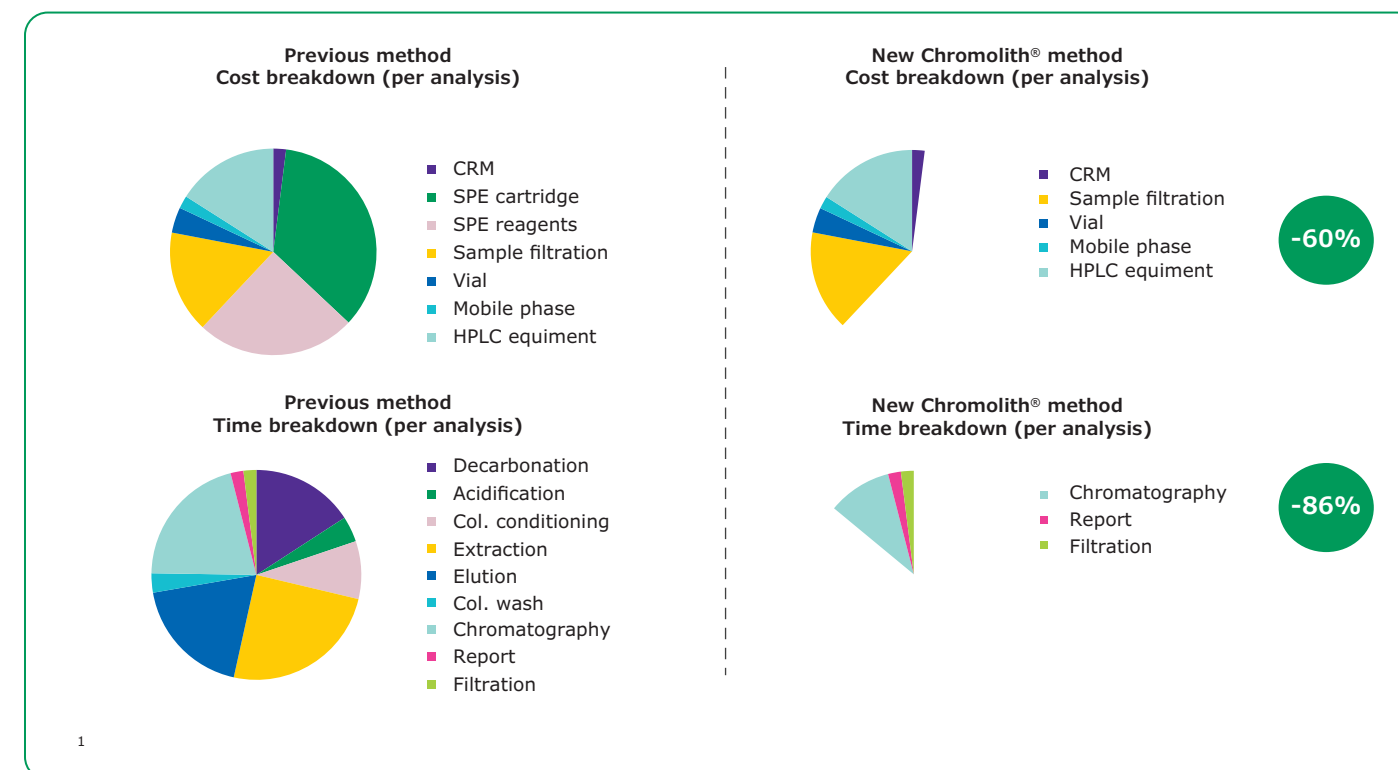

Time and cost per analysis for the determination of Iso-alpha-acids in Beer using a particulate and a monolithic column.

Chromolith® and Chromolith® HR HPLC Columns

Robust and rapid separation of small molecules

Chromolith® Performance HPLC columns provide the highest matrix-tolerance due to their large macropores (2 µm) and are available with several column chemistries for a broad selectivity range.

Chromolith® columns with 2 mm internal diameter are ideal for use with UHPLC or UPLC® instruments, thanks to their very small internal volumes. A particular benefit is the very fast analysis, reduced sample-preparation and the low column backpressure. Ultra-high performance and extremely low operating pressure make Chromolith® 2 mm columns truly unique.

Excellent, ultra-fast results are obtained, not only in UHPLC and UPLC® instruments, but equally well in all standard HPLC systems with low dead volume. Chromolith® 2 mm columns have macropores of 1.5 µm in diameter, resulting in a column efficiency that exceeds 100,000 plates/meter.

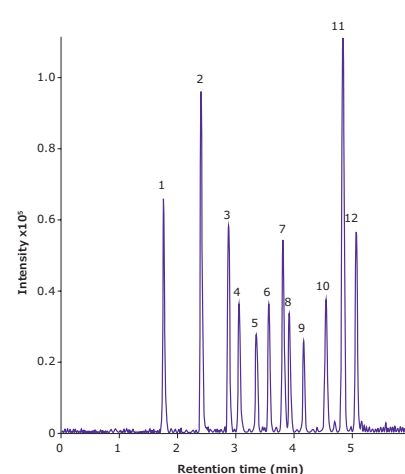

Column:	Chromolith® FastGradient RP-18 endcapped 50-2 mm		
Mobile phase:	A: ACN + 0.1 % HCOOH		
phase:	B: Water + 0.1 % HCOOH		
Gradient:	Time	% A	% B
	0	15	85
	4.5	70	30
	6	70	30
Flow rate:	0.5 mL/min		
Pressure:	55 – 85 bar		
Detection:	MS; Ion Source: ESI; Ion Trap		
Sample:	1. Metabolite of Fluoxymesterone	353 m/z	
	2. Metabolite of Stanozolol	345 m/z	
	3. Metabolite of Danazol	343 m/z	
	4. Testosterone	289 m/z	
	5. Epitestosterone	289 m/z	
	6. Metabolite of Methyltestosterone	271 m/z	
	7. Metabolite of Calusterone	285 m/z	
	8. Metabolite of Clostebol	305 m/z	
	9. Boldenone-acetate	329 m/z	
	10. Testosterone-acetate	331 m/z	
	11. Nandrolone-17-Propionate	331 m/z	
	12. Testosterone-Propionate	345 m/z	

Phase Bonding	USP Designation	Bonding Chemistry	Silica Type	Macropore Size (µm)	Mesopore Size (Å)	Pore volume (mL/g)	Surface Area (m²/g)	Carbon Load (%)	pH Stability	Max Temperature	Endcapped
RP-18 endcapped	L1	Octadecylsilane	Monolithic Type B silica	2 [2 mm I.D. Columns: 1.5 µm]	130	1	300	18	2 - 7.5	50	Yes
High Resolution RP-18 endcapped	L1	Octadecylsilane	Monolithic Type B silica	1.15	150	1	250	18	1.5 - 8	50	Yes
RP-8 endcapped	L7	Octylsilane	Monolithic Type B silica	2	130	1	300	11	2 - 7.5	50	Yes
High Resolution RP-8 endcapped	L7	Octylsilane	Monolithic Type B silica	1.15	150	1	300	11	1.5 - 8	50	Yes
CN	L10	Cyanosilane	Monolithic Type B silica	2	130	1	300	6	2 - 7.5	50	No
Diol	L20	Diolsilane	Monolithic Type B silica	2	130	1	300	9	2 - 7.5	50	No
NH2	L8	Aminopropylsilane	Monolithic Type B silica	2	130	1	300	5	2 - 7.5	50	No
Si	L3	unbonded	Monolithic Type B silica	2	130	1	300	n.a.	2 - 7.5	50	No

Chromolith HPLC Columns

Chromolith® HighResolution (HR) columns have around 50% higher efficiency, which is approximately equivalent to 2.6 µm particulate columns, whereas the backpressure is approximately equivalent to 5 µm columns, excellent peak symmetry and still more than 30 % longer lifetime compared with particulate columns. Two Chromolith® HighResolution columns could be easily coupled in order to achieve even higher resolution. The completely endcapped stationary phase enables peak-tailing free elution of basic compounds.

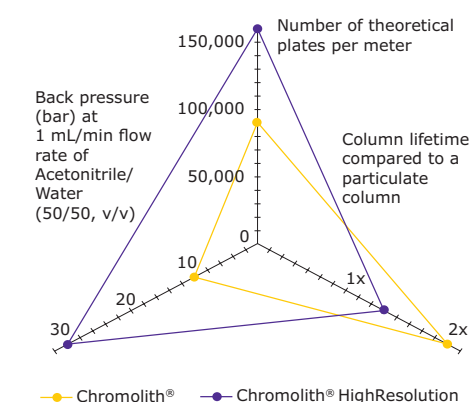

Excellent batch-to-batch reproducibility

The batch-to-batch reproducibility of Chromolith® HPLC columns is strictly controlled and fulfills the requirements of QA and QC laboratories.

Chromolith® Performance RP-18e 100-4.6 mm

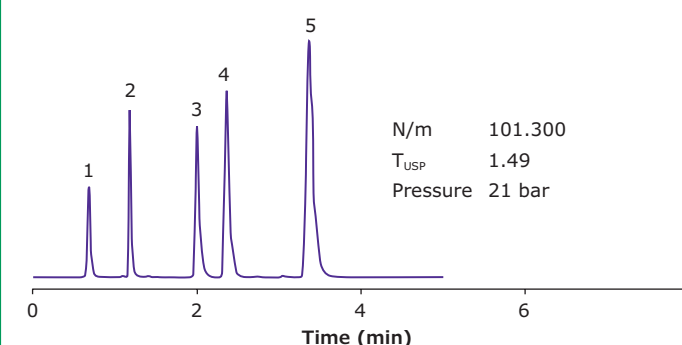

Mobile phase:	Acetonitrile / water 60/40
Flow rate:	2 mL/min
Detection:	UV 254 nm
Temperature:	ambient
Injection volume:	5 µL
Sample:	1. Urea 2. Biphenyl-2-ol 3. Progesterone 4. Hexanophenon 5. Anthracene

Chromolith® HR RP-18e 100-4.6 mm

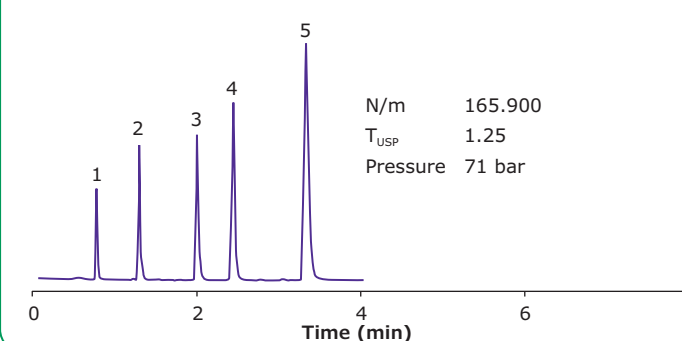

Chromolith® HighResolution RP-18e 100-4.6 mm

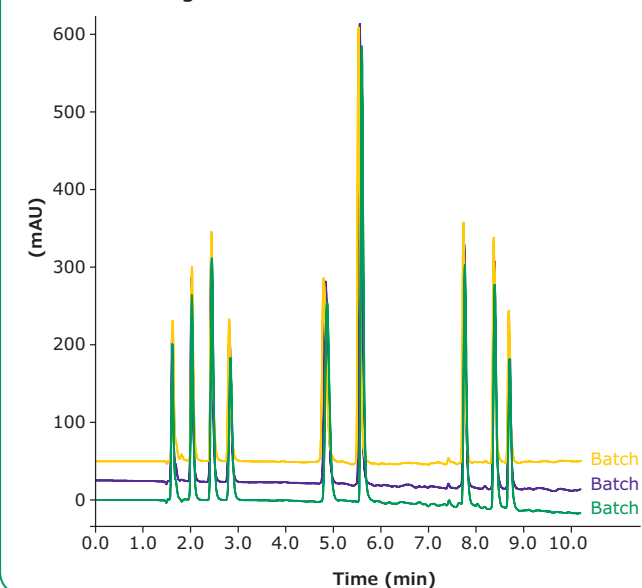

Column:	Chromolith® HighResolution RP-18 endcapped 100-4.6 mm
Mobile phase:	A: Acetonitrile + 0.1 % TFA B: Water + 0.1 % TFA
Gradient:	2 min 0% A 10 min 30% A
Flow rate:	1 mL/min
Detection:	UV 210 nm
Temperature:	25°C
Injection volume:	2 µL
Sample:	1. Norepinephrine 2. Octopamine 3. Epinephrine tartrate 4. Dopamine 5. DOPA 6. Norephedrine 7. Ephedrine 8. N-Methylephedrine

Chromolith® Semi-preparative and Preparative HPLC Columns

Chromolith® SemiPrep 10 mm I.D. columns

Combine high separation speed with excellent performance. These traits make them the perfect alternative to particulate columns of 10 mm I.D. (and even 21.2 mm I.D.). These columns have the same bimodal porous silica rod structure as Chromolith® analytical columns with an internal diameter of 4.6 mm. Their macropores are 2 µm in diameter and the mesopores are 13 nm. This combination dramatically reduces separation time while increasing efficiency.

Chromolith® Prep columns

Preparative HPLC involves much higher sample volumes than analytical chromatography. Consequently, greater sample throughput and separation speed are essential for optimal productivity. These criteria are best fulfilled by Chromolith® Prep columns. The combination of macro and mesopores maximizes separation efficiency and flow rate, while minimizing resistance.



Ready-to-use Chromolith® Prep column

Ordering Information

Column dimension									
Length (mm)	I.D. (mm)	RP-18e	HR RP-18e	RP-8e	HR RP-8e	CN	Diol	NH2	Si
25	x 4.6	1.51463.0001	1.52020.0001			1.52046.0001	1.53170.0001	1.52026.0001	
25	x 3	1.52003.0001							
25	x 2	1.52014.0001	1.52320.0001						
50	x 4.6	1.51450.0001	1.52021.0001			1.52047.0001	1.53171.0001	1.52027.0001	
50	x 3	1.52002.0001							
50	x 2	1.52007.0001	1.52321.0001						
100	x 4.6	1.02129.0001	1.52022.0001	1.51468.0001	1.52064.0001	1.52048.0001	1.53172.0001	1.52028.0001	1.51465.0001
100	x 3	1.52001.0001							
100	x 2	1.52006.0001	1.52322.0001						
150	x 4.6		1.52023.0001						
100	x 10	1.52016.0001							1.52015.0001
100	x 25	1.25252.0001							1.25251.0001
Validation Kits [3 Chromolith® HPLC cartridges from 3 different sorbent batches]									
50	x 2	1.52062.0001							
100	x 4.6	1.51466.0001	1.52019.0001						
100	x 3	1.52063.0001							
10	x 10	1.52036.0001							1.52035.0001
Chromolith® Guard cartridges [3 units]									
5	x 4.6	1.51451.0001	1.52025.0001	1.52013.0001		1.52050.0001	1.53175.0001	1.52030.0001	1.52011.0001
10	x 4.6	1.51452.0001							
5	x 3	1.52005.0001							
5	x 2	1.52009.0001	1.52325.0001						
Chromolith® Guard cartridges Set [1 starter kit with holder and 3 guard cartridges]									
5	x 4.6	1.52008.0001							
5	x 3	1.52004.0001							

 Validation kits are available

Chromolith® Guard Column Holder

Chromolith® HPLC guard cartridges are extremely easy to use. The guard cartridges are simply added directly in front of the main column to protect it from chemical or mechanical contamination. Due to the benefits of monolithic technology, and the convenience of Chromolith® guard columns, they are also popular for use with classical particulate columns. Moreover, guard columns can be used as trap columns when large sample volumes are to be injected. Guard columns should be changed frequently in order to avoid excessive accumulation of impurities.

Guard cartridge holders

Depending on your needs, we offer several different guard cartridge holders: made out of PEEK for 2 and 3 mm I.D. cartridges; bioinert PEEK lined stainless steel holder and standard stainless steel holder for 4.6 mm I.D. cartridges and holders for 10 and 25 mm I.D. cartridges.

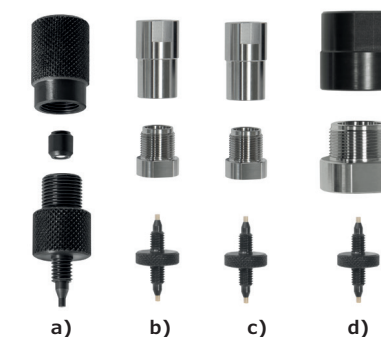

Guard cartridge holder type	Material holder is made of	Max. back pressure	How to tighten holder	Guard cartridge I.D.	Guard cartridge length
a)	PEEK	200 bar (2,940 psi)	Finger-tight	2, 3 mm	5 mm
b)	PEEK lined SS	400 bar (5,880 psi)	Finger-tight + tool (not included)	4.6 mm	5 mm
c)	SS	400 bar (5,880 psi)	Finger-tight + tool (not included)	4.6 mm	5 mm, 10 mm
d)	PEEK / SS	150 bar (2,205 psi)	Finger-tight + tool (not included)	10 mm	10 mm

Ordering Information

Chromolith® Guard cartridge holder			
for dimension	Type	Material	Item No.
5 x 2 and 3	a	PEEK	1.52004.0001
5 x 4.6	b	Bioinert	1.52255.0001
5 x 4.6	c	SST	1.52032.0001
10 x 4.6	c	SST	1.52033.0001
10 x 10	d	PEEK/SST	1.52037.0001

Chromolith® Column Coupler Make your column longer for extra high resolution

The Chromolith® HPLC column coupler is designed for linking several monolithic columns together in order to further increase separation efficiency and column performance. The combination results in a theoretical plate count that is significantly higher than any particulate column available. At the same time, pressure is kept well below the HPLC system limit.



Ordering Information

Chromolith® Column coupler	
for analytical columns	1.51467.0001
for 25 mm I.D. columns	1.25259.0001

Chromolith® WP 300

Monolithic HPLC Columns for Biomolecule Separation

Biotherapeutics, for example bio-engineered drugs and peptide therapeutics, represent the promise of new medical treatments for the future. Production costs have been falling, leading to an extremely high demand for suitable analytical methods for process monitoring and quality control of these biomolecules. HPLC is the preferred method of analysis, and it is important to use the right column for these larger molecules.

Accurate analysis of proteins, antibodies and large peptides requires columns with good permeability, along with better mass transfer and selectivity. In order for size-exclusion not to influence the separation, the pore size should be approximately ten-times larger than the molecule being analyzed.

In contrast to conventional packed-particle columns, wide pore (300 Å) monolithic silica columns are made of a single continuous-bed rod of high purity porous silica that is then bonded with C18, C8, C4, epoxy and Protein A depending on the use of the column.

Monolithic columns remove backpressure as the primary consideration in method development and allow:

- Flow rate flexibility for much higher throughput
- Choice of column lengths for superior resolution
- More solvent options for optimum selectivity

With no individual particles to shift or break, column performance is consistent over a much longer lifetime, making them ideal for relatively "dirty or matrix-rich" sample analysis. High permeability also makes them very forgiving of less rigorously prepared samples, in addition to making it easier to aggressively flush out for re-equilibration.

Features and Benefits

- Completely bioinert column hardware
- High biorecovery
- Selectivity for a range of biomolecules
- Very low column backpressure
- High-speed separation possible
- Longer column lifetime
- High resistance to column blockage
- Cost savings from higher sample throughput and column durability
- Possibility to use flow gradients

Fast chromatography with low column back pressure

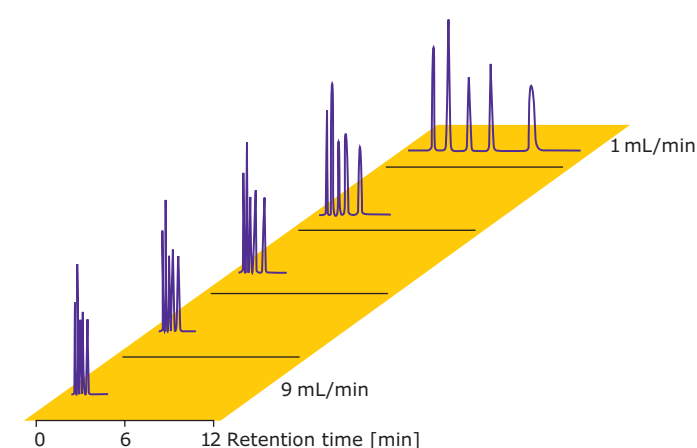

Owing to the very high porosity of the Chromolith® WP 300 column, very high flow rates can be applied with very low pressures as seen above.

A mixture of five compounds demonstrates the extreme time savings and high separation efficiency made possible with Chromolith® WP 300 columns. Due to excellent mass transfer properties of the monolithic skeleton, high-speed separation is possible even at high flow rate.

Chromolith® WP 300

Chromolith® WP 300 Protein A – Fast monoclonal antibody quantitation

Affinity chromatography is a selective technique which takes advantage of specific molecular interactions, for example antigen and antibody. The Chromolith® WP 300 Protein A HPLC column is designed to monitor monoclonal antibody titer and yield determination from cell-culture supernatants. The analytical scale procedure helps to monitor the titer of monoclonal

antibody for the optimal time for harvest of the monoclonal antibody products. Chromolith® WP 300 Protein A column could be used for separation of all IgGs (except class 3). Columns provide extremely fast separations and could be used longer minimizing overall analysis costs.

Monoclonal Antibody Analysis

Eluent A	100 mM sodium phosphate pH 7.4		
Eluent B	100 mM sodium phosphate pH 2.5		
Flow rate	2.0 mL/min		
Detection	280 nm		
Temperature	25 °C		
Injection volume	10 µL		
Gradient	Time	%A	%B
	0.00	100	0
	0.25	100	0
	0.26	0	100
	1.25	0	100
	1.26	100	0
	2.50	100	0

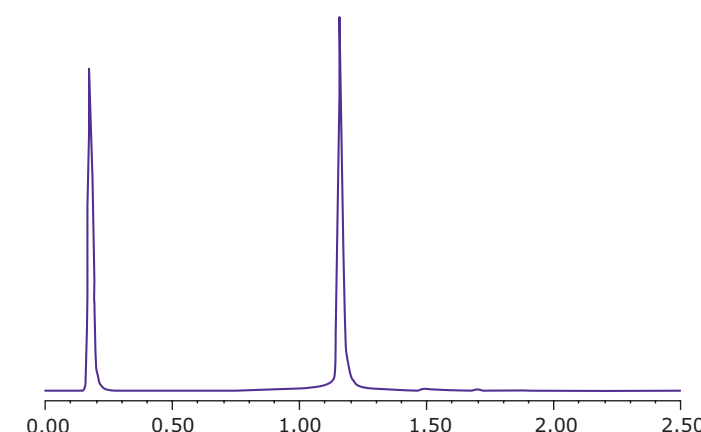

Linearity

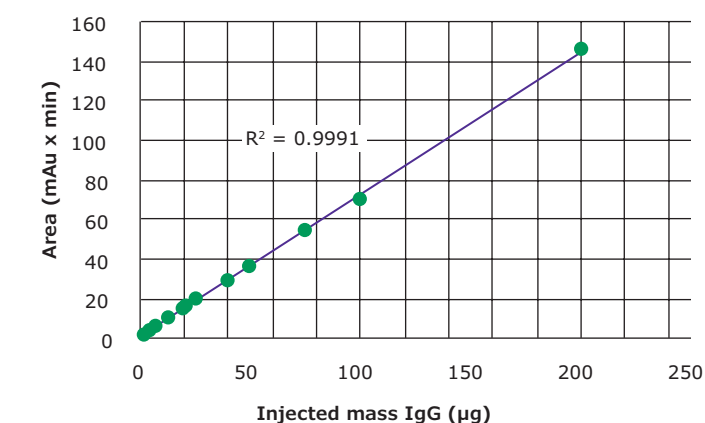
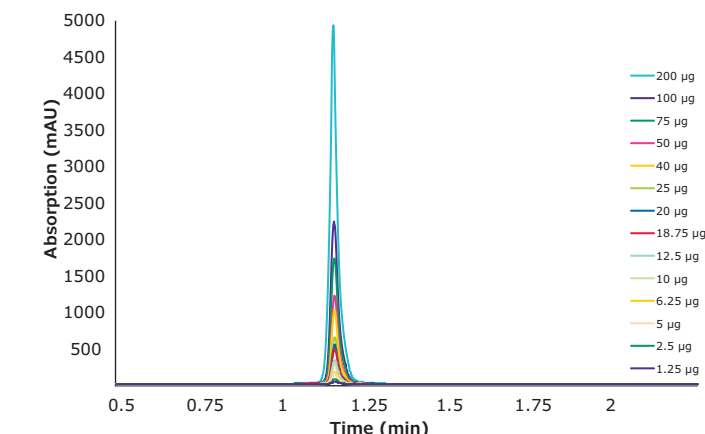

Constant binding efficiency at any flow rate

- High-speed separation at high flow rate due to excellent mass transfer properties of the monolithic skeleton
- Separation of IgG demonstrates the extreme time savings and high separation efficiency made possible with Chromolith® Protein A columns.
- IgG was well separated with excellent peak symmetry
- At 5 mL/min, the total analysis time is less than 1 minute and the net column backpressure is only 21 bar
- Antibody binding is not affected by flow rate
- As depicted at right, antibody capture and release is very reproducible across 50 injections

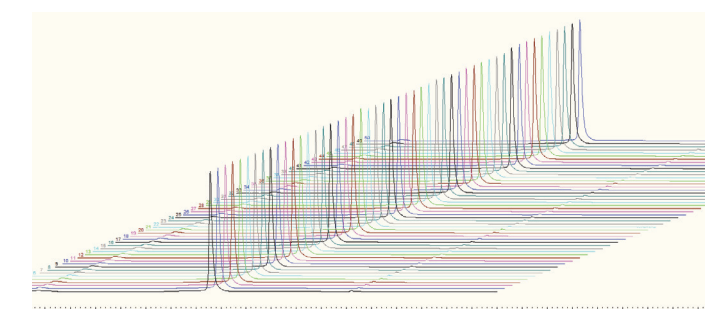

Parameter	RSD
Retention time	< 0.1%
Peak Height	< 0.9%
Peak area	< 0.5%

Chromolith® WP 300 Epoxy

Create your own column selectivity on demand

Chromolith® WP 300 Epoxy columns are specially designed for the user-specific immobilization of ligands and their later application in HPLC. The unique bimodal pore structure of silica monoliths allows efficient coupling independent of molecule size. The wider mesopores also enable the use of both proteins and antibodies as ligands immobilized on the column, and as analytes separated by an immobilized column.

Immobilization via epoxide functions

Step I - Equilibration

Column equilibration with 50 mL 50 mM sodium phosphate + 1.9 M ammonium sulfate pH 8.0

2.0 mL/min flow rate at room temperature

Step II - Immobilization

Dissolving of ligand in 25 mL 50 mM sodium phosphate + 1.9 M ammonium sulfate pH 8.0

Connection of ligand solution to pump

Immobilization in cycles with 0.2 mL/min flow rate at room temperature for 4 – 24 h

Step III - Quenching & washing

Quenching of remaining epoxide functions with 150 mM phosphoric acid or 1 M glycine (optional)

Washing of the immobilized column with 100 mM sodium phosphate pH 7.4

After immobilization, the column is ready to use for the desired purpose of the immobilized ligand. The type of required solvent or buffers depends on the type of ligand used. Chromolith® WP Epoxy columns can be used with all commonly used HPLC grade organic solvents, with the following restrictions. The mobile phase should NOT contain more than 50% Tetrahydrofuran (THF), 5% Chlorinated solvent (e.g. Dichloromethane) or 5% Dimethylsulfoxide

Potential applications: Attach trypsin to obtain HPLC column-protein digestion reactor, attach a protein for protein-protein interaction analysis, attach any chiral selector to obtain a chiral column, or attach any affinity ligand for a custom made affinity column, among other options.

The Chromolith® WP 300 Epoxy column is shipped in 100% 2-Propanol. The column has to be washed with 20 CV deionized water before immobilization.

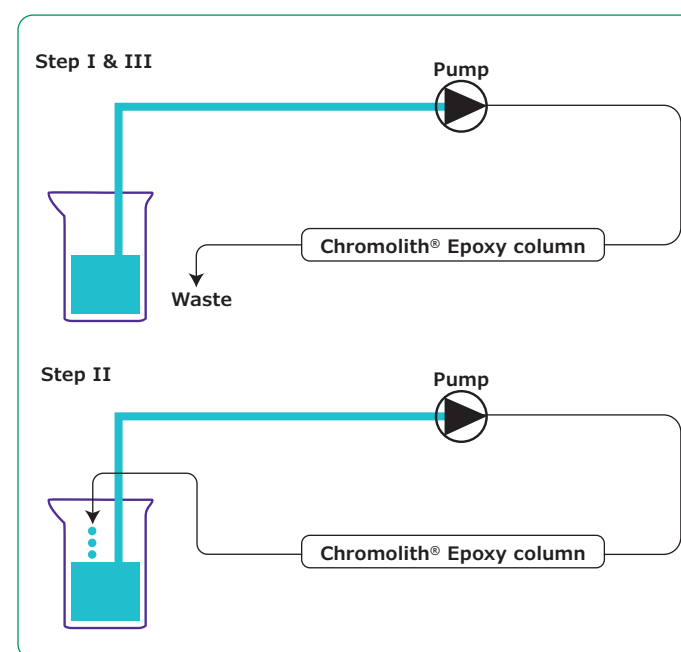

(DMSO). However pure DMSO can be used as solvent for samples. Buffers, organic modifiers and ion pair reagents present no problems as long as the appropriate pH range is not exceeded. Nevertheless, be careful not to expose the column to conditions which could cause denaturation of the ligand.

Affinity Column created by immobilization of concanavalin A onto Chromolith® Epoxy

Preparing the Column:

Immobilization according to Epoxy method using a Chromolith® WP 300 Epoxy 100-4.6 mm column with 50 mg concanavalin A from Jack bean dissolved in 25 mL 50 mM disodium hydrogen phosphate, 1 mM calcium chloride + 1.9 M ammonium sulfate, pH 8.0. Immobilization for 4 hours at 0.2 mL/min and quenching of remaining epoxide functions with glycine.

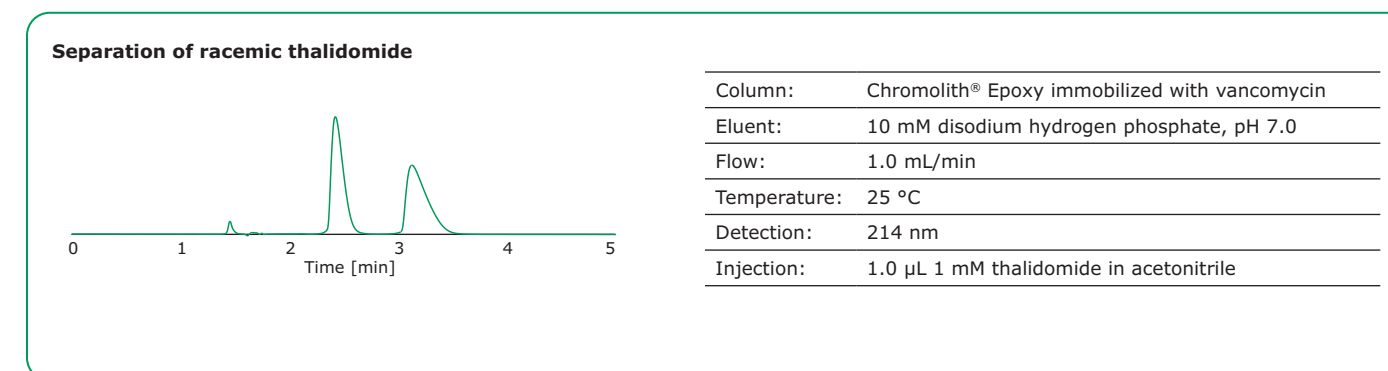
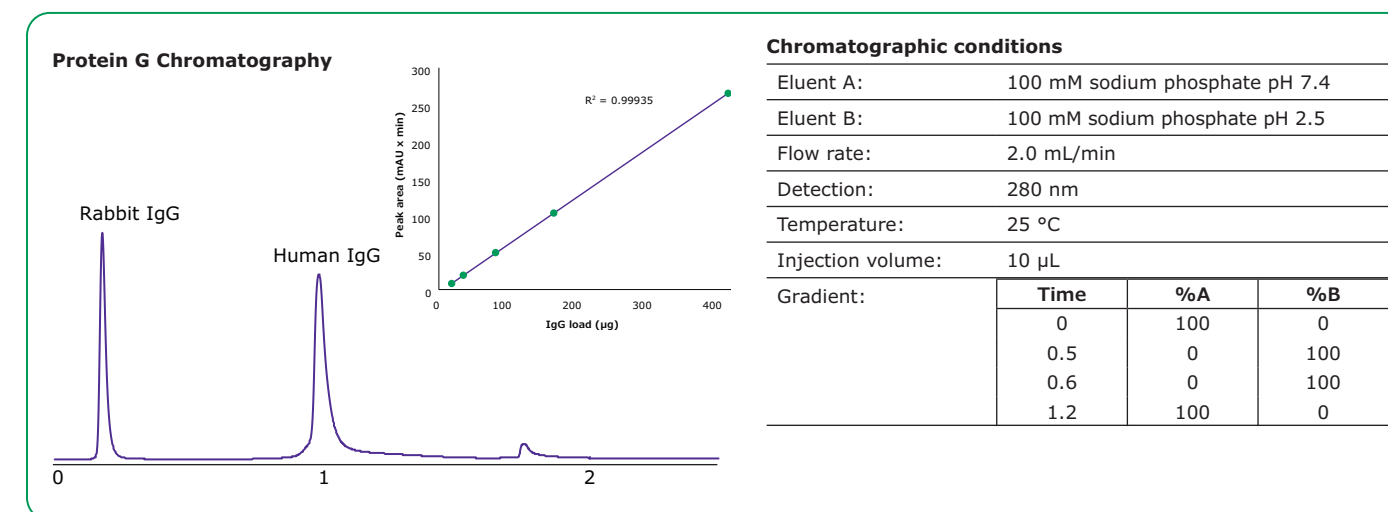
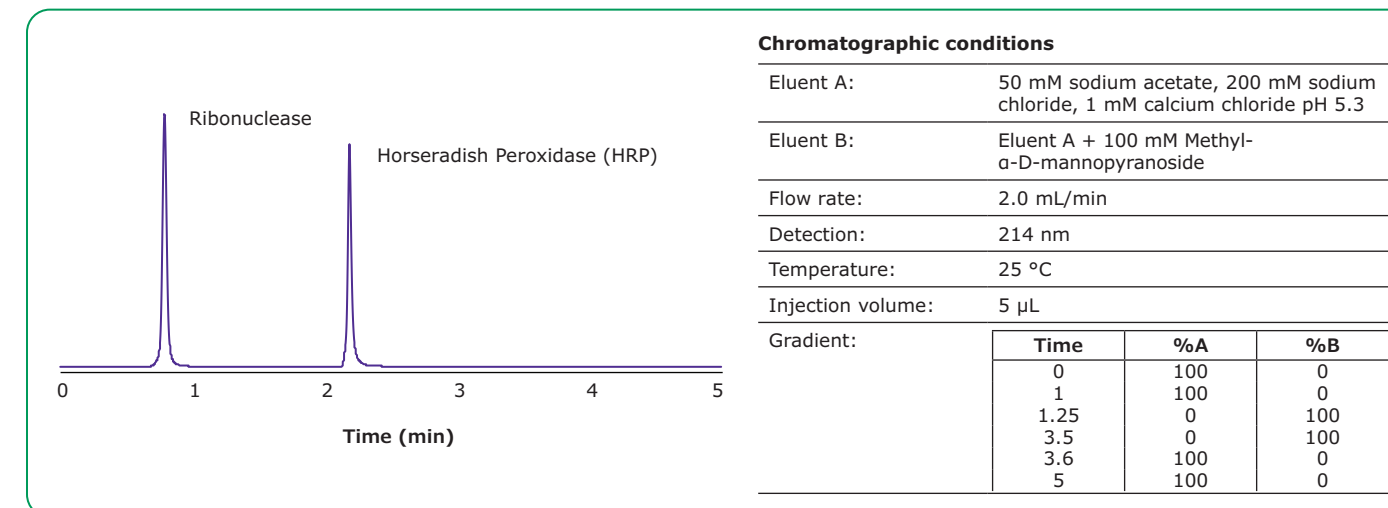

Chromolith® WP 300 HPLC Columns

Chromolith® WP 300 RP-18, RP-8 and RP-4: reversed-phase HPLC columns for bioapplications

Reversed-phase chromatography is often used for protein and peptide separations. The longer octadecyl (C18) chains can efficiently separate complex peptide mixtures; shorter C8 modified columns are used for small, less hydrophobic proteins; C4 is mainly applied for separation of hydrophobic proteins.

Separation of five peptides using Chromolith® WP 300 RP-18

Column:	Chromolith® WP 300 RP18 100 x 4.6 mm
Mobile phase:	A: Water 0.1% TFA B: Acetonitrile 0.1% TFA
Flow rate:	1.0 mL/min
Detection:	220 nm
Temperature:	60 °C
Injection volume:	1.0 µL
Sample:	HPLC peptide standard mixture (Sigma, H2016)

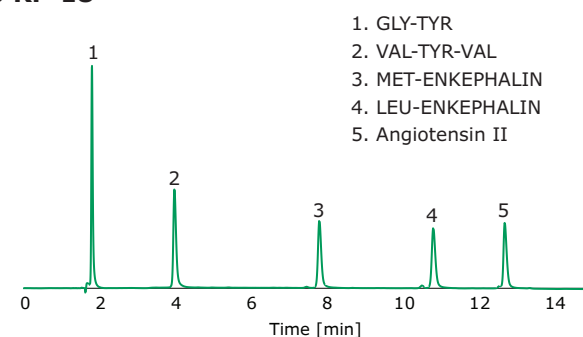

1. GLY-TYR
2. VAL-TYR-VAL
3. MET-ENKEPHALIN
4. LEU-ENKEPHALIN
5. Angiotensin II

Chromolith® WP 300 Specifications

Phase Bonding	USP Designation	Bonding Chemistry	Silica Type	Macropore Size (µm)	Mesopore Size (Å)	Pore volume (mL/g)	Surface Area (m ² /g)	Carbon Load (%)	pH Stability	Max Temperature	Endcapped
RP-18	L1	Octadecylsilane	Monolithic Type B silica	2	130	1	300	8-9	2 - 7.5	60	No
RP-8	L7	Octylsilane	Monolithic Type B silica	2	130	1	300	4-5	2 - 7.5	60	No
RP-4	L26	Butylsilane	Monolithic Type B silica	2	130	1	300	3-4	2 - 7.5	60	No
Protein A		Protein A	Monolithic Type B silica	2	130	1	300	n.a.	2 - 7.5	45	No
Epoxy		Glycidoxipropylsilane	Monolithic Type B silica	2	130	1	300	5-6	2 - 7.5	60	No

Ordering Information

Column dimension						
Length (mm)	I.D. (mm)	RP-18	RP-8	RP-4	Protein A	Epoxy
Chromolith® WP 300 HPLC Column [1 unit]						
25	x 4.6				1.52258.0001	1.52252.0001
25	x 2				1.52358.0001	1.52352.0001
50	x 4.6	1.52271.0001	1.52266.0001	1.52261.0001		1.52251.0001
50	x 2	1.52371.0001				1.52351.0001
100	x 4.6	1.52270.0001	1.52265.0001	1.52260.0001		1.52250.0001
100	x 2	1.52370.0001				1.52350.0001
Chromolith® Guard cartridges [3 units]						
5	x 4.6	1.52273.0001	1.52268.0001	1.52263.0001		1.52254.0001
5	x 2	1.52372.0001				1.52353.0001
10	x 4.6	1.52272.0001	1.52267.0001	1.52262.0001		1.52253.0001
Chromolith® Guard cartridges Holder						
5	x 4.6	1.52032.0001				
10	x 4.6	1.52033.0001				
Chromolith® Column coupler						
		1.51467.0001				

Chromolith® CapRod® Capillary Columns

A Chromolith® CapRod® capillary column combines the speed of monolithic silica technology with the sensitivity of nano-LC. These traits enable superior productivity for high throughput, highly sensitive proteomics-LC applications. Compared to particulate capillary columns, Chromolith® CapRod® capillaries demonstrate better performance with optimal resolution (narrow peak widths), increased productivity (higher sample throughput), and extended column lifetime. Furthermore, column length is less limited than with any other type of column. The capillaries can even be slightly bent to fit any LC configuration or instrument. Chromolith® CapRod® columns are designed to work

with various nano or capillary-LC systems. This trait provides the highest efficiency and performance when coupled to mass spectrometers, both on-line (ESI, nanospray) and off-line (MALDI). Compared to classical micro-particulate sorbents, Chromolith® CapRod® columns can be operated at higher flow rates—without loss of performance, resolution, or limitations due to column back pressure. Separations can be achieved at 1–3 µL/min, compared to 200–400 nL/min for conventional media on a standard 100 µm LC capillary column. For more complex, biological samples, a trapping capillary can be used to protect the separation column and optimize separation efficiency.



Recommended use and flow rate ranges

Recommended use	RP-18e 150 x 0.05 mm	RP-8e 150 x 0.1 mm	RP-18e 50 x 0.1 mm Trap	RP-18e 150 x 0.1 mm	RP-18e 300 x 0.1 mm	RP-18e 150 x 0.1 mm HR	RP-18e 50 x 0.2 mm Trap	RP-18e 150 x 0.2 mm	RP-18e 150 x 0.2 mm HR
Separation of small molecules	•		•	•	•	•	•	•	•
– of peptides	•	•	•	•	•	•	•	•	•
– of proteins		•							
Micro ESI		•		•	•	•		•	•
Nano ESI	•	•		•	•	•			•
High Resolution						•			•
Flow rates (µL/min)	0.2 – 0.8	0.4 – 3	1 – 10	0.4 – 3	0.2 – 1.5	0.1 – 0.4	10 – 50	5 – 20	0.5 – 2
Max back pressure (bar)	200	200	200	200	200	218	218	218	218

Ordering Information

Column dimension					
Length (mm)	I.D. (mm)	HR RP-18e	RP-18e	RP-8e	
Chromolith®CapRod® HPLC capillary columns [1 unit]					
50	x 0.1	Trap		1.50426.0001	
50	x 0.2	Trap		1.50409.0001	
150	x 0.05			1.50403.0001	
150	x 0.1		1.50404.0001	1.50402.0001	1.50400.0001
150	x 0.2		1.50407.0001	1.50405.0001	
300	x 0.1			1.50424.0001	

Fully Porous Particulate Silica (FPP) Columns

High Loadability and scalable from Nano LC to Preparative LC

Fully porous silica particles (FPP) are well established in the chromatographic community over the past several decades. These columns are in use in thousands of methods and ensure reliable results over the complete range of use, particle sizes and column dimensions in

- Nano-LC (Capillary columns)
- UHPLC
- Analytical HPLC
- Semipreparative LC
- Preparative LC

Fully porous silica particles provide the full loadability of the stationary phase due to its fully porous physical characteristics. This trait ensures high sensitivities because the peak broadening effect of overloading the stationary phase is minimized.

Traditional fully porous silica particles such as LiChrosorb®, LiChrospher®, Superspher® and SUPELCO SIL™ are based on Type A silica which is produced from sodium waterglass.

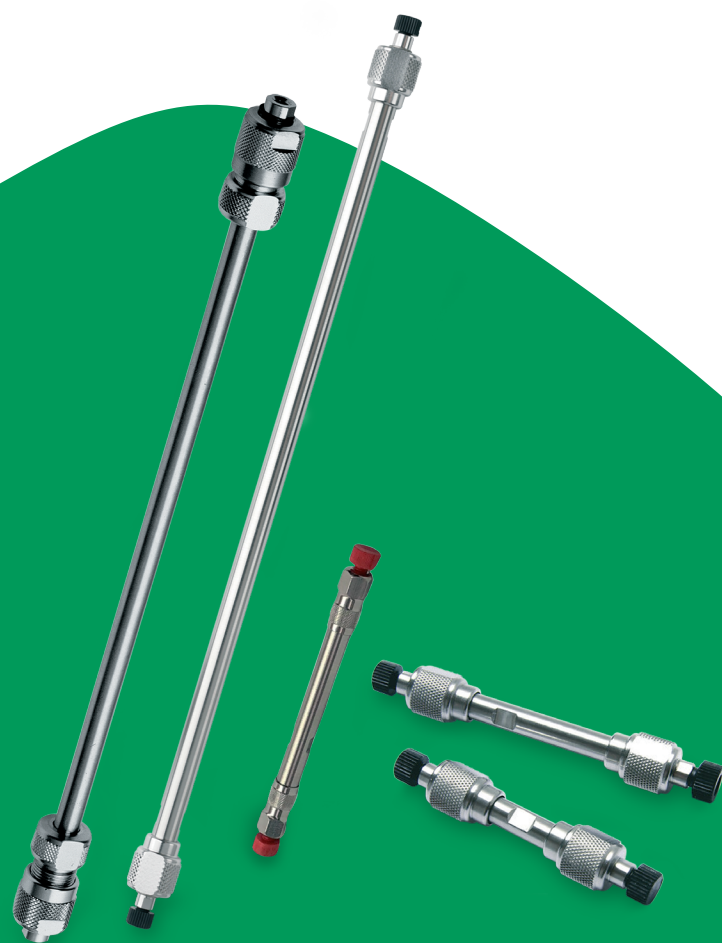

The more modern, high purity Type B silica was introduced in the early 1990's. Type B silica particles are produced from tetraalkoxysilane in a sol-gel process. This metal-free stationary phase base material can be used for the analysis of acidic, basic, and chelating compounds providing excellent peak symmetries with less need for strong buffer concentrations.

Therefore, this type of stationary phase base material is the preferred FPP option for method development, method improvement and LC-MS use.







FPP Type B stationary phases (RP and HILIC):

UHPLC (pressure stability of 1000 bar):

- [Purospher™ STAR](#) 
 - 2 µm particle size
 - superior peak symmetry
 - extended pH stability
 - Available modifications: RP-18e (C18), RP-8e (C8), Phenyl, Si
- [Titan™](#) 
 - 1.9 µm particle size
 - Monodisperse silica particles providing very high efficiency
 - Available modifications: C18

Analytical HPLC:

- [Purospher™ STAR](#) 
 - 3 µm and 5 µm particle size
 - superior peak symmetry
 - extended pH stability
 - Available modifications: RP-18e (C18), RP-8e (C8), Phenyl, NH₂, Si
- [Discovery®](#) and [Ascentis®](#) 
 - 3 µm and 5 µm particle size
 - broad range of selectivities
 - Available modifications: C18, C8, Phenyl, RP-Amide; F5 (PFP), CN, Si

- [Discovery® BIO](#) 
 - 5 µm particle size
 - 300 Å pores
 - Available modifications: C18, C8, C5
- [SeQuant® ZIC®](#) 
 - 3/3.5 µm and 5 µm particle size
 - superior separation of polar compounds
 - Available modifications: Sulfobetaine (ZIC®-HILIC), Phosphorylcholine (ZIC®-cHILIC)
 - Additional: polymeric particle (5 µm) with Sulfobetaine (ZIC®-pHILIC) for extended pH stability

Semi-Preparative/Preparative LC:

- [Ascentis® Discovery®](#) and [Discovery® BIO](#)
 - 10 µm particle size
 - Column dimensions up to 21.2 mm I.D.
- [SeQuant® ZIC®](#)
 - 5 µm particle size
 - Column dimensions up to 21.2 mm I.D.

Nano LC:

- [SeQuant® ZIC®](#)
- [Discovery® BIO](#)

Validation kits

The success of an HPLC method depends strongly on the consistent quality of the stationary phase. Long-term reproducibility is a key factor in achieving reliable results. Supelco® validation kits consists of three HPLC columns, packed with three different sorbent lots to confirm the reliability of HPLC methods and their robustness.

Purospher™ STAR HPLC and UHPLC Columns

Accuracy and precision made simple

Purospher™ STAR HPLC and UHPLC columns are based on 99.999% ultra-pure fully porous silica (Type B). These columns are designed for universal use and allow the separation of basic, neutral, and metal chelating compounds with simple mobile phases and excellent peak symmetry. These columns offer an outstanding stability from pH 1.5 to 10.5 over a wide temperature range, and suitability in up to 100% aqueous mobile phases. Plus, the columns demonstrate best all around retention characteristics, as proven by the Tanaka test. Thanks to these features, Purospher™ STAR HPLC columns allow high-throughput applications and allow maximum flexibility for use with the best chromatographic conditions for any separation including reversed phase.

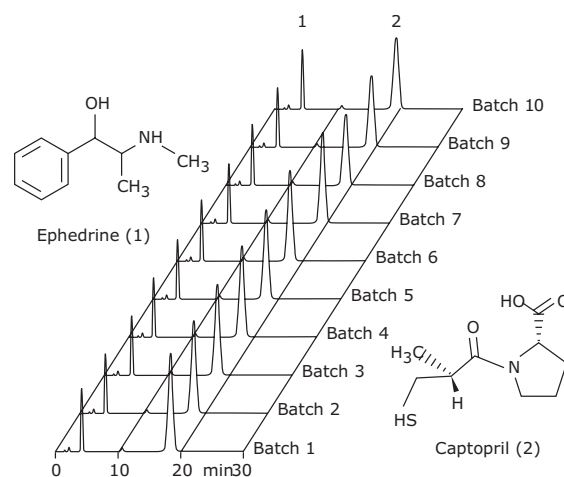

Consistent results

The success of any method depends on the quality of the stationary phase. Precise, long-term reproducibility is a key factor in achieving reliable results. The base silica of Purospher™ STAR columns is 99.999% pure. Furthermore, meticulous care is given to quality control all aspects of silica structure and chemistry. These factors ensure that the columns will always perform consistently, resulting in method reproducibility you can trust.

Features and Benefits

- Ultra-pure silica (99.999%) for excellent peak symmetry
- High separation efficiency
- Reproducible results from run-to-run and batch-to-batch
- Best overall performance according to Tanaka test
- Outstanding pH stability from pH 1.5 to 10.5
- No column dewetting when using highly aqueous mobile phases
- LC-MS compatible

Outstanding stability

The combination of extremely high purity silica, best overall retention characteristics, outstanding pH stability up to pH 10.5 and suitability for use with 100 % aqueous mobile phases makes Purospher™ STAR RP-18 endcapped an all-round top performance column, almost universal in its range of applications. The present stability test shows the suitability with 100 % aqueous mobile phase at high temperature at 60 °C.

Column:	Purospher™ STAR RP-18 endcapped, 3 µm LiChroCART® 55-4
Mobile phase:	0.1 v/v% H ₃ PO ₄ in Water
Flow rate:	1.5 mL/min
Temperature:	60 °C
Sample:	Amitriptyline Valerophenone o-Nitrophenol

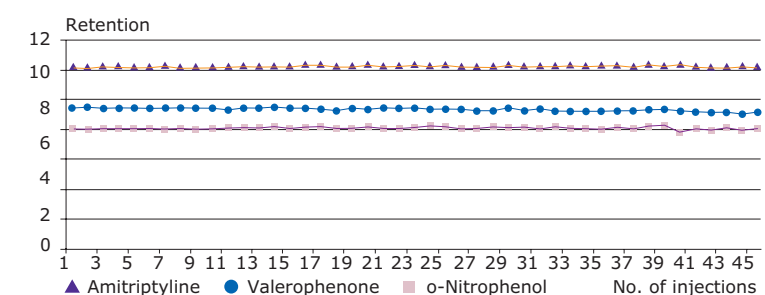
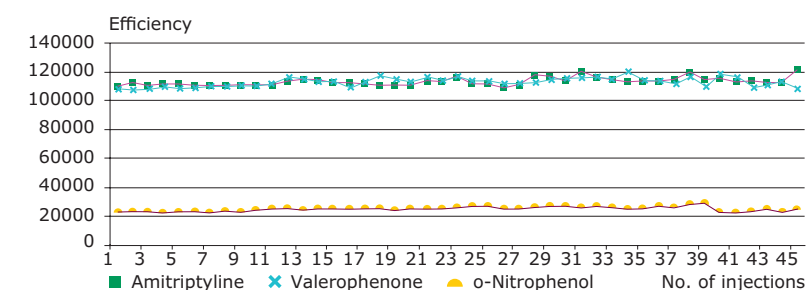

Purospher™ STAR	Phase Bonding	USP Designation	Bonding Chemistry	Chromatographic Properties / Use	Particle Size (µm)	Pore Size (Å)	Pore volume mL/g	Surface Area (m ² /g)	Carbon Load (%)	Surface coverage µmol/m ²	pH Stability	Max Temperature	Endcapped	Shipping solvent
	RP-18 endcapped	L1	Octadecylsilane with polymeric endcapping	Best in class C18 column for excellent peak symmetry, performance and pH stability. Accurate results with excellent peak shape for all types of analytes • Outstanding resolution due to high separation efficiency • Proven reliability and reproducibility from run to run and batch to batch • Universal compatibility with best all around performance according to Tanaka test • Maximum flexibility in method development and choice of mobile phase • pH stability from pH 1.5 – 10.5 • Suitable in up to 100% aqueous mobile phases • Highest sensitivity and suitability for LC-MS applications	2, 3 and 5	120	1.1	330	17	3	1.5 - 10.5	65 °C	Yes	Acetonitrile/Water
	RP-8 endcapped	L7	Octylsilane	Less hydrophobic compounds, faster retention of very hydrophobic compounds. Excellent peak symmetry for acidic, basic and chelating compounds; Excellent resolution due to high separation efficiency; Excellent stability from pH 1.5 to 10.5; Enhanced selectivity for positional isomers	2, 3 and 5	120	1.1	330	11.2	3	1.5 - 10.5	65 °C	Yes	Acetonitrile/Water
	Phenyl	L11	Phenylsilane	Enhanced selectivity for separation of aromatic compounds due to π-π interactions. • Low silanol activity • Excellent pH stability from 1.5 to 10.5 • Suitable in up to 100% aqueous mobile phases	2, 3 and 5	120	1.1	330	12.5	3	1.5 - 10.5	65 °C	Yes	Acetonitrile/Water
	NH ₂	L8	Amino	Separation of carbohydrates and polar compounds with normal-phase or HILIC chromatography. Very high separation efficiency as measured by the plate count • Absence of metal impurities, thus giving consistently symmetrical peaks • Extended column lifetime	5	120	1.1	330	3.5	3	2 - 7.5	60 °C	No	Acetonitrile/Water
	Si	L3	unbonded	Separation of polar compounds with normal-phase or HILIC chromatography Very high separation efficiency as measured by the plate count • Absence of metal impurities, thus giving consistently symmetrical peaks • Extended column lifetime	5	120	1.1	330	n.a.	n.a.	2 - 7.5	65 °C	N.A.	Acetonitrile/Water

Purospher™ STAR HPLC and UHPLC Columns

Ordering Information

Purospher™ STAR (5 µm)

Column dimension							
Length (mm)		I.D. (mm)	RP-18 endcapped	RP-8 endcapped	Phenyl	NH2	Si
LiChroCART® HPLC Cartridge [1 unit]							
100	x	2	1.50623.0001	on request	on request	on request	on request
100	x	3	1.50625.0001	on request	on request	on request	on request
100	x	4.6	1.50627.0001	on request	on request	on request	on request
125	x	2	1.50255.0001	1.50274.0001	on request	on request	on request
125	x	3	1.50253.0001	1.50038.0001	on request	on request	on request
125	x	4	1.50251.0001	1.50271.0001	on request	1.50244.0001	1.50268.0001
150	x	2	1.50624.0001	on request	on request	on request	on request
150	x	3	1.50626.0001	on request	on request	on request	on request
150	x	4.6	1.50358.0001	1.50031.0001	1.51922.0001	1.50247.0001	1.50356.0001
250	x	2	1.50256.0001	on request	on request	on request	on request
250	x	3	1.50254.0001	on request	on request	on request	on request
250	x	4	1.50252.0001	1.50272.0001	on request	1.50245.0001	1.50269.0001
250	x	4.6	1.50359.0001	1.50032.0001	1.51921.0001	1.50248.0001	1.50357.0001
250	x	10	1.50257.0001	on request	on request	on request	on request
Validation Kits [3 LiChroCART® HPLC cartridges from 3 different sorbent batches]							
125	x	4	1.50251.1003	1.50271.1003	on request	on request	on request
150	x	4.6	1.50358.1003	1.50031.1003	1.51922.1003	on request	on request
250	x	4	1.50252.1003	1.50272.1003	on request	on request	on request
250	x	4.6	1.50359.1003	1.50032.1003	1.51921.1003	on request	on request
Guard cartridges LiChroCART® [10 units]							
4	x	4	1.50250.0001	1.50270.0001	on request	1.50267.0001	1.50249.0001

The LiChroCART® columns (75, 100, 125, 150 and 250 mm length) in the list above (2, 3, 4 and 4.6 mm I.D.) require part number [1.51486.0001](#) manu-CART® cartridge column holder, which can be used to hold one cartridge column with or without a 4-4 mm guard column. LiChroCART® columns 250-10 mm require part number [1.51419.0001](#) manu-CART® 10. Additional dimensions and validation kit available as customized packings see page 120.

Hibar® RT HPLC Column [1 unit]							
Length (mm)		I.D. (mm)	RP-18	RP-18 endcapped	Phenyl	NH2	Si
50	x	2	1.50593.0001	on request	on request	on request	on request
50	x	3	1.50607.0001	on request	on request	on request	on request
50	x	4	1.50621.0001	on request	on request	on request	on request
100	x	2	1.50595.0001	on request	on request	on request	on request
100	x	3	1.50612.0001	on request	on request	on request	on request
100	x	4.6	1.50622.0001	1.51917.0001	on request	on request	on request
125	x	2	1.50596.0001	on request	on request	on request	on request
125	x	3	1.50615.0001	on request	on request	on request	on request
125	x	4	1.50036.0001	1.50033.0001	on request	on request	on request
125	x	4.6	1.51914.0001	1.51916.0001	on request	on request	on request
150	x	2	on request	on request	on request	on request	on request
150	x	3	1.50617.0001	1.50644.0001	1.51920.0001	on request	on request
150	x	4.6	1.51455.0001	1.51453.0001	on request	on request	on request
250	x	2	1.50598.0001	on request	on request	on request	on request
250	x	3	1.50620.0001	on request	on request	on request	on request
250	x	4	1.50037.0001	1.50035.0001	on request	on request	on request
250	x	4.6	1.51456.0001	1.51454.0001	1.51918.0001	1.51913.0001	1.51911.0001
250	x	10	on request	on request	on request	on request	1.51912.0001
Validation Kits [3 Hibar® RT HPLC Columns from 3 different sorbent batches]							
125	x	4	1.50036.1003	1.50033.1003	on request		
150	x	3	1.50617.1003	1.50644.1003	1.51920.1003		
150	x	4.6	1.51455.1003	1.51453.1003	1.51919.1003		
250	x	4	1.50037.1003	1.50035.1003	on request		
240	x	4.6	1.51456.1003	1.51454.1003	1.51918.1003		

The Hibar® columns are complete with endittings. When using a guard column with a Hibar® column, we recommend part number [1.51487.0001](#) guard column cartridge holder for 4-4 mm guard column cartridges LiChroCART®. Additional dimensions available as customized packings see page 120.



Validation kits are available

HPLC Columns "on request" are available as Custom Product. Please see page 120/121

Purospher™ STAR (3 µm)

Column dimension				
Length (mm)		I.D. (mm)	RP-18 endcapped	RP-8 endcapped
LiChroCART® HPLC Cartridge [1 unit; * 3 units] [** One set contains: 1 LiChroCART® cartridge and one holder]				
30	x	2	on request	on request
30	x	4	1.50225.0001*	on request
55	x	2	1.50241.0001*	on request
55	x	2; Set**	1.50240.0001	on request
55	x	4	1.50231.0001*	on request
55	x	4; Set**	1.50242.0001	on request
75	x	4	1.51460.0001	on request

The LiChroCART® columns (75, 100, 125, 150 and 250 mm length) in the list above (2, 3, 4 and 4.6 mm I.D.) require part number [1.51486.0001](#) manu-CART® cartridge column holder, which can be used to hold one cartridge column with or without a 4-4 mm guard column. LiChroCART® columns 250-10 mm require part number [1.51419.0001](#) manu-CART® 10. Additional dimensions and validation kit available as customized packings see page 120.

Hibar® RT HPLC Column [1 unit]				
Length (mm)		I.D. (mm)	RP-18	RP-18 endcapped
50	x	3	1.50393.0001	on request
50	x	4	1.50428.0001	on request
100	x	3	1.50398.0001	on request
100	x	4.6	1.50469.0001	on request
125	x	3	1.50413.0001	on request
125	x	4	1.50431.0001	on request
150	x	3	1.50414.0001	1.50750.0001
150	x	4.6	1.50470.0001	on request
250	x	3	1.50427.0001	on request
250	x	4	1.50468.0001	on request
250	x	4.6	1.50471.0001	on request
Validation Kits [3 Hibar® RT HPLC Columns from 3 different sorbent batches]				
125	x	4	1.50431.1003	on request
150	x	3	1.50414.1003	1.50750.1003
150	x	4.6	1.50470.1003	on request
250	x	3	1.50427.1003	on request
250	x	4	1.50468.1003	on request
250	x	4.6	1.50471.1003	on request

The Hibar® columns are complete with endittings. When using a guard column with a Hibar® column, we recommend part number [1.51487.0001](#) guard column cartridge holder for 4-4 mm guard column cartridges LiChroCART®. Additional dimensions available as customized packings see page 120.

Other Purospher™ Columns (5 µm)

Purospher™ HPLC columns can easily be replaced by the advanced Purospher™ STAR HPLC columns for many applications. Purospher™ STAR HPLC columns provide an extended pH stability and outstanding peak symmetry for basic and chelating compounds.

Column dimension				
Length (mm)		I.D. (mm)	RP-18	RP-18 endcapped
LiChroCART® HPLC Cartridge [1 unit]				
125	x	3	on request	1.50798.0001
125	x	4	1.50142.0001	1.50168.0001
250	x	3	on request	1.51384.0001
250	x	4	1.50144.0001	1.50169.0001
Guard cartridges LiChroCART® [10 units]				
4	x	4	1.50141.0001	1.50167.0001

The LiChroCART® columns (75, 100, 125, 150 and 250 mm length) in the list above (2, 3, 4 and 4.6 mm I.D.) require part number [1.51486.0001](#) manu-CART® cartridge column holder, which can be used to hold one cartridge column with or without a 4-4 mm guard column. LiChroCART® columns 250-10 mm require part number [1.51419.0001](#) manu-CART® 10. Additional dimensions and validation kit available as customized packings see page 120.



Validation kits are available

HPLC Columns "on request" are available as Custom Product. Please see page 120/121



Perfect peak shape

Accurate results rely on two important chromatographic properties of the stationary phase: resolution and peak shape. With Purospher™ STAR columns, high efficiency and bonded phase surface coverage produce sharp, symmetrical peaks for acidic, basic and chelating

compounds. This makes Purospher™ STAR RP-18 endcapped and RP-8 endcapped columns the optimal choice for pharmaceutical applications, USP methods as well as for general method development.

Purospher™ STAR RP-18 endcapped

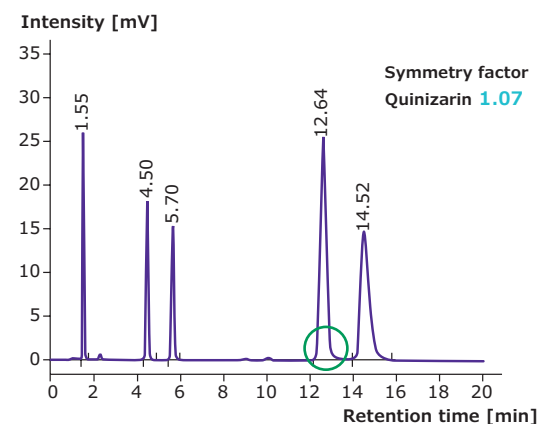

Column L

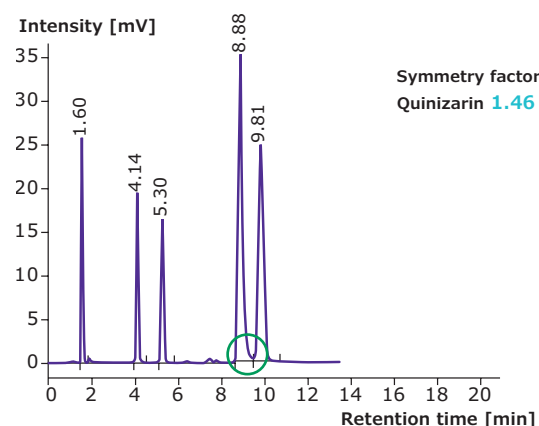

Column X

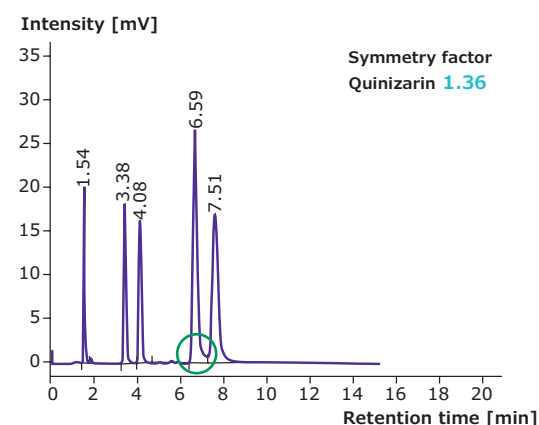

Column I

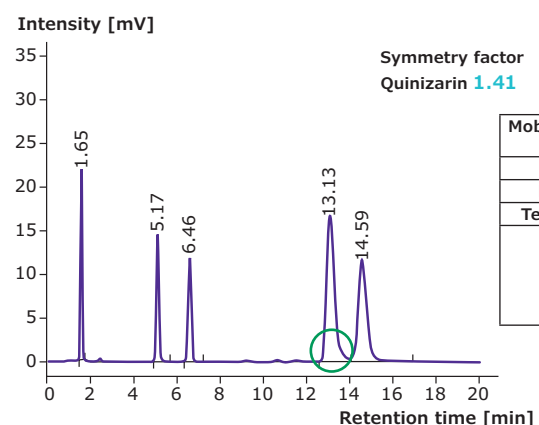

Mobile phase:	Methanol/Buffer pH 7.0 80/20
Flow rate:	1.0 mL/min
Detection:	UV 254 nm
Temperature:	22 °C
Sample:	1. Uracil; 2. Toluene; 3. Ethylbenzene; 4. Quinizarin; 5. Amitriptyline

Purospher™ STAR UHPLC columns

High resolution at lower column backpressure

Although UHPLC is typically performed with a particle size smaller than 2 µm, we employ 2 µm particles due to two important factors. Firstly, column efficiency and backpressure depends on the particle size of the column material. Secondly, column efficiency is also highly influenced by instrument effects. When UHPLC columns with 1.7 µm, 1.8 µm, 1.9 µm and 2 µm particles are compared on the same instrument and under the same conditions, results show no significant difference in efficiency. However, column pressure varies substantially among the different particle size materials. For example, a 1.7 µm particulate material significantly higher column backpressure, compared to a 2 µm material.

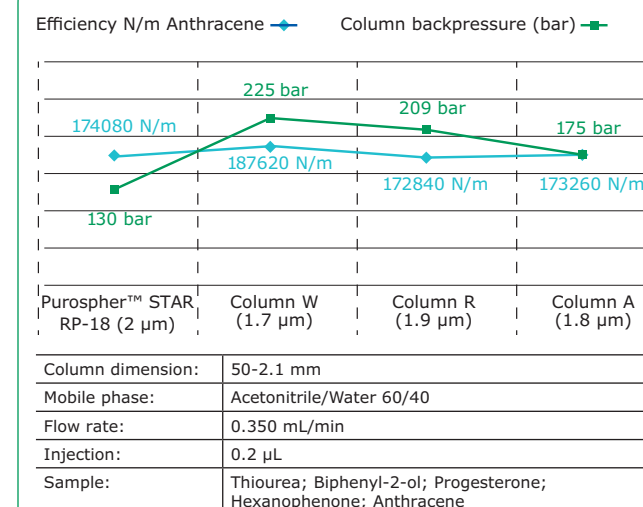

Chromatographic conditions

Column temperature:	40°C
Eluents:	A. Water, B. Acetonitrile
UV:	247 nm
Injection volume:	10 µL

Green: Purospher™ STAR RP-18e (5 µm) LiChroCART® 150-4.6

Gradient:	0 min 45 % B, from 45 to 95 % B in 15 min, from 15.1 to 20 min reequilibration with 45 % B
Flow rate:	1.0 mL/min
Pressure:	105 bar
Total run time:	20 min

Purple: Purospher™ STAR RP-18e (2 µm) Hibar® HR 50-2.1

Gradient:	0 min 45 % B, from 55 to 100 % B in 0.8 min from 0.9 to 2 min reequilibration with 55 % B
Flow rate:	1.1 mL/min
Pressure:	505 bar
Total run time:	2 min

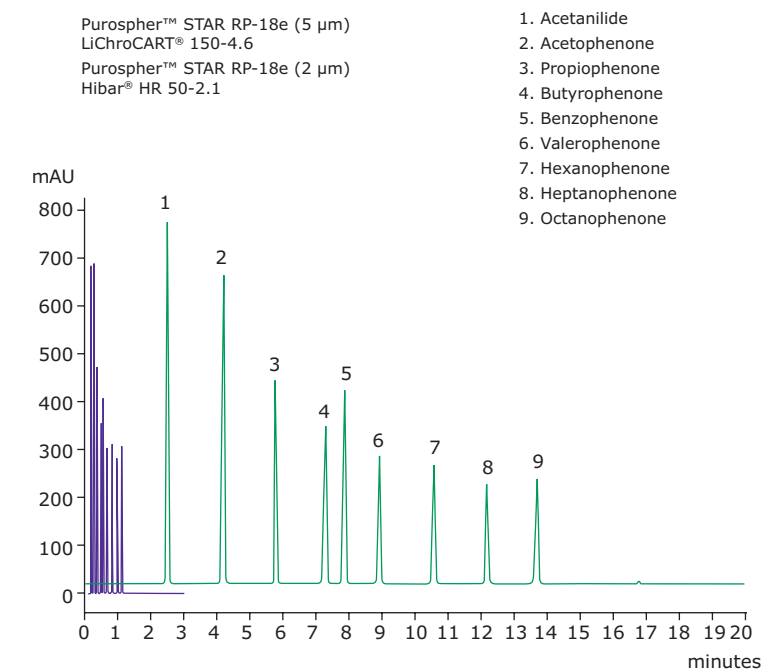

Excellent for LC-MS

In order to obtain sensitive results with LC-MS, it is essential to avoid trace impurities in the column and solvents. Purospher™ STAR HPLC and UHPLC columns are highly suitable for LC-MS. To ensure low and stable background signals, it is recommended to wash columns with an eluent of isopropanol and 0.1% formic acid. Displayed here is an extracted ion chromatogram of NSAIDs in negative ion mode separated on Purospher™ STAR RP-18 endcapped

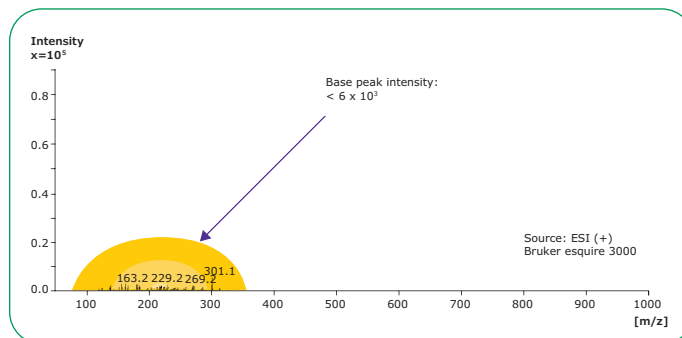

Extracted ion chromatograms of NSAIDs in negative ion mode separated on Purospher™ STAR RP-18 endcapped

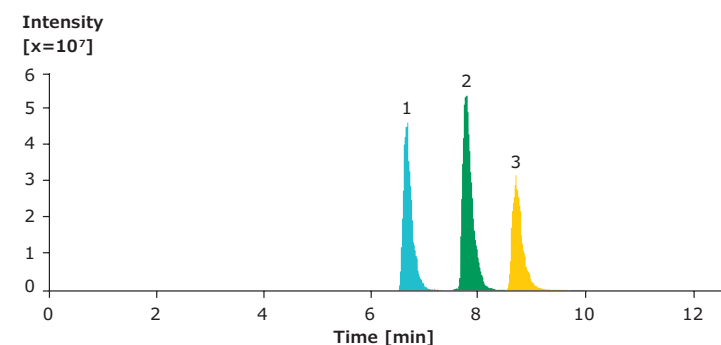

ETC 209; 253; 507 – All MS
ETC 197; 241; 483 – All MS
ETC 161; 205; 411 – All MS

Chromatographic conditions

Column:	Purospher™ STAR RP-18 endcapped, 3 µm, LiChroCART® 55-2
Mobile phase A:	0.1 % Acetic acid in Acetonitrile
Mobile phase B:	0.1 % Acetic acid in Water
Gradient:	From 25 % A to 50 % A in 3 min, then isocratic
Flow Rate:	300 µL, without split
Detection:	UV 220 nm, Ion Trap MS
Temperature:	ambient
Injection volume:	1 µL
Sample:	1. Ketoprofen 0.1 µg/µL 2. Fenoprofen 0.1 µg/µL 3. Ibuprofen 0.1 µg/µL

MS conditions

Ionization:	ESI(-)
Nebulizer:	36 psi
Dry gas:	8.5 L/min
Dry temperature:	330 °C
Smart mode optimization:	Target mass 205
Ion charge control:	Target 50,000, max 50 ms
Scan mode:	Standard/Normal
Scan range:	50 – 600 m/z

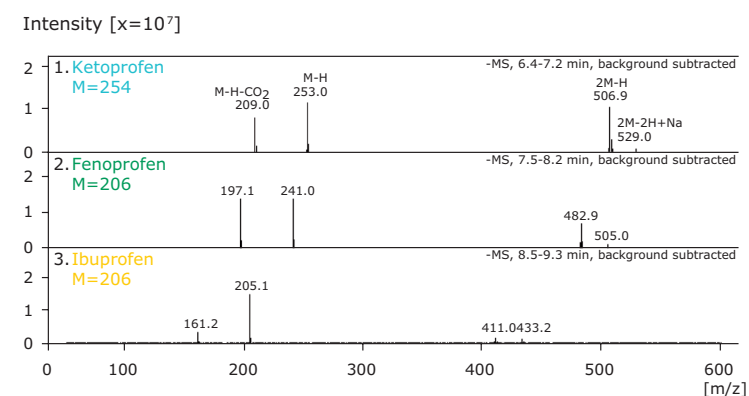

Ketoprofen, Fenoprofen and Ibuprofen (100 ng) give ghost-peak-free MS spectra using LiChrosolv® Acetonitrile hypergrade and Purospher™ STAR RP-18 endcapped columns.



Purospher™ STAR Hibar® HR UHPLC Columns [2 µm and 3 µm particle size]

Column dimension		I.D. (mm)	RP-18 e (2 µm)	RP-18 e (3 µm)	RP-8 e (2 µm)	RP-8 e (3 µm)	Phenyl (2 µm)	Phenyl (3 µm)
Hibar® HR UHPLC Column [1 unit]								
30	x	2.1	1.50645.0001	1.50650.0001	on request	on request	on request	on request
50	x	2.1	1.50646.0001	1.50651.0001	1.50630.0001	1.50674.0001	1.51013.0001	on request
100	x	2.1	1.50648.0001	1.50653.0001	1.50629.0001	1.50675.0001	1.51014.0001	1.50673.0001
150	x	2.1	1.50649.0001	1.50654.0001	on request	on request	on request	on request
250	x	2.1	on request	1.50655.0001	on request	on request	on request	on request
Validation Kits [3 Hibar® HR UHPLC Columns from 3 different sorbent batches]								
100	x	2.1	1.50648.1003	1.50653.1003	1.50629.1003	1.50675.1003	on request	on request

Hibar® HR UHPLC columns are designed for use in UHPLC instruments. The pressure stability is set at 1000 bar.

HPLC Columns "on request" are available as Custom Product. Please see page 120/121

Discovery® HPLC Columns

Alternative selectivities for straightforward method development

The Discovery® HPLC columns are available with a broad range of modifications providing the best suitable selectivity for many applications. Although designed to meet the exacting requirements of pharmaceutical analysis and purification, Discovery® columns are also ideal for all application segments requiring reversed-phase HPLC

Method development scientists often choose a single stationary phase for development. If the chosen phase is not the best chemistry to yield a given separation, many hours may be spent studying mobile phase compositions that may or may not yield a suitable separation. Screening several stationary phase chemistries up front during method development and choosing the best phase for further optimization can save many precious hours. In addition, the use of a more effective stationary phase chemistry often eliminates the need for mobile phase additives that can greatly complicate separation conditions.

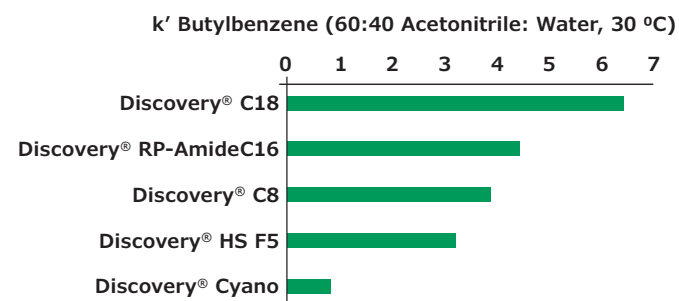

Hydrophobic Retention Ranking of Discovery® Reversed-Phases

As a visual representation of how the different phase chemistries give different selectivity, the chart at right shows the k' of various analytes relative to toluene on Discovery® columns.

The polar functional group-containing solutes - aniline, phenol, N,N-dimethylaniline (N,N-DMA) and ethylbenzoate - clearly illustrates the very different selectivities of the functionalized reversed-phases vs. C18. The colors representing solutes containing polar groups dramatically change positions from phase to phase. Also, observe the changing hydrophobic selectivity by looking at the ethylbenzene bar.

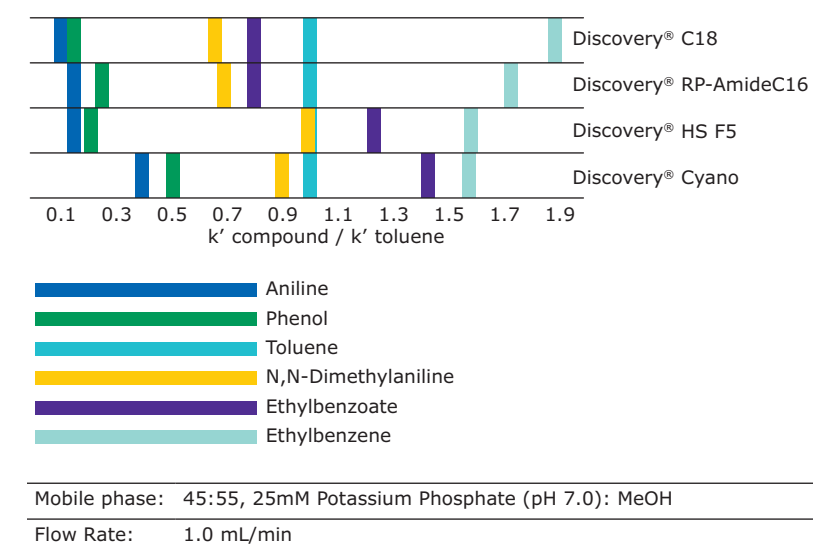

Mobile phase: 45:55, 25mM Potassium Phosphate (pH 7.0): MeOH

Flow Rate: 1.0 mL/min

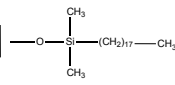
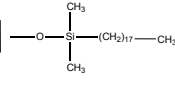
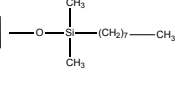
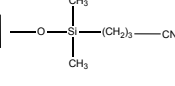
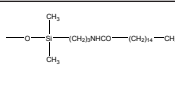
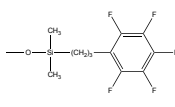
Phase Bonding	USP Designation	Bonding Chemistry	Chromatographic Properties / Use	Particle Size (µm)	Pore Size (Å)	Surface Area (m ² /g)	Carbon Load (%)	Surface Coverage (µmol/m ²)	pH Stability	Max Temperature	Endcapped	Shipping Eluent
 C18	L1	Octadecyl	Classic reversed-phase selectivity and retention with excellent peak shape for all compounds. Very high stability and no-bleed properties for LC-MS applications	5	180	200	12	3	2 - 8	70 °C	No	34% Water: 66% Methanol
 HS C18	L1	Octadecyl	Non-polar, reversed-phase column with excellent, no bleed LC-MS performance. Higher hydrophobicity for better resolution of difficult analytes.	3, 5, 10	120	300	20	3.8	2 - 8	70 °C	Yes	30% Water: 70% Methanol
 C8	L7	Octyl	Less hydrophobic reversed-phase selectivity and retention with excellent peak shape for all compounds. Very high stability and no-bleed properties for LC-MS applications	5	180	200	7.5	3.4	2 - 8	70 °C	Yes	100% Methanol
 Cyano	L10	Cyanopropyl	Cyanopropyl reversed-phase column with lower hydrophobicity than C18 or C8 and unique selectivity. Excellent peak shape, significantly less retention than C18 (typically requires lower % organic mobile phase) and high stability with mobile phase). Low-bleed for LC-MS separations	5	180	200	4.5	3.5	2 - 8	70 °C	Yes	Acetonitrile
 RP-Amide C16	L60	Palmitamidopropyl	Polar-embedded, palmitamidopropyl reversed-phase column with unique retention and selectivity. Excellent peak shape and efficiency. Due to the nature of the bonded phase, we do not recommend the RP-AmideC16 be used for LC-MS applications	5	180	200	12	2.6	2 - 8	70 °C	Yes	Acetonitrile
 HS F5 (PFP)	L43	Pentafluorophenylpropyl	Pentafluorophenyl terminated reversed-phase column with unique retention and selectivity (e.g. basic & halogenated compounds). The Discovery® HS F5 bonded phase provides reversed-phase separations that are distinctly different from C18 columns. However, compounds will generally elute within the same retention time window, making most C18 methods easily transferable. Excellent peak shape and stable, low-bleed LC-MS separations	3, 5, 10	120	300	12	4	2 - 8	70 °C	Yes	Acetonitrile

Discovery® (5 µm)

Column dimension								
Length (mm)		I.D. (mm)	HS C18	C18	C8	RP-Amide C16	HS F5 (PFP)	Cyano
20	x	2.1	on request	577507-U	577501-U	on request	on request	on request
30	x	2.1	on request	on request	on request	on request	on request	on request
50	x	2.1	568500-U	50494721	on request	on request	567508-U	on request
100	x	2.1	568501-U	569220-U	on request	569320-U	567510-U	on request
125	x	2.1	on request	569229-U	on request	on request	on request	on request
150	x	2.1	568502-U	50495521	59353-U21	50501321	567511-U	on request
250	x	2.1	568503-U	on request	on request	on request	567512-U	on request
20	x	3	on request	on request	on request	on request	on request	on request
30	x	3	on request	on request	on request	on request	on request	on request
50	x	3	on request	on request	on request	on request	on request	on request
100	x	3	on request	on request	on request	on request	on request	569522-U
125	x	3	on request	on request	on request	on request	on request	on request
150	x	3	on request	on request	on request	on request	on request	on request
250	x	3	on request	on request	on request	on request	on request	on request
50	x	4	568510-U	on request	on request	on request	on request	on request
100	x	4	on request	569222-U	on request	on request	on request	on request
125	x	4	on request	569231-U	569426-U	on request	on request	569526-U
150	x	4	568512-U	on request	on request	on request	567535-U	on request
250	x	4	568513-U	on request	on request	on request	567536-U	on request
20	x	4.6	on request	on request	on request	on request	on request	on request
30	x	4.6	on request	on request	on request	on request	on request	on request
50	x	4.6	568520-U	504947	59352-U	505005	567513-U	on request
100	x	4.6	568521-U	569223-U	on request	on request	567515-U	on request
125	x	4.6	on request	569232-U	569427-U	on request	on request	on request
150	x	4.6	568522-U	504955	59353-U	505013	567516-U	59356-U
250	x	4.6	568523-U	504971	59354-U	505064	567517-U	59357-U
50	x	10	on request	on request	on request	on request	on request	on request
100	x	10	on request	on request	on request	on request	on request	on request
150	x	10	on request	on request	on request	on request	on request	on request
250	x	10	568533-U	569224-U	on request	on request	567520-U	on request
50	x	21.2	on request	on request	on request	on request	on request	on request
100	x	21.2	on request	on request	on request	on request	on request	on request
150	x	21.2	on request	on request	on request	on request	on request	on request
250	x	21.2	568543-U	569226-U	on request	on request	567523-U	on request
Discovery® Validation Packs (3 columns, each from a different lot of bonded phase)								
50	x	2.1	on request	on request	on request	on request	on request	on request
100	x	2.1	on request	on request	on request	on request	on request	on request
150	x	2.1	on request	on request	on request	on request	on request	on request
50	x	4.6	on request	on request	on request	on request	on request	on request
100	x	4.6	on request	on request	on request	on request	on request	on request
150	x	4.6	on request	on request	on request	on request	on request	on request
250	x	4.6	on request	on request	on request	on request	on request	on request
Discovery® Supelguard™ Guard Cartridge (2 pack)								
20	x	2.1	on request	505188	59588-U	on request	567574-U	on request
20	x	3	on request	59576-U	on request	59578-U	on request	on request
20	x	4	568572-U	505137	on request	505099	567576-U	59586-U
Discovery® Supelguard™ Guard Cartridge (2 pack)								
20	x	2.1	on request	505161	on request	on request	567575-U	on request
20	x	3	on request	59575-U	on request	on request	on request	on request
20	x	4	568573-U	505129	59589-U	505080	567577-U	on request
			on request	on request	on request	on request	on request	on request

HPLC Columns "on request" are available as Custom Product. Please see page 120/121

 Validation kits are available

Discovery® (3 µm)

Column dimension			
Length (mm)		I.D. (mm)	HS C18
30	x	2.1	on request
50	x	2.1	569253-U
75	x	2.1	569254-U
100	x	2.1	on request
150	x	2.1	569255-U
30	x	3	on request
150	x	3	on request
50	x	4	on request
75	x	4	on request
100	x	4	on request
150	x	4	on request
50	x	4.6	569250-U
75	x	4.6	569251-U
100	x	4.6	on request
150	x	4.6	569252-U
Discovery® Supelguard™ Guard Cartridge (2 pack)			
20	x	2.1	569276-U
20	x	4	569274-U
Discovery® Supelguard™ Guard Kit (Guard cartridge, stand-alone holder, tubing, 2 nuts and ferrules)			
20	x	2.1	on request
20	x	4	569275-U

HPLC Columns "on request" are available as Custom Product. Please see page 120/121

Discovery® (10 µm)

Column dimension		
Length (mm)	I.D. (mm)	HS C18
50	x	10
100	x	10
150	x	10
250	x	10
50	x	21.2
100	x	21.2
150	x	21.2
250	x	21.2

Discovery® BIO

Reversed-Phase Solutions to Protein and Peptide Separation Challenges

Discovery® BIO Wide Pore reversed-phase columns satisfy the need for efficiency, selectivity, LC-MS sensitivity, stability, scalability, and reproducibility for reversed-phase HPLC analyses of proteins, peptides, and small biomolecules. Three phase chemistries, C18, C8, and C5, give unmatched selectivity and performance. Separations are completely scalable from analytical to preparative column dimensions. The low-bleed, inert surface chemistry make them ideal for proteomics and LC-MS applications.

Features and Benefits

- Better protein and peptide resolution compared to leading RP-HPLC FPP columns
- High efficiency for peptide mapping
- Complementary selectivity choices with C5, C8, and C18 phase chemistries
- C5 has enhanced stability and lifetime compared to conventional C4 phases
- Excellent LC-MS properties
- Reliable reproducibility run-to-run, column-to-column, batch-to-batch

Choosing a Discovery® BIO Wide Pore Reversed Phase for Sample and Separation Modes

Sample or Usage	Separation Mode	Discovery® BIO Product
Peptide Mapping / Proteolytic Digests	Reversed-phase	Discovery® BIO Wide Pore C18 Discovery® BIO Wide Pore C8
Hydrophobic Peptides	Reversed-phase	Discovery® BIO Wide Pore C5
Proteins	Reversed-phase	Discovery® BIO Wide Pore C5

Discovery® BIO Wide Pore HPLC columns are packed with C5, C8, or C18 ligands bonded to 3, 5, or 10 µm, spherical, high purity silica particles containing 300 Å pores. All Discovery® BIO Wide Pore products provide stable, efficient, and reproducible separations of proteins and peptides. The low-bleed character and excellent peak shape without TFA in the mobile phase makes these columns ideal for proteomics and other LC-MS applications and preparative purifications.

Phase Bonding	Particle Size (µm)	Pore Size (Å)	Surface Area (m²/g)	Carbon Load (%)	Surface Coverage (µmol/m²)	pH Stability	Max Temperature	Endcapped	Shipping Eluent
C18	3, 5, and 10	300	100	9	3.6	2 to 8	70 °C	Yes	Acetonitrile/Water
C8	5 and 10	300	100	5	4	2 to 8	70 °C	Yes	Acetonitrile/Water
C5	3, 5, and 10	300	100	3.5	4.5	2 to 8	70 °C	Yes	Acetonitrile/Water

Discovery® BIO Wide Pore C18 Stability at pH 11.5

Column:	Discovery® BIO Wide Pore C18, 5 cm x 2.1 mm I.D., 3 µm (567200-U)
Mobile phase:	65:35, 50 mM pyrrolidine HCl, pH 11.5: acetonitrile
Flow rate:	0.7 mL/min
Column temp.:	35 °C

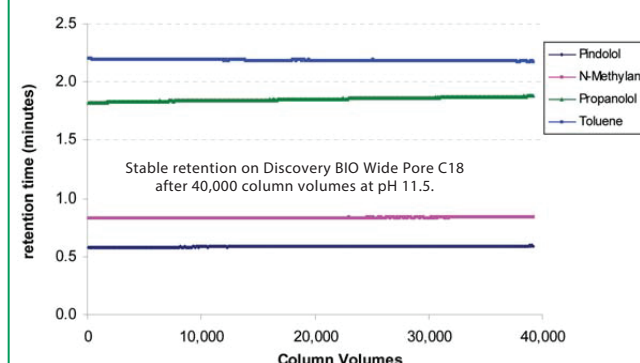

Note: Stability was measured using small molecule probes because they are generally more sensitive to changes in the silica and bonded phase chemistry than peptides and proteins. If the retention and selectivity for the small molecule probes does not change, it is very likely that the retention and selectivity for proteins and peptides will be stable as well.

Tryptic Digest of Carboxymethylated Apohemoglobin on a Discovery® Wide Pore C18 versus Competitive Columns

Columns:	(A) Discovery® BIO Wide Pore C18, 15 cm x 4.6 mm, 5 µm (568222-U), (B) and (C) Competitive protein and peptide C18, 15 cm x 4.6 mm, 300 Å, 5 µm;
Mobile phase:	(A) 95:5, (0.1% (v/v) TFA in water):(0.1% (v/v) TFA in acetonitrile); (B) 50:50, (0.1% (v/v) TFA in water):(0.1% (v/v) TFA in acetonitrile)
Gradient:	0-100% B in 65 min
Flow rate:	1.0 mL/min
Column temp.:	30 °C
Detector:	UV, 215 nm
Injection:	50 µL
Sample:	Carboxymethylated apohemoglobin tryptic digest, varied concentration, 50 mM aqueous ammonium bicarbonate

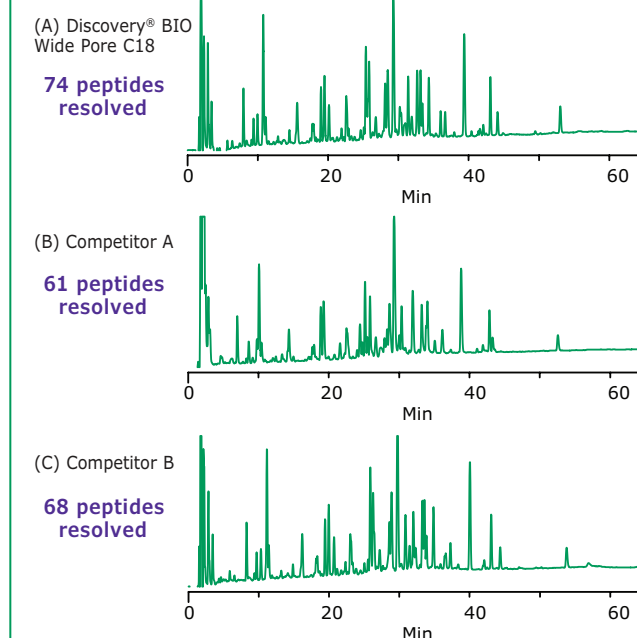

Note: The absolute number of peptides detected depends on the detector settings. In this comparison, the relative number of detected peptides is important, not the absolute number. The Discovery® BIO Wide Pore C18 column detected more peptides relative to the competitive columns under the same conditions.

Ordering Information

Discovery® BIO (3.0 µm)

Length (mm)	I.D. (mm)	C18	C5
50	x 1.0	on request	65511-U
50	x 2.1	567200-U	567226-U
100	x 2.1	567201-U	567227-U
150	x 2.1	567202-U	567228-U
50	x 4.6	on request	567229-U
100	x 4.6	567204-U	567230-U
150	x 4.6	567205-U	567231-U
Guard 2 pk	x 2.1	567270-U	567278-U
Guard 2 pk	x 4.0	on request	567280-U
Guard Kit	x 2.1	567271-U	on request
Guard Kit	x 4.0	on request	567281-U

Discovery® BIO (10.0 µm)

Length (mm)	I.D. (mm)	C18	C8	C5
250	x 4.6	on request	on request	567232-U
50	x 10.0	567207-U	on request	on request
150	x 10.0	567208-U	on request	567234-U
250	x 10.0	567209-U	on request	567235-U
150	x 21.2	567211-U	on request	on request
250	x 21.2	567212-U	567225-U	on request

Discovery® BIO (5.0 µm)

Length (mm)	I.D. (mm)	C18	C8	C5
50	x 2.1	on request	on request	on request
100	x 2.1	on request	on request	on request
150	x 2.1	on request	on request	568402-U
250	x 2.1	568203-U	on request	on request
250	x 4.0	568213-U	on request	on request
50	x 4.6	on request	on request	568420-U
100	x 4.6	on request	on request	568421-U
150	x 4.6	568222-U	on request	568422-U
250	x 4.6	568223-U	568323-U	568423-U
250	x 10.0	568230-U	on request	568430-U
250	x 21.2	on request	567225-U	on request
Guard 2 pk	x 2.1	on request	on request	on request
Guard 2 pk	x 4.0	568272-U	on request	568472-U
Guard Kit	x 2.1	568271-U	on request	on request
Guard Kit	x 4.0	568273-U	on request	on request

HPLC Columns "on request" are available as Custom Product. Please see page 120/121

Ascentis® HPLC Columns

Ascentis® HPLC Columns are optimized to the three terms of the resolution equation: efficiency, retention and selectivity. Ascentis® bonded phases have a wide range of selectivities. It is likely that one or more Ascentis® phase will accomplish any small molecule HPLC separation. Packed in micro- to preparative hardware dimensions, Ascentis® products cover all HPLC application areas, including the most sensitive trace-level analyses.

The general features of the Ascentis® family include:

- High purity, type B silica for inertness, reproducibility and stability
- Modern bonding processes that optimize bonded phase coverage and maximize stability, while minimizing bleed and unwanted secondary interactions
- Wide selection of bonded phase chemistries and bare silica
- Phases with enhanced polar compound retention
- Compatible with LC-MS and all of today's sensitive instruments and methods
- Scalable selectivity from analytical to preparative
- High surface area silica for high preparative loading capacity

Phosphate buffers are often preferred in HPLC applications, but they are aggressive at high pH and can cause dissolution of silica, stripping of phase and voiding in columns and usually should be avoided at high pH conditions.

Ascentis® Columns have a pH stability of pH 2-8. Under special conditions, especially at lower temperature, Ascentis® C18, C8 and RP-Amide can be used with mobile phase conditions at pH 1.5 and pH 10, even with aggressive mobile phase conditions with phosphate and methanol.

Column: Ascentis® C18, Ascentis® C8 or Ascentis® RP-Amide, 5 cm x 3.0 mm I.D., 5 µm particles

Mobile phase: 40:60, 10 mM ammonium phosphate (pH 10):methanol

Flow rate: 0.9 mL/min.

Temp.: 25 °C

Et.: UV at 220 nm

Stability test mix: Uracil was used as a void marker. Dimethylaniline (DMA) was used as a polar basic analyte that is sensitive to phase loss and silanol activity. As end-capping is lost, peak shape and efficiency should suffer. Toluene provided neutral k' , efficiency and asymmetry marker. p-Xylene is a highly retained neutral efficiency marker that is very sensitive to loss of main phase due to its high k'

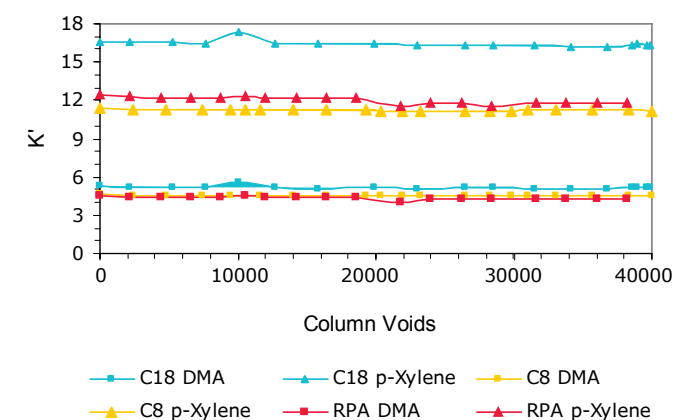

Phase Bonding	USP Designation	Bonding Chemistry	Chromatographic Properties / Use	Particle Size (µm)	Pore Size (Å)	Surface Area (m ² /g)	Carbon Load (%)	Surface Coverage (µmol/m ²)	pH Stability	Max Temperature	Endcapped	Shipping Eluent
C18	L1	Octadecyl	The classic reversed-phase column suitable for any method that specifies a C18-type column. Its high surface area gives Ascentis® C18 strong hydrophobic retention and high loading capacity for preparative applications. Ascentis® C18 is low-bleed for clean ESI and APCI traces. The high retentivity means that the mobile phase can contain high levels of organic modifier.	3, 5	100	450	25	3.7	2 - 8*	70 °C	Yes	40% Water: 60% Acetonitrile
C8	L7	Octyl	Ascentis® C8 is suitable for any method that specifies a C8-type column. Although C8 columns often show similar selectivity to C18 columns, shorter alkyl chains sometimes show different selectivity toward polar compounds because they can solvate differently with the mobile phase and interact differently due to the size and shape of certain molecules. Also, C8 reagents are smaller than C18 reagents and have improved primary phase coverage, thereby requiring less endcapping. Ascentis® C8 has excellent peak shape and very high phase stability.	3, 5	100	450	15	4.0	2 - 8*	70 °C	Yes	30% Water: 70% Methanol
Cyano	L10	Cyanopropyl	Useful for selectivity in the reversed-phase mode, including n-n and dipole-dipole interacting compounds. Can also be used in HILIC mode and normal phase chromatography.	5	100	450	10	2.5	1 - 8	70 °C	Yes	Acetonitrile
RP-Amide	L60	Palmitamidopropyl	Ascentis® RP-Amide can be used for many of the same separations as a C18 while avoiding some of the disadvantages of C18 such as poor wettability in high aqueous mobile phases. In addition, it is much more retentive for those molecules that can interact by hydrophobic interactions and also by H-bonding with the amide group. Compared to alkyl only phases, Ascentis® RP-Amide has enhanced retention and selectivity for phenols, organic acids and other polar solutes due to strong H-bonding between the amide carbonyl (H-bond acceptor) and H-bond donors, like phenols and acids. Compared to other embedded polar group (EPG) phases, like carbamates, ureas, sulfonamides and ethers, Ascentis® RP-Amide gives retention comparable to C18 and C8 for easy column comparison without the need to change mobile phase conditions.	3, 5	100	450	19.5	2.7	2 - 8*	70 °C	Yes	Acetonitrile
Phenyl	L11	Phenyl ring with short butyl spacer	Phenyl phases are n-basic (electron donating) and are similar in overall retention to alkyl and EPG phases for easy column screening. The alternate selectivity of phenyl phases is often explained by the n-n interactions available through the phenyl ring. They provide low-bleed for MS or UV gradient applications due to the use of trifunctional bonding reagent, outstanding phenyl selectivity due to high phase loading and short butyl spacer and 100% aqueous-compatible for highly-polar compounds	3, 5	100	450	19	5.2	2 - 8*	70 °C	Yes	35% Water: 65% Methanol
Silica	L3	unbonded	The classic use of silica columns is for normal phase HPLC. The rigid structure of the silica surface, as opposed to the flexible nature of bonded phases, allows it to distinguish between molecules with different molecular shape that may have the same hydrophobicity. Ascentis® Si columns provide a high-loading capacity and operates in both normal-phase and HILIC modes.	3, 5	100	450	n.a.	n.a.	2 - 6	70 °C	n.a.	Ethanol

*Under certain conditions such as low temperature, the column can be operated in the extended pH range from pH 1.5 - 10.

Ordering Information

Ascentis® (5 µm)

Column dimension		C18	C8	Phenyl	RP-Amide	ES Cyano	Si
Length (mm)	I.D. (mm)						
50	x 2.1	on request	on request	on request	565303-U	on request	on request
100	x 2.1	581326-U	on request	on request	565304-U	577301-U	581500-U
150	x 2.1	581304-U	on request	on request	565305-U	on request	581509-U
250	x 2.1	581305-U	on request	on request	565306-U	on request	581510-U
50	x 3	on request	on request	on request	on request	on request	on request
100	x 3	on request	on request	on request	on request	on request	on request
150	x 3	on request	on request	on request	on request	on request	on request
250	x 3	on request	on request	on request	on request	on request	on request
250	x 4	on request	on request	on request	565327-U	on request	on request
50	x 4.6	581323-U	on request	581615-U	565323-U	on request	on request
100	x 4.6	on request	on request	on request	565328-U	on request	on request
150	x 4.6	581324-U	581424-U	581616-U	565324-U	577306-U	581512-U
250	x 4.6	581325-U	581425-U	581617-U	565325-U	577307-U	581513-U
50	x 10	on request	on request	on request	on request	on request	on request
100	x 10	on request	on request	on request	on request	on request	on request
150	x 10	581342-U	on request	on request	on request	on request	on request
250	x 10	581343-U	on request	581618-U	565344-U	on request	581514-U
50	x 21.2	on request	on request	on request	on request	on request	on request
150	x 21.2	581346-U	on request	on request	565347-U	on request	on request
250	x 21.2	581347-U	581442-U	581619-U	565348-U	on request	581515-U

Ascentis® Validation Packs (3 columns, each from a different lot of bonded phase)

150	x 4.6	on request	on request	on request	on request	on request	on request
250	x 4.6	on request	on request	on request	on request	on request	on request

Ascentis® Supelguard™ Guard Cartridge (2 pack)

20	x 2.1	581370-U	on request	on request	565372-U	on request	on request
20	x 3	581374-U	on request	on request	on request	on request	on request
20	x 4	581372-U	581426-U	581620-U	565370-U	on request	581518-U

Ascentis® Supelguard™ Guard Kit (Guard cartridge, stand-alone holder, tubing, 2 nuts and ferrules)

20	x 2.1	on request	on request	on request	565373-U	on request	on request
20	x 4	581373-U	581427-U	581621-U	565371-U	on request	581519-U

Ascentis® (3 µm)

Column dimension		C18	C8	RP-Amide	Si
Length (mm)	I.D. (mm)				
20	x 2.1	on request	on request	565313-U	on request
30	x 2.1	on request	581414-U	on request	581522-U
50	x 2.1	581300-U	581400-U	565300-U	581500-U
75	x 2.1	on request	on request	on request	on request
100	x 2.1	581301-U	581401-U	565301-U	on request
150	x 2.1	581302-U	581402-U	565302-U	581502-U
20	x 3	on request	on request	on request	on request
30	x 3	on request	on request	on request	on request
100	x 3	581308-U	on request	565312-U	581503-U
20	x 4.6	on request	on request	on request	on request
50	x 4.6	581320-U	on request	565320-U	on request
100	x 4.6	581321-U	581407-U	565321-U	on request
150	x 4.6	581322-U	581408-U	565322-U	on request

Ascentis® Supelguard™ Guard Cartridge (2 pack)

20	x 2.1	581377-U	on request	on request	on request
20	x 4	on request	on request	on request	on request

Ascentis® Supelguard™ Guard Kit (Guard cartridge, stand-alone holder, tubing, 2 nuts and ferrules)

20	x 2.1	581376-U	on request	on request	on request
20	x 4	581379-U	on request	on request	on request



Validation kits are available

HPLC Columns "on request" are available as Custom Product. Please see page 120/121

All Supelco® HPLC columns including the complete range of Fully Porous Particles (FPP), Superficially Porous Particles (SPP) and Monolithic Columns (Chromolith®) perfectly fit to every HPLC, UHPLC and UPLC® instrument independent of the instrument supplier.



Titan™ UHPLC Columns

Titan™ UHPLC columns, based on 1.9 µm fully porous monodisperse silica, outperform other UHPLC columns. These UHPLC columns provide the performance scientists expect (> 250,000 N/m).

The Titan™ particle is based on spherical, fully porous silica, with an ultra-narrow particle size distribution for optimum efficiency. Research findings support observations that porous-layer particles with very narrow particle size distribution demonstrate superior efficiency and kinetic performance. Uniform Titan™ particles are packed into rugged column beds that are stable over a range of UHPLC flow and pressure conditions. Excellent batch reproducibility and robustness is also noted.

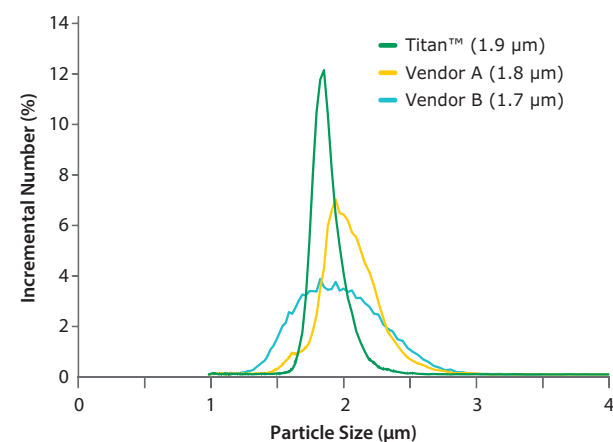

Comparison of Particle Size Distribution for Different Sub-2 µm Porous Particles

Titan™ Porous Silica Characteristics

Particle Size* µm	Pore Diameter Å	Surface Area m ² /g	Pore Volume cc/g	Pressure psi (bar)
1.9	80	410	0.76	18000 (1241)

*Very narrow distribution: D (90/10) < 1.15

The performance for a Titan™ column is improved compared to smaller, Porous Particles that have broader size distributions. Lower values for reduced plate height (h), which is plate height (H) divided by particle diameter, is very significant for Titan™ columns because it means that higher column efficiency is observed with larger particles which create lower pressure drop.

The efficiency advantage for Titan™ over commercial 1.8 µm and 1.7 µm Porous Particles confirms that Titan™ 1.9 µm column pressure is lower than 1.7 µm or 1.8 µm particle columns and is actually closer to a 2.5 µm particle column.

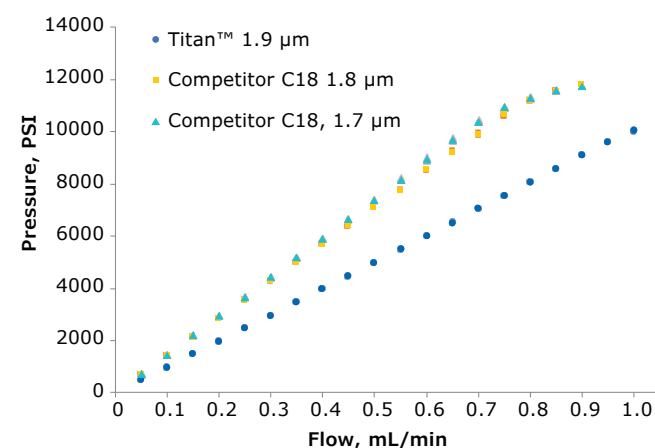

Independent Evaluation of Titan™ Pressure Drop

Titan™ C18, 1.9 µm
N = 14,710
N/m = 294,200
h = 1.75
σ = 1.05
Pressure* = 4,100psi

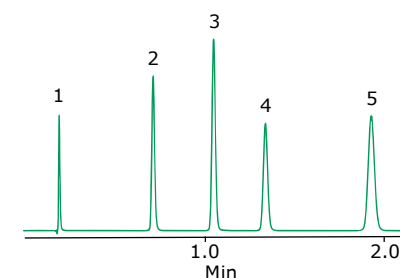

Competitor A C18, 1.8 µm
N = 9,260
N/m = 185,200
h = 3.18
σ = 1.02
Pressure* = 4,650psi

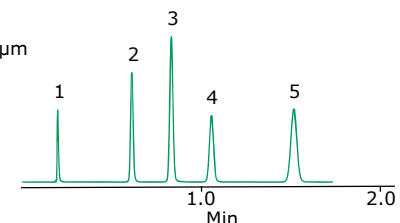

Competitor B C18, 1.7 µm
N = 9,783
N/m = 195,700
h = 2.84
σ = 1.16
Pressure* = 4,900psi

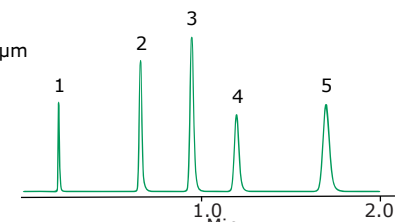

* Total System Pressure

Titan™ C18 Performance Comparison vs. Competitor UHPLC Columns

Ordering Information

Length (mm)	I.D. (mm)	Qty.	Cat. No.
Titan™ C18 Columns, 1.9 µm			
20	x 2.1	1	577120-U
30	x 2.1	1	577121-U
50	x 2.1	1	577122-U
75	x 2.1	1	577123-U
100	x 2.1	1	577124-U
30	x 3.0	1	577125-U
50	x 3.0	1	577126-U
Titan™ C18 Guard Cartridges, 1.9 µm			
5	x 2.1	3	577127-U
5	x 3.0	3	577128-U
Titan™ Guard Cartridge Holder (cartridge not included)			577133-U

Titan™ Outperforms Other Fully Porous UHPLC Columns

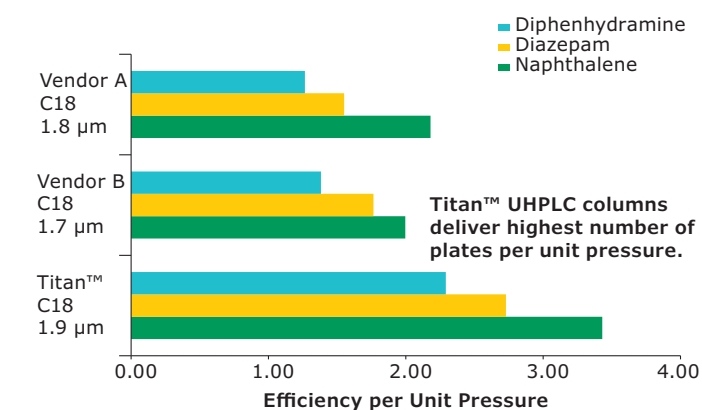

Titan™ UHPLC columns deliver highest number of plates per unit pressure.

SeQuant® HILIC HPLC and Capillary Columns



ZIC®-HILIC, ZIC®-cHILIC and ZIC®-pHILIC are the ideal columns for all classes of polar and hydrophilic compounds

SeQuant® HILIC (hydrophilic interaction liquid chromatography) HPLC columns constitute a range of high-performance tools for separating polar, hydrophilic compounds. All columns carry densely bonded, truly zwitterionic functional groups with a charge balance of 1:1. Separation is achieved by hydrophilic partitioning combined with weak ionic interactions for maximum selectivity, high loadability and easy optimization of methods.

Features and Benefits

- High-performance HPLC and LC-MS separations of polar hydrophilic compounds
- Zwitterionic stationary phase ensures reproducible retention
- Two complementary phase chemistries
- Maximum LC-MS compatibility with minimized column bleed
- Excellent reproducibility and robustness
- Available in a variety of lengths, particle sizes, and pore dimensions

Choose your SeQuant® HILIC selectivity

SeQuant® Column	Functional Group	Features	Base Particle	Particle Size	Pore Size	Column Types
SeQuant® ZIC®-HILIC	 Sulfobetaine	High-performance selectivity and robustness	silica	3.5 µm, 5 µm	100 Å, 200 Å	analytical, capillary, semi-prep, guards
SeQuant® ZIC®-cHILIC	 Phosphoryl-choline	Complementary selectivity with favorable LC-MS performance	silica	3 µm	100 Å	analytical, capillary, guards
SeQuant® ZIC®-pHILIC	 Sulfobetaine	High pH-stability and low noise with ion detectors	polymer	5 µm		analytical, guards

Your ideal choice for separation of all types of polar and hydrophilic compounds are the SeQuant® HILIC HPLC columns. Reproducible retention for compounds that have proved difficult to separate on reversed-phase HPLC columns is ensured by the high-performance zwitterionic sorbents in these columns.

Straightforward separation of compounds such as acids and bases, anions and cations, carbohydrates, metabolites, metal complexes, amino acids, peptides,

protein digests and oligonucleotides can therefore be achieved with a selectivity complementary to reversed-phase columns. Enhanced LC-MS sensitivity is an additional benefit of using these columns.

Columns are available in a wide range of formats from capillary to semi-preparative dimensions, and with several different particles sizes and pore sizes.

SeQuant® HILIC Analytical and Capillary HPLC Columns 

SeQuant® ZIC®-HILIC and ZIC®-cHILIC

The ZIC®-HILIC Column is designed to retain and separate all types of polar and hydrophilic compounds and for robust chromatography with high selectivity and reproducibility. The silica-based ZIC®-HILIC sorbent has a bonded stationary phase consisting of a highly polar, permanent zwitterion. Separation selectivity is favored by the 1:1 zwitterion charge balance, which makes the ZIC®-HILIC Column overall neutral, with weak, but important, ionic interactions. Tuning of the selectivity on the ZIC®-HILIC Column during method development is facilitated by the pH-independent, permanent zwitterion, ensuring that only the analytes (and not the column) is affected during eluent optimization.

SeQuant® ZIC®-cHILIC is designed for excellent HPLC and LC-MS of polar, hydrophilic compounds. This new, zwitterionic stationary phase with phosphorylcholine functional group provides you with complementary selectivity for easier method development for analytes that have been difficult to separate by previous types of HPLC columns operated in reversed-phase or HILIC mode.

SeQuant® ZIC®-HILIC

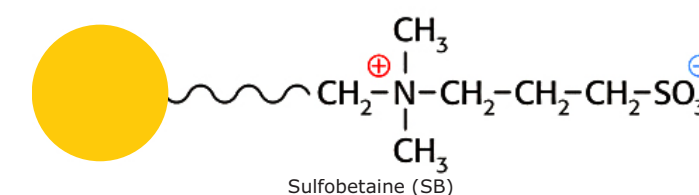

SeQuant® ZIC®-cHILIC

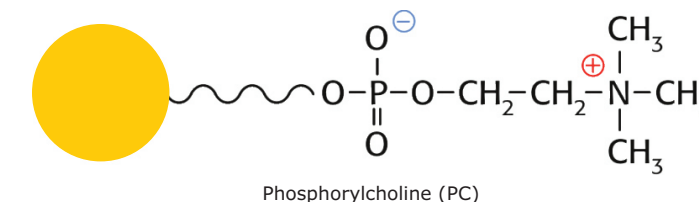

Isocratic separations of the positively charged benzyltrimethylamine (BTMA, peaks indicated with arrows) and the neutral toluene (void marker), uracil and cytosine on ZIC®-cHILIC (left) and ZIC®-HILIC (right) illustrating differences and similarities in selectivity caused by the different charge orientation of the zwitterionic functional groups (see illustrations).

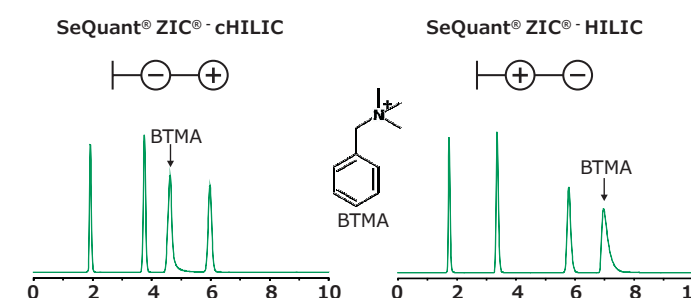

Chromatographic conditions

Column dimensions were 100 x 4.6 mm, particles size 3 or 3.5 µm, and pore size 100 Å. Eluent was 80 : 20 acetonitrile/ 25 mM aqueous ammonium acetate pH 6.8 pumped at 0.5 mL/min at 23 °C. Detection by UV absorption at 254 nm.

SeQuant® ZIC®-pHILIC

The ZIC®-pHILIC stationary phase has the same highly polar, bonded, permanent zwitterion, functional group as the silica-based ZIC®-HILIC Column. The user can therefore expect the same selectivity, however, with a trade-off in flow-rate range, and separation efficiency, common with polymeric materials. The more durable support allows for use in an extended pH range, which can be beneficial for certain applications.

The application example below illustrates how the selectivity of the ZIC®-pHILIC material can be enhanced by performing the separation at elevated pH. The chromatograms show isocratic separations of gentisic acid, protocatechuic acid and isophthalic acid on a ZIC®-pHILIC Column. The increase in pH also results in higher retention and improved peak shape for these analytes.

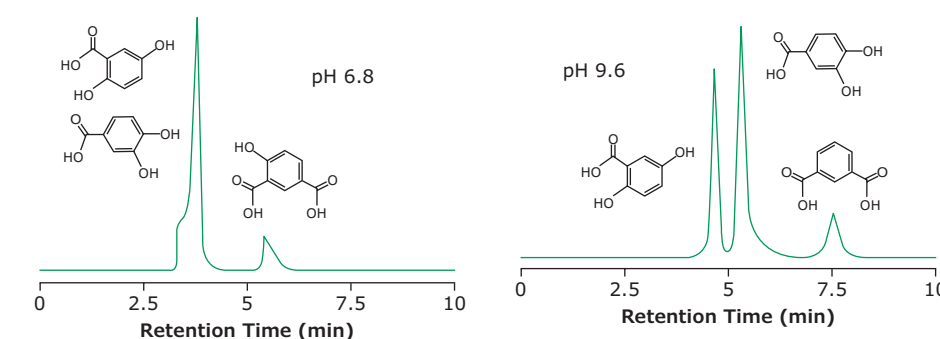

Outstanding suitability for LC-MS

Thanks to their favorable retention and robust performance, SeQuant® HILIC columns have become extremely popular in numerous laboratories around the world. For example, the US FDA (United States Food and Drug Administration) recommended SeQuant® ZIC®-HILIC for analysis of melamine and related substances. SeQuant® HILIC columns excel in stability and low bleed. These features make them particularly suitable for LC-MS applications where high background can lead to signal suppression and interference with quantitative measurements while also increasing instrument wear. The column's high stability makes these high-performance HILIC columns also attractive for traditional HPLC applications.

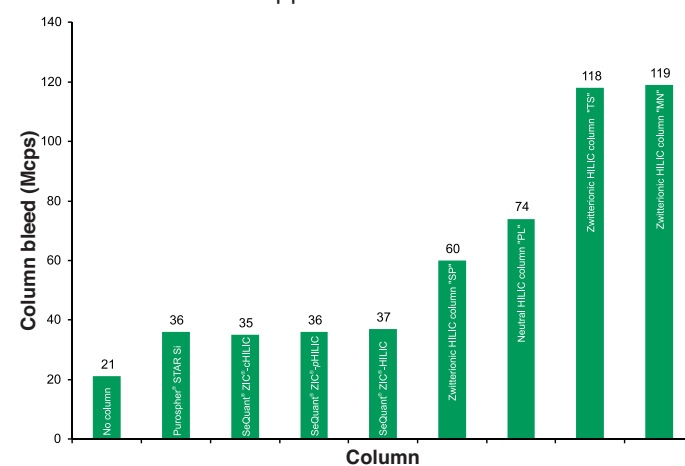

SeQuant® HILIC columns have been used in numerous methods for analysis of a wide variety of polar hydrophilic compounds such as acids and bases, anions and cations, carbohydrates, metabolites, metal complexes, amino acids, peptides, and protein digests.

Glycomics and Glyco- proteomics

SeQuant® ZIC® is the ideal sorbent for the separation and extraction of glycans and glycopeptides. A material pore size of 200 Å is recommended to avoid size-exclusion effects from the relatively large hydrodynamic volume of the hydrated glycan structures. Small I.D. HPLC columns are suitable for LC-MS methods, whereas larger conventional column dimensions are more appropriate for separations of labeled glycan structures detected with other techniques.

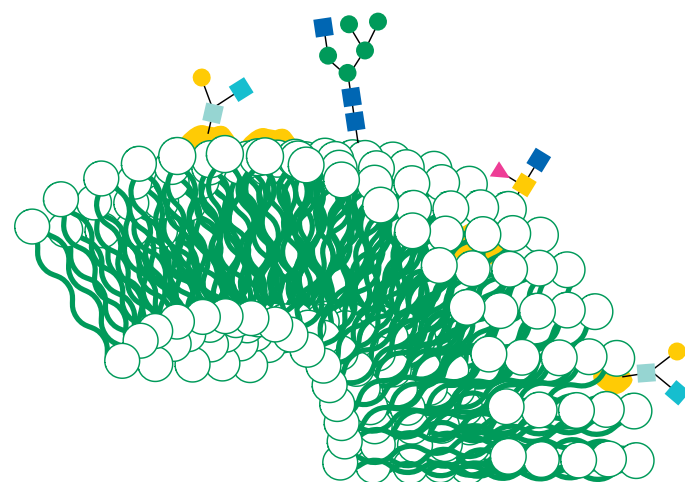

Peptide Mapping with High-Sequence Coverage

SeQuant® ZIC® HPLC columns are suitable for peptide mapping, especially so when exploring information from hydrophilic peptide fragments. Thanks to their advantageous combination of reversed phase chromatography and HILIC technology, the columns provide complementary information and may be coupled to an online 2-D peptide mapping approach.

Ordering Information

Column dimension		ZIC®-HILIC 200A, 5 µm	ZIC®-HILIC 100 A, 3.5 µm	ZIC®-HILIC 200A, 3.5 µm	ZIC®-cHILIC 100A, 3 µm	ZIC®-pHILIC, 5 µm
50	x 2.1	1.50450.0001	1.50440.0001	1.50445.0001	1.50656.0001	1.50459.0001
100	x 2.1	1.50452.0001	1.50441.0001	1.50447.0001	1.50657.0001	1.50462.0001
150	x 2.1	1.50454.0001	1.50442.0001	1.50448.0001	1.50658.0001	1.50460.0001
250	x 2.1	1.50457.0001	1.50443.0001			
50	x 4.6	1.50451.0001		1.50446.0001	1.50659.0001	1.50463.0001
100	x 4.6	1.50453.0001			1.50660.0001	1.50464.0001
150	x 4.6	1.50455.0001	1.50444.0001	1.50449.0001	1.50661.0001	1.50461.0001
250	x 4.6	1.50458.0001			1.50662.0001	
150	x 10	1.50493.0001				
250	x 10	1.50494.0001				
50	x 21.2	1.50496.0001				
150	x 21.2	1.50497.0001				
SeQuant® Capillary columns						
30	x 0.3			1.50489.0001		
30	x 1			1.50478.0001		
150	x 0.075	1.50465.0001				
150	x 0.3	1.50481.0001		1.50479.0001	1.50669.0001	
150	x 1	1.50482.0001	1.50487.0001	1.50480.0001	1.50670.0001	
SeQuant® Guard (1 piece; * 3 Pieces; **5 pieces)						
5	x 0.3	1.50492.0001 **			1.50765.0001 *	
5	x 1	1.50490.0001 **			1.50766.0001 *	
20	x 2.1	1.50435.0001	1.50439.0001			1.50437.0001
SeQuant® Guard Kit (3 guard columns including column coupler)						
20	x 2.1				1.50764.0001	1.50438.0001
20	x 1	1.50436.0001				
Guard Fitting	x 14x1	1.50434.0001				

LiChrospher® HPLC columns

Classical silica carrier for consistent results

LiChrospher® is the name given to reliable and versatile, traditionally produced spherical silica carriers (Type A). LiChrospher® silica carriers are available in a number of different modifications. The polar modified phases LiChrospher® CN, LiChrospher® NH2 and LiChrospher® DIOL as well as LiChrospher® Si with no modification are best for normal-phase HPLC. The non-polar modified phases LiChrospher® RP-8, RP-8 endcapped, RP-select B, RP-18, RP-18 endcapped are made for reversed-phase separations. Furthermore, LiChrospher® PAH is highly efficient and selective for the separation of PAHs.

LiChrospher® packing materials are available as Hibar® RT columns and as LiChroCART® cartridges of various lengths and internal diameters (10 mm, 4.6 mm, 4 mm, 3 mm and 2 mm). LiChroCART® 3 mm I.D.

and 2 mm I.D. narrow bore cartridges for HPLC save costs by reducing solvent consumption and allow the handling of very small quantities with excellent sensitivity and resolution. LiChroCART® cartridges 4.6 mm, 4 mm I.D., 3 mm I.D. and 2 mm I.D. are compatible with manu-CART® "4". This trait facilitates faster and more flexible method adaptation to smaller bore columns. LiChroCART® cartridges 10 mm I.D. have to be used with manu-CART® "10".

For improvements in resolution, column efficiency and peak symmetry as well as for fast and UHPLC applications, we recommend alternatives based on more advanced column technology such as Type B silica, Superficially Porous Particles or monolithic columns.

Phase Bonding	USP Designation	Bonding Chemistry	Particle Size (µm)	Pore Size (Å)	Pore volume (mL/g)	Surface Area (m²/g)	Carbon Load (%)	Surface Coverage (µmol/m²)	pH Stability	Max Temperature	Endcapped	Shipping Eluent
RP-18	L1	Octadecylsilane	5, 10	100	1.25	350	21	3.61	2 - 7.5	65°C	No	Acetonitrile / Water (80:20)
RP-18 endcapped	L1	Octadecylsilane with endcapping	5, 10	100	1.25	350	21.6	4.09	2 - 7.5	65°C	Yes	Acetonitrile / Water (80:20)
PAH	L1	Octadecylsilane	5	150		200			2 - 7.5	65°C	No	Acetonitrile / Water (80:20)
RP-8	L7	Octylsilane	5, 10	100	1.25	350	12.5	4.04	2 - 7.5	65°C	No	Acetonitrile / Water (80:20)
RP-8 endcapped	L7	Octylsilane with endcapping	5, 10	100	1.25	350	13.0	4.44	2 - 7.5	65°C	Yes	Acetonitrile / Water (80:20)
RP-selectB	L7	Octylsilane deactivated for the separation of basic compounds	5, 10	60	0.9	360	11.5	3.55	2 - 7.5	65°C	No	Acetonitrile / Water (80:20)
Diol	L20	Diol	5, 10	100	1.25	350	8.0	3.87	2 - 7.5	65°C	No	n-Heptane
CN	L10	Cyanosilane	5, 10	100	1.25	350	6.6	3.52	2 - 7.5	65°C	No	n-Heptane
NH2	L8	Aminosilane	5, 10	100	1.25	350	4.6	4.10	2 - 7.5	65°C	No	n-Heptane
Si	L3	unbonded	5, 10	60 100	0.85 1.25	700 400	n.a.	n.a.	2 - 7.5	65°C	N.A.	n-Heptane

Ordering Information

LiChrospher® (5µm)

Length (mm)	I.D. (mm)	RP-18 (5 µm)	RP-18 endcapped (5 µm)	PAH	RP-8 (5 µm)	RP-8 endcapped (5 µm)	RP-select B (5 µm)	Diol (5 µm)	CN (5 µm)	NH2 (5 µm)	Si 60 (5 µm)	Si 100 (5 µm)
LiChroCART® HPLC Cartridge [1 unit; * 3 units]												
25	x 4	1.50931.0001*	1.50936.0001*	on request	1.50930.0001*	on request	1.50937.0001*	on request	on request	on request	on request	on request
75	x 4	1.50987.0001*	on request	on request	on request	on request	1.50993.0001*	on request	on request	on request	on request	on request
100	x 4.6	1.50600.0001	1.50603.0001	on request	1.50634.0001	on request	1.50640.0001	on request	on request	on request	on request	on request
125	x 3	1.50159.0001	on request	on request	on request	on request	1.50158.0001	on request	on request	on request	on request	on request
125	x 4	1.50823.0001	1.50828.0001	on request	1.50822.0001	1.50827.0001	1.50829.0001	1.50826.0001	1.50825.0001	1.50824.0001	1.50820.0001	on request
125	x 4	1.50943.0001*	1.50734.0001*	on request	1.50942.0001*	on request	1.50981.0001*	on request	on request	on request	on request	on request
125	x 4.6	on request	1.51908.0001	on request	on request	on request	on request	on request	on request	on request	on request	on request
150	x 4.6	1.50601.0001	1.50604.0001	on request	1.50635.0001	1.50638.0001	1.50641.0001	on request	on request	on request	on request	on request
250	x 3	1.50154.0001	on request	1.50156.0001	on request	on request	1.50155.0001	on request	on request	on request	on request	on request
250	x 4	1.50833.0001	1.50838.0001	1.50149.0001	1.50832.0001	1.50837.0001	1.50839.0001	1.50836.0001	1.50892.0001	1.50834.0001	1.50830.0001	on request
250	x 4	1.50983.0001*	1.50995.0001*	on request	on request	on request	1.50984.0001*	on request	on request	on request	on request	on request
250	x 4.6	1.50602.0001	on request	on request	1.50636.0001	1.50639.0001	on request	on request	on request	on request	on request	on request
Validation Kits [3 LiChroCART® HPLC cartridges from 3 different sorbent batches]												
100	x 4.6	1.50600.1003	on request	on request	1.50634.1003	on request	1.50640.1003	on request	on request	on request	on request	on request
125	x 3	1.50159.1003	on request	on request	on request	on request	on request	on request	on request	on request	on request	on request
125	x 4	1.50823.1003	on request	on request	1.50822.1003	on request	1.50981.1003	on request	on request	on request	on request	on request
150	x 4.6	on request	1.50604.1003	on request	on request	on request	1.50641.1003	on request	on request	on request	on request	on request
250	x 3	1.50154.1003	on request	on request	on request	on request	1.50155.1003	on request	on request	on request	on request	on request
250	x 4	1.50833.1003	1.50838.1003	on request	1.50832.1003	on request	1.50839.1003	on request	on request	on request	on request	on request
250	x 4.6	1.50602.1003	1.50605.1003	on request	1.50636.1003	on request	1.50642.1003	on request	on request	on request	on request	on request
Guard cartridges LiChroCART® [10 units]												
4	x 4	1.50957.0001	1.50962.0001	1.50148.0001	1.50956.0001	1.50961.0001	1.50963.0001	1.50960.0001	1.50959.0001	1.50958.0001	1.50955.0001	
The LiChroCART® columns (75, 100, 125, 150 and 250 mm length) in the list above (2, 3, 4 and 4.6 mm I.D.) require part number 1.51486.0001 manu-CART® cartridge column holder, which can be used to hold one cartridge column with or without a 4-4 mm guard column. LiChroCART® columns 250-10 mm require part number 1.51419.0001 manu-CART® 10. Additional dimensions and validation kit available as customized packings see page 120.												
Hibar® RT HPLC Column [1 unit]												
100	x 4.6	1.50545.0001	on request	on request	1.50578.0001	1.50581.0001	1.50573.0001	on request	on request	on request	on request	on request
125	x 2	on request	1.51907.0001	on request	on request	on request	on request	on request	on request	on request	on request	on request
125	x 4	1.50477.0001	on request	on request	on request	on request	on request	on request	on request	on request	on request	on request
125	x 4.6	on request	on request	on request	on request	on request	on request	on request	on request	on request	on request	on request
150	x 4.6	1.50546.0001	1.50549.0001	on request	1.50579.0001	1.50582.0001	1.50574.0001	on request	on request	1.51905.0001	on request	on request
250	x 4	1.50377.0001	on request	on request	1.50329.0001	on request	on request	on request	on request	on request	on request	1.50316.0001
250	x 4.6	1.50547.0001	1.50550.0001	on request	1.50580.0001	1.50583.0001	1.50575.0001	on request	on request	1.51904.0001	on request	on request
Validation Kits [3 Hibar® RT HPLC Columns from 3 different sorbent batches]												
100	x 4.6	1.50545.1003	on request	on request	1.50578.1003	on request	1.50573.1003	on request	on request	on request	on request	on request
125	x 4	1.50477.1003	on request	on request	on request	on request	on request	on request	on request	on request	on request	on request
150	x 4.6	on request	1.50549.1003	on request	on request	on request	1.50574.1003	on request	on request	on request	on request	on request
250	x 4	1.50377.1003	on request	on request	1.50329.1003	on request	on request	on request	on request	on request	on request	on request
240	x 4.6	on request	1.50550.1003	on request	on request	on request	on request	on request	on request	on request	on request	on request
The Hibar® columns are complete with endittings. When using a guard column with a Hibar® column, we recommend part number 1.51487.0001 guard column cartridge holder for 4-4 mm guard column cartridges LiChroCART®. Additional dimensions available as customized packings see page 120.												
Stainless steel ready to use HPLC Column SIAL												
150	x 3.2	54775										
250	x 3.2	54777								54785		
125	x 4				50141-U		50146-U					
250	x 4	50137-U										
125	x 4.6				50140-U							
150	x 4.6	54774			54778					54782	54790-U	
250	x 4.6	54776			54780					54788	54792	
SupelGuard™ Column SIAL												
10	x 4.6	54794								54798	54797-U	
LiChrospher® - Bulk Sorbents												
10 g Sorbent in glass bottle		1.16177.0010	1.19637.0010		1.16129.0010	1.19636.0010	1.19641.0010	1.16152.0010	1.19638.0010		1.19640.0010	

HPLC Columns "on request" are available as Custom Product. Please see page 120/121

Superspher® HPLC Columns

Classical silica carrier for highly efficient separations

Superspher®, a spherical silica carrier with a mean particle size of 4 µm, providing higher separation performance in HPLC Applications. The number of theoretical plates for Superspher® is approx. 100,000 N/m. Thus, Superspher® HPLC columns are a good choice when complex mixtures demand high peak capacity. A broad range of modifications on Superspher® is available: non-polar derivatives (RP-8, RP-8 endcapped, RP-18, RP-18 endcapped and RP-select B) and polar derivatives (Si 60).

Phase Bonding	USP Designation	Bonding Chemistry	Particle Size (µm)	Pore Size (Å)	Pore volume (mL/g)	Surface Area (m²/g)	Carbon Load (%)	Surface Coverage (µmol/m²)	pH Stability	Max Temperature	Endcapped
RP-18	L1	Octadecylsilane	4	100	1.25	350	21.0	3.61	2 - 7.5	65 °C	No
RP-18 endcapped	L1	Octadecylsilane	4	100	1.25	350	21.6	4.09	2 - 7.5	65 °C	Yes
RP-8	L7	Octylsilane	4	60	1.25	350		4.04	2 - 7.5	65 °C	No
RP-8 endcapped	L7	Octylsilane	4	60	1.25	350	13.0	4.44	2 - 7.5	65 °C	Yes
RP-select B	L7	Octylsilane deactivated for the separation of basic compounds	4	60	0.9			3.55	2 - 7.5	65 °C	No
Si	L3	unbonded	4	60	0.85	700	n.a.	n.a.	2 - 7.5	65°C	N.A.

Superspher® packing materials are available as LiChroCART® cartridges in various lengths and internal diameters (4.6 mm, 4 mm, 3 mm and 2 mm). LiChroCART® 3 mm I.D. and 2 mm I.D. narrow bore cartridges for HPLC save costs by reducing solvent consumption and allow the handling of very small quantities with excellent sensitivity and resolution. LiChroCART® cartridges 4.6 mm, 4 mm I.D., 3.9 mm I.D., 3 mm I.D. and 2 mm I.D. are compatible with manu-CART® "4". This facilitates faster and more flexible method adaptation to smaller bore columns.

Ordering Information

Superspher® (4 µm)

Column dimension							
Length (mm)	I.D. (mm)	RP-18	RP-18 endcapped	RP-8	RP-8 endcapped	RP-select B	Si
LiChroCART® HPLC Cartridge [1 unit; * 3 units]							
25	x 4	1.16039.0001*	1.16869.0001*	on request	on request	on request	on request
30	x 3	on request	on request	on request	on request	on request	on request
75	x 4	1.50980.0001*	on request	on request	on request	1.50974.0001*	on request
125	x 2	on request	1.50198.0001	on request	on request	1.50197.0001	on request
125	x 3	1.50792.0001	1.51909.0001	on request	on request	1.50791.0001	on request
125	x 4	1.16051.0001	1.16855.0001	1.16052.0001	1.16854.0001	1.50975.0001	1.16054.0001
150	x 4.6	on request	on request	on request	on request	on request	on request
250	x 2	on request	1.50193.0001	on request	on request	1.51308.0001	on request
250	x 3	1.51299.0001	1.51910.0001	on request	on request	1.51288.0001	on request
250	x 4	1.16056.0001	1.16858.0001	1.16010.0001	1.16857.0001	1.50973.0001	1.16009.0001
250	x 4.6	on request	on request	on request	on request	on request	on request
Validation Kits [3 LiChroCART® HPLC cartridges from 3 different sorbent batches]							
125	x 2	on request	on request	on request	on request	on request	on request
125	x 3	on request	on request	on request	on request	on request	on request
125	x 4	1.16051.1003	on request	on request	on request	on request	on request
250	x 3	1.51299.1003	on request	on request	on request	on request	on request
250	x 4	on request	on request	on request	on request	on request	on request
Guard cartridges LiChroCART® [3 units]							
10	x 2	on request	on request	on request	on request	on request	on request
Superspher® - Bulk Sorbents							
10 g Sorbent in glass bottle		1.19613.0010		1.19612.0010		1.19643.0010	

The LiChroCART® columns (75, 125, 150 and 250 mm length) in the list on the left (2, 3, 4 and 4.6 mm I.D.) require part number [1.51486.0001](#) manu-CART® cartridge column holder, which can be used to hold one cartridge column with or without a 4-4 mm guard column. Additional dimensions available as customized packings see page 120. As guard column we recommend LiChroCART® 4-4 LiChrospher® guard cartridges.

LiChrosorb® HPLC Columns

Irregular shaped silica sorbent

LiChrosorb® is one of the most successful and reliable packing materials, used in HPLC for decades and documented in the literature in the form of several thousand applications. The totally porous, irregular particles are finely graded in the 5 and 10 µm range.

LiChrosorb® packing materials offer the complete program of non-polar (RP-8, RP-18, RP-select B) and polar modifications (Si 60 and Si 100). In addition to the analytical cartridges and columns, such as LiChroCART® 250-4 or Hibar® RT 250-4, we offer semi-preparative cartridges LiChroCART® 250-10 as well as Hibar® RT columns 250-10, packed on request with various LiChrosorb® packing materials.

LiChrosorb® HPLC column can be easily replaced with LiChrospher® spherical fully porous particulate columns. For further improvements in resolution, column efficiency and peak symmetry as well as for fast and UHPLC applications, we recommend alternatives based on more advanced Type B silica column technology.

Ordering Information

LiChrosorb®

Column dimension							
Length (mm)	I.D. (mm)	RP-18 (5 µm)	RP-18 (10 µm)	RP-8 (5 µm)	RP-8 (10 µm)	Si 60	Si 100
LiChroCART® HPLC Cartridge [1 unit]							
125	x 4	1.51349.0001	on request	1.51345.0001	on request	on request	1.51343.0001
250	x 4	1.51355.0001	1.51356.0001	1.51353.0001	1.51354.0001	on request	1.51351.0001

The LiChroCART® columns (125, and 250 mm length) in the list above (2, 3, 4 and 4.6 mm I.D.) require part number [1.51486.0001](#) manu-CART® cartridge column holder, which can be used to hold one cartridge column with or without a 4-4 mm guard column. LiChroCART® columns 250-10 mm require part number [1.51419.0001](#) manu-CART® 10. Additional dimensions and validation kit available as customized packings see page 120.

Hibar® RT HPLC Column [1 unit]

125	x 4	1.50433.0001	on request	1.50432.0001	on request	on request	on request
125	x 4.6	on request	on request	1.50012.7057	on request	on request	on request
250	x 4	1.50333.0001	1.50334.0001	1.50332.0001	1.50318.0001	1.50388.0001	on request
250	x 3	on request	on request	on request	on request	on request	on request
250	x 4.6	1.51902.0001	on request	1.51903.0001	on request	on request	on request

The Hibar® columns are complete with endittings. When using a guard column with a Hibar® column, we recommend part number [1.51487.0001](#) guard column cartridge holder for 4-4 mm guard column cartridges LiChroCART®. Additional dimensions available as customized packings see page 120.

LiChrosorb® - Bulk Sorbents

10 g Sorbent in glass bottle	1.09333.0010	1.09318.0010	1.09309.0010
------------------------------	------------------------------	------------------------------	------------------------------

Stainless steel ready to use HPLC Column SIAL

150	x 3.2	54952	
125	x 4		57484-U
100	x 4.6	50124-U	
150	x 4.6	54951	54955-U
200	x 4.6		50125-U
250	x 4.6	54949	54953-U

SupelGuard™ SIAL

10	x 4.6	54965-U	54966
----	-------	-------------------------	-----------------------

HPLC Columns "on request" are available as Custom Product. Please see page 120/121

SUPELCOSIL™ HPLC Columns

Our SUPELCOSIL™ silica-based HPLC column line includes many phase chemistries, in a range of particle sizes and column configurations from microbore to preparative scale. This product line is the original high quality Supelco® product line referenced in many USP methods.

For improvements in resolution, column efficiency and peak symmetry as well as for fast and UHPLC applications, we recommend alternatives based on more advanced column technology such as Type B silica, Superficially Porous Particles or monolithic columns.

Phase Bonding	USP Designation	Bonding Chemistry	Chromatographic Properties / Use	Particle Size (µm)	Pore Size (Å)	Surface Area (m ² /g)	Carbon Load (%)	Surface Coverage (µmol/m ²)	pH Stability	Max Temperature	Endcapped
LC-18	L1	Octadecyl	General-purpose hydrophobic alkyl phase suitable for a variety of compounds.	3, 5	120	170	11	3.1	2 - 7.5	70	yes
LC-18-DB	L1	Octadecyl	C18-DB phases are specially deactivated for the separation of basic compounds providing improved peak shape.	3, 5	120	170	11	3.1	2 - 7.5	70	yes
LC-18-T	L1	Octadecyl	C-18-T columns feature an octadecylsilane bonded phase and a special surface treatment for efficient separations of nucleotides.	3, 5	120	170	12.3	3.1	2 - 7.5	70	yes
LC-18-S	L1	Octadecyl	C-18-S columns are designed for reliable separations of deoxyribonucleosides and ribonucleosides.	5	120	170	11	3.1	2 - 7.5	70	yes
LC-8	L7	Octyl	C8 phases are less hydrophobic than C18 and provides less retention of both polar and non-polar compounds than C18.	3, 5	120	170	6	3.2	2 - 7.5	70	yes
LC-8-DB	L7	Octyl	C8-DB phases are specially deactivated for basic compounds providing improved peak shape.	3, 5	120	170	6	3.2	2 - 7.5	70	yes
LC-1 Methyl	L13	Methyl	Due to a mixed retention mechanism, selectivity differences for polar groups are more pronounced than on C8 and C18 columns.	5	120	170	2	3.4	2 - 7.5	70	yes
LC-DP Diphenyl	L11	Diphenyl	Diphenyl bonded phase, which gives greater selectivity for aromatic groups compared to alkyl-type bonded phases.	5	120	170	6	2.4	2 - 7.5	70	yes
LC-ABZ	L60	Alkylamide	This deactivated phase provides enhanced reversed-phase performance for basic compounds, as well as those that are acidic, polar neutral, and non-polar.	5	120	170	12	3.4	2 - 7.5	70	yes
ABZ+Plus	L60	Alkylamide	SUPELCOSIL™ ABZ+Plus HPLC columns offer both high deactivation and unique selectivity allowing the use of low ionic strength buffers without having to add an ion-suppressing modifier.	3, 5	120	170	12	3.4	2 - 7.5	70	yes
Suplex™ pKb-100	L68	Alkylamide	Suplex pKb-100 columns are not end-capped, but feature the same bonded phase functionality as SUPELCOSIL™ LC-ABZ columns. The absence of end-capping reagent results in better performance for the strongest basic compounds, while LC-ABZ is preferred when the sample also contains acids and zwitterions.	5	120	170	12.5	3.4	2 - 7.5	70	Yes
LC-CN	L10	Cyano	The LC-CN phases are suitable for operation under reversed-phase conditions (HILIC) as well as under normal phase conditions.	3, 5	120	170	4	3.5	2 - 7.5	70	yes
LC-Diol	L20	Diol	LC-Diol columns can be used to separate proteins by gel filtration chromatography. They are suitable for operation under reversed-phase conditions (HILIC) as well as under normal phase conditions.	5	120	170	3.5	3.8	2 - 7.5	70	no
LC-NH2	L8	Amino	The amino column is most often employed for the separation of mono- and disaccharides. As a normal-phase application, amino columns are used in the petroleum industry	3, 5	120	170	3	5.1	2 - 7.5	70	no
LC-Si	L3	Silica	Non-polar compounds elute first on a normal phase silica column, while polar compounds elute late. LC-Si columns can operate in normal phase mode as well as in HILIC mode.	3, 5	120	170	n.a.	n.a.	2 - 7.5	70	n.a.
LC-SCX	L52	Sulfonic acid; strong cation exchanger	The LC-SCX cation-exchange columns have strongly acidic propylsulfonic acid groups and are used for separating cations.	5	120	170	n.a.	n.a.	2 - 7.5	70	n.a.
SAX1	L14	propyltrimethylammonium phase	SAX1 HPLC Column is typically employed as an anion exchange column with strongly basic quaternary aminopropyl phase and is used for separating anions.	5	120	170	12	n.a.	2 - 7.5	70	n.a.

Ordering Information

SUPELCOSMSIL™ (5 µm)

Length (mm)	I.D. (mm)	LC-18	LC-18-DB	LC-18-T	LC-18-S	LC-PAH	LC-8	LC-8-DB	LC-1 Methyl	LC-DP Diphenyl	LC-ABZ Alkylamide	ABZ+Plus Alkylamide	Suplex™ pKb-100 Alkylamide	LC-CN	LC-Diol	LC-NH2	LC-Si	LC-SCX	SAX1	
50	x	2.1	on request	on request	on request	on request	on request	on request	on request	on request	on request	on request	on request	on request	on request	on request	on request	on request	on request	
100	x	2.1	on request	on request	on request	on request	on request	on request	on request	on request	on request	on request	on request	on request	on request	on request	on request	on request	on request	
150	x	2.1	57934	on request	on request	on request	on request	on request	on request	on request	on request	on request	on request	on request	on request	on request	on request	on request	on request	
250	x	2.1	57935	57940	on request	57939	on request	on request	on request	on request	on request	on request	on request	on request	on request	on request	57930-U	on request	on request	
50	x	3	on request	on request	on request	on request	on request	on request	on request	on request	on request	on request	on request	on request	on request	on request	on request	on request	on request	
100	x	3	on request	on request	on request	on request	on request	on request	on request	on request	on request	on request	on request	on request	on request	on request	on request	on request	on request	
150	x	3	58230C30	on request	on request	on request	on request	on request	on request	on request	on request	on request	on request	on request	on request	on request	on request	on request	on request	
250	x	3	58298C30	on request	on request	on request	59187	on request	on request	on request	on request	59142C30	59197C30	58934C30	on request	58201C30	58338C30	on request	58997C30	
30	x	4	on request	on request	on request	on request	on request	on request	on request	on request	59167	on request	on request	on request	on request	on request	on request	on request	on request	
50	x	4	58239C40	on request	on request	on request	on request	on request	on request	on request	on request	on request	on request	on request	on request	on request	on request	on request	on request	
150	x	4	58230C40	58348C40	on request	on request	on request	58220C40	58347C40	on request	on request	on request	on request	on request	on request	on request	on request	on request	on request	
250	x	4	58298C40	on request	on request	on request	on request	58354C40	on request	on request	on request	59142C40	59197C40	58934C40	on request	58201C40	58338C40	on request	on request	
300	x	4	59165	59164	on request	on request	on request	on request	on request	on request	on request	on request	on request	on request	on request	on request	on request	on request	on request	
50	x	4.6	58239	58345	on request	on request	on request	58238	58344	on request	on request	59141	on request	on request	on request	on request	on request	on request	on request	
100	x	4.6	59209	on request	on request	on request	on request	on request	on request	on request	on request	59211	on request	on request	on request	on request	on request	on request	on request	
150	x	4.6	58230-U	58348	on request	58931	58318	58220-U	58347	on request	59150-U	59140-U	59196	58932	58221-U	on request	on request	58200-U	on request	
250	x	4.6	58298	58355-U	58971	58928-U	58229	58297	58354	58296	58842	59142	59197	58934	58231	58201	58338	on request	58997	59138
250	x	10	58368	58358	on request	on request	on request	58367	on request	on request	on request	on request	59179	59172	on request	on request	on request	on request	on request	
100	x	21.2	on request	on request	on request	on request	on request	on request	on request	on request	on request	on request	on request	on request	on request	on request	on request	on request	on request	
250	x	21.2	57935	on request	on request	on request	on request	on request	on request	on request	on request	on request	54855	on request	on request	on request	on request	on request	on request	
SUPELCOSMSIL™ Supelguard™ Guard Cartridge (2 pack)																				
20	x	2.1	59613	59617	on request	59162	59613	59615	on request	on request	on request	59611	59605	on request	on request	on request	on request	on request	on request	
20	x	3	59564C30	on request	59621C30	on request	59564C30	on request	59563C30	on request	on request	on request	on request	on request	on request	on request	59568C30	on request	on request	
20	x	4	59564	59565	59621	59630	59564	59562	59563	59561	on request	59566	59545-U	59535-U	59541-U	59567	59569	59568	on request	59519
SUPELCOSMSIL™ Supelguard™ Guard Kit (Guard cartridge, stand-alone holder, tubing, 2 nuts and ferrules)																				
20	x	4	59554	59555	59620	59629	59554	59552	59553	on request	on request	59556	59544-U	59534-U	59531-U	59557	59559	59558	on request	59509

HPLC Columns "on request" are available as Custom Product. Please see page 120/121

SUPELCOSMSIL™ (3 µm)

Length (mm)	I.D. (mm)	LC-18	LC-18-DB	LC-18-T	LC-8	LC-8-DB	ABZ+Plus Alkylamide	LC-CN	LC-NH2	LC-Si	
33	x	2.1	on request	57943	on request	on request	58149-U	on request	on request	on request	
100	x	2.1	on request	on request	on request	on request	57917	on request	on request	on request	
250	x	2.1	57942	57943	on request	on request	on request	on request	on request	on request	
33	x	3	on request	58978C30	on request	58975C30	on request	58979C30	on request	on request	
50	x	3	on request	on request	on request	on request	on request	on request	on request	on request	
75	x	3	on request	on request	on request	58982C30	58990C30	on request	58986C30	on request	
150	x	3	58985C30	58993C30	58970C30	on request	on request	59194C30	on request	58989C30	58981C30
75	x	4	58984C40	on request	on request	on request	on request	on request	on request	on request	
150	x	4	58985C40	on request	on request	on request	58991C40	on request	on request	on request	
33	x	4.6	58977	58978	on request	58975	58976	on request	58979	on request	
50	x	4.6	58973	on request	on request	on request	on request	on request	on request	on request	
75	x	4.6	58984	58992	on request	58982	58990-U	on request	58986	58988	on request
150	x	4.6	58985	58993	58970-U	58983	58991	59194	on request	58989	58981

HPLC Columns "on request" are available as Custom Product. Please see page 120/121

Chiral HPLC Columns

HPLC Chiral Stationary Phases

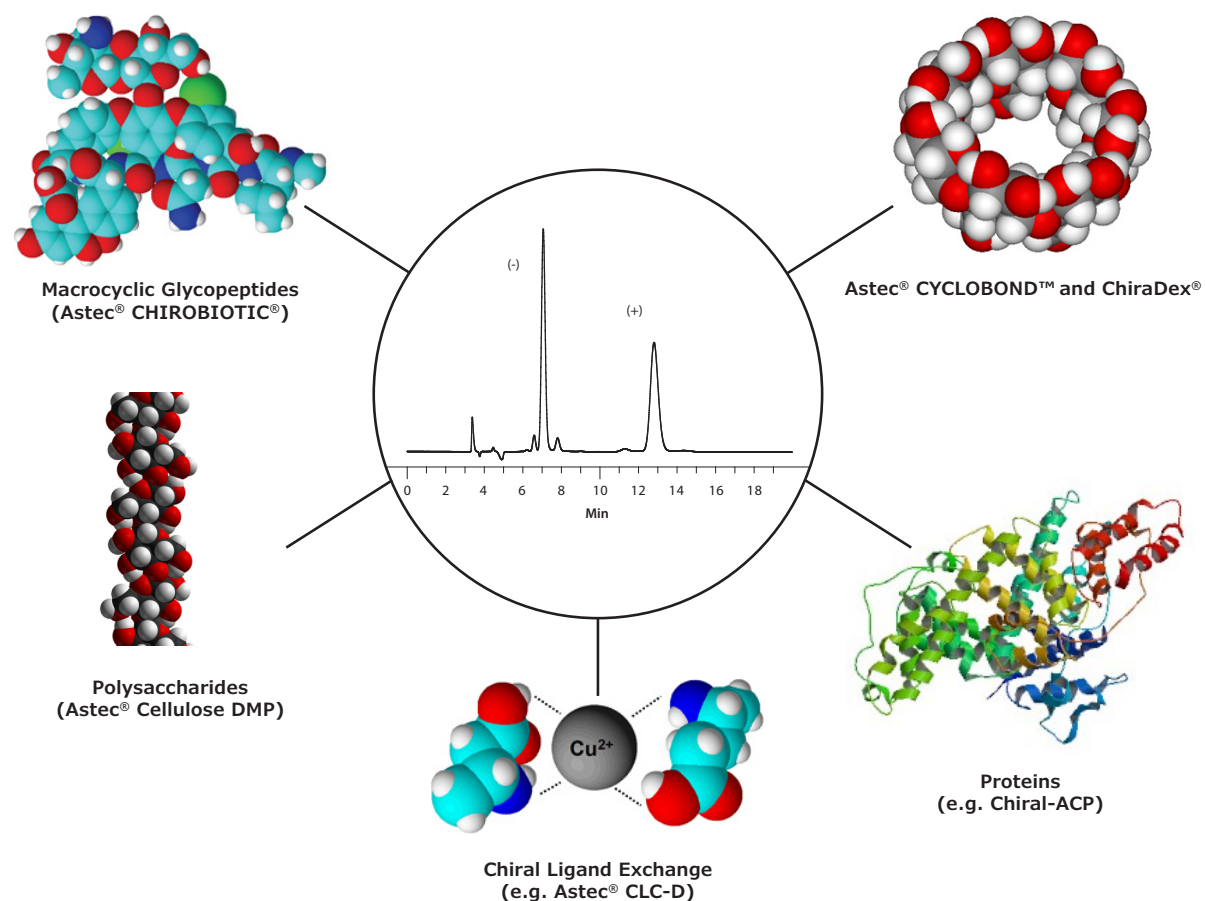

Chirality belongs to the discipline of stereochemistry, which is the study of the three-dimensional structure of molecules. Chiral compounds are optically active, that means they rotate polarized light to the left or to the right depending on their configuration. The word comes from the Greek stem "chir-" meaning hand, for handedness. Chiral molecules are like left and right hands – they are mirror images. With no amount of rotation can you make the two images or molecules overlap. A chiral compound will rotate the plane of polarized light; the degree to which it does this is called the specific rotation or optical rotation.

Besides the fact that one enantiomer is often safer and more efficacious than the other enantiomer, there are other arguments for having optically pure compounds. (1) Dosing is lower. If the product contains unwanted or inactive enantiomer, then they need to dose twice as much than they would if clinicians had only the pure active enantiomer. (2) No interference of the desired

activity by the unwanted enantiomer. In many cases, the unwanted enantiomer will have different biological activity (e.g. toxic or harmful) and will interfere with the performance of the intended enantiomer. (3) Time savings in testing. If the product contains more than one enantiomer, the biological activity of each isomer plus the racemate needs to be checked. This is three times the work than testing the pure enantiomer! These arguments are true for other industries besides pharmaceutical, for example agrochemicals. This aspect has environmental implications as it can affect the total amount of chemical applied to the crop.

The Supelco® line of chiral columns offers a broad portfolio of columns that can be used in reversed-phase mode, normal phase mode, polar organic mode, and polar ionic mode. In addition, these columns are economically priced compared to other vendors' chiral columns and we offer complete scalability from analytical to prep.

CHIROBIOTIC® Chiral HPLC Columns

CHIROBIOTIC® phases are based on covalently bonding macrocyclic glycoproteins to a high purity 5 µm silica gel in such a way as to establish its stability while retaining essential components for chiral recognition. CHIROBIOTIC® V and V2 are based on bonding Vancomycin, which contains 18 chiral centers surrounding three pockets or cavities. Five aromatic ring structures bridge these strategic cavities. Hydrogen donor acceptor sites are readily available close to the ring structures. CHIROBIOTIC® V has demonstrated selectivity similar to glycoprotein phases except it is stable from 0-100% organic modifier and exhibits high sample capacity.

For CHIROBIOTIC® V2, changes to the linkage chemistry and silica offer improvements for preparative LC and for more demanding chiral separations. CHIROBIOTIC® T, T2, and TAG are based on bonding the amphoteric glycopeptide, Teicoplanin, which contains 23 chiral centers surrounding four pockets or cavities. For CHIROBIOTIC® T2, changes to the linkage chemistry and silica offer improvements for preparative LC and for more demanding chiral separations. CHIROBIOTIC® TAG has the sugars removed from the macrocyclic glycopeptide to produce an aglycone structure as a variant of CHIROBIOTIC® T. CHIROBIOTIC® R is based on bonding Ristocetin A to high purity 5 µm silica.

LC-MS of Fluoxetine Enantiomers on CHIROBIOTIC® V2: Fast, Sensitive Analysis on Short, Narrow I.D. Columns

Column:	CHIROBIOTIC® V2, 25 cm x 4.6 mm or 10 cm x 2.1 mm I.D. 5 µm
Mobile Phase:	10 mM ammonium formate in 10:90 v/v water:methanol
Flow Rate:	1.0 or 0.2 mL/min
Temperature:	ambient
Detection:	+ESI, m/z 310
Injection:	2 µL
Sample:	5 µg/mL in methanol

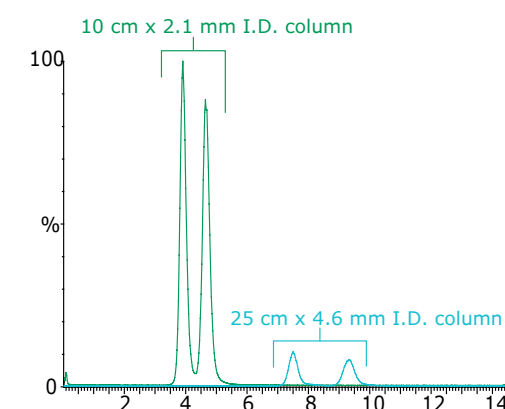

LC-MS of Fluoxetine Enantiomers on CHIROBIOTIC® V2: Use Column Dimensions and Flow Rate to Enhance Sensitivity without Loss of Resolution

Column:	CHIROBIOTIC® V2, 25 cm x 4.6 mm or 10 cm x 2.1 mm I.D., 5 µm
Mobile Phase:	10 mM ammonium formate in 10:90 v/v water:methanol
Flow Rate:	1.0 or 0.1 mL/min
Temperature:	ambient
Detection:	+ESI, m/z 310
Injection:	2 µL
Sample:	5 µg/mL in methanol

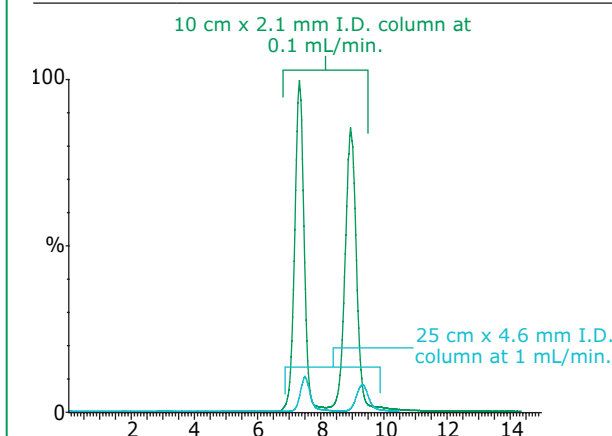

CHIROBIOTIC® (5 µm)

Length (mm)	I.D. (mm)	V	V2	T	T2	TAG	R
100	x 2.1	11018AST	15018AST	12018AST	16018AST	14018AST	on request
150	x 2.1	11019AST	15019AST	12019AST	16019AST	14019AST	13019AST
250	x 2.1	11020AST	15020AST	12020AST	on request	14020AST	13020AST
100	x 3.0	on request	on request	12010AST	on request	on request	on request
50	x 4.6	on request	on request	12021AST	on request	on request	on request
100	x 4.6	11022AST	15022AST	12022AST	on request	14022AST	13022AST
150	x 4.6	11023AST	15023AST	12023AST	16023AST	14023AST	13023AST
250	x 4.6	11024AST	15024AST	12024AST	16024AST	14024AST	13024AST
250	x 10	11034AST	on request	12034AST	on request	14034AST	on request
250	x 21.2	11044AST	15044AST	on request	on request	14044AST	on request
Guard 20	x 1.0	11101AST	15101AST	12101AST	on request	on request	13101AST
Guard 20	x 4.0	11100AST	15100AST	12100AST	on request	14100AST	on request
Guard Holder	x	21150AST					

CYCLOBOND™ Chiral HPLC Columns

CYCLOBOND™ is the name given to Supelco® technology for bonding cyclodextrins to a high purity silica gel through a stable ether linkage. Introduced in 1983, this patented stationary phase has the ability to form inclusion complexes for a wide variety of organic molecules into the cyclodextrin cavities leading to numerous chiral separations. CYCLOBOND™ I are bonded β-cyclodextrins and CYCLOBOND™ II are bonded γ-cyclodextrins.

CYCLOBOND™ I 2000 series of HPLC columns is specially formulated to meet today's stringent requirements for analysis in the pharmaceutical industry, and for small analytes of general interest in chemical and environmental areas. We have focused on the need to accurately and reproducibly separate enantiomers. The result is a high performance

range of chiral separation phases with guaranteed batch to batch reproducibility, greater stability and improved selectivity and resolution. Based on the original CYCLOBOND™ I (β-cyclodextrin) columns, the CYCLOBOND™ I 2000 series are second-generation products. The native β-cyclodextrin and eight β-cyclodextrin derivatives are in the CYCLOBOND™ I 2000 series.

CYCLOBOND™ II series columns are excellent chiral selectors for multi-ring structures such as those based on anthracene, chrysene or pyrene. These are γ-cyclodextrin bonded phases, and consist of eight glucopyranose units arranged in the same truncated cone shape. Applications include steroids, porphorins, and Fmoc amino acids.

Positional Isomers (Xylenes) on CYCLOBOND™ I 2000

Column:	CYCLOBOND™ I 2000, 25 cm x 4.6 mm I.D., 5 μm (20024AST)
Mobile phase	A: acetonitrile B: water
Mobile phase ratio:	15:85 (A:B)
Flow rate:	0.8 mL/min
Temp.:	45 °C
Det.:	UV, 230 nm
Injection:	3 μL
Sample:	each compound, 0.1 mg/mL in acetonitrile:water (50:50)
Elution order:	m-, o-, p-xylene

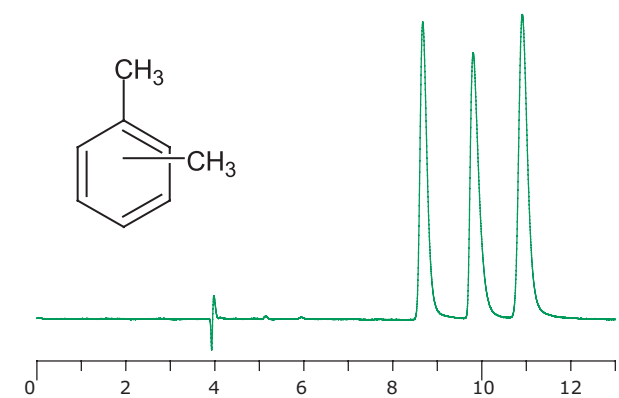

Norgestrel on CYCLOBOND™ II

Column:	CYCLOBOND™ II, 25 cm x 4.6 mm I.D., 5 μm (41020AST)
Mobile phase	A: water B: acetonitrile
Mobile phase ratio:	70:30 (A:B)
Flow rate:	0.8 mL/min
Temp.:	42 °C
Det.:	UV, 254 nm
Injection:	1 μL
Sample:	norgestrel, 1 mg/mL in methanol

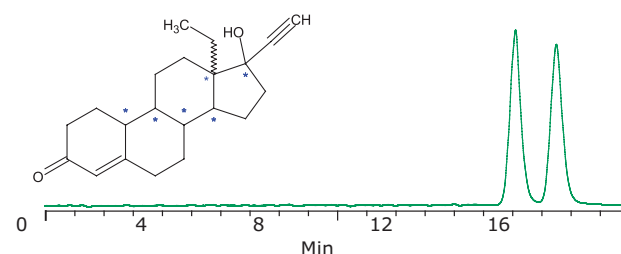

CYCLOBOND™ (5.0 μm)

Length (mm)	I.D. (mm)	I 2000	I 2000 AC	I 2000 SP	I 2000 RSP	I 2000 HP RSP	I 2000 DMP	II
100	x 2.1	20018AST	on request	on request	on request	on request	on request	on request
150	x 2.1	20019AST	on request	on request	on request	on request	on request	on request
100	x 4.6	on request	on request	on request	on request	on request	20722AST	on request
150	x 4.6	on request	20123AST	on request	on request	24023AST	on request	46023AST
250	x 4.6	20024AST	20124AST	20224AST	20324AST	24024AST	20724AST	41020AST
250	x 10.0	20034AST	on request	on request	on request	on request	20734AST	on request
250	x 21.2	on request	on request	on request	on request	on request	20744AST	on request
Guard 20	x 4.0	on request	on request	on request	21103AST	on request	on request	on request
Guard Holder					21150AST			

Cellulose DMP Chiral HPLC Columns

Cellulose DMP is a chiral stationary phase (CSP) comprising spherical, high-purity porous silica coated with DMPC (3,5-dimethylphenyl carbamate)-derivatized cellulose, and packed in analytical to preparative size HPLC columns. It separates a wide range of chiral compounds under normal phase, polar organic, and SFC conditions, with high efficiency, high loading capacity, and excellent column lifetime. Performance is comparable to other DMPC-derivatized cellulose CSPs.

Key Features and Application Areas:

- Classic DMPC-cellulose chiral selectivity
- Efficient, rugged, reproducible, and scalable
- Low backpressure
- Ideal for chiral analysis in the pharmaceutical industry and for small analytes in chemical and environmental areas
- Routine chiral column method development screening protocols
- Approximately half of the cost of most other DMPC-cellulose columns

Cellulose DMP is complementary to the other CSPs, including CHIROBIOTIC® and CYCLOBOND™ product lines, and a must-have for every chiral HPLC or SFC screening protocol.

Cellulose DMP (5.0 μm)

Length (mm)	I.D. (mm)	SKU
150	x 2.1	51100AST
100	x 4.6	on request
150	x 4.6	51098AST
250	x 4.6	51099AST
Guard 20	x 2.1	51104AST
Guard 20	x 4.0	on request

Copper Ligand Exchange (CLC) Chiral HPLC Columns

The CLC phases are based on coupling an enantiomeric form of an amine to a proprietary derivative to create an appropriate distance for copper coupling. Using the copper ligand concept, this phase resolves hydroxy acids like lactic, malic, tartaric and mandelic. This phase can also resolve amino acids and other amines by the same mechanism. It has been reported that, in addition to amino acids, other bifunctional racemates like amino alcohols can be resolved. In theory, any analyte that can complete the coordination with the copper ion can be resolved. For the CLC-D column, the L enantiomer generally elutes before D with the exception of tartaric acid where the D elutes first. The CLC-L column has the opposite elution order and the D enantiomer elutes before L.

Copper Ligand Exchange (5.0 μm)

Length (mm)	I.D. (mm)	CLC-D	CLC-L
150	x 4.6	53023AST	53123AST

Protein-Based Chiral HPLC Columns

Hermansson described the use of natural proteins immobilized onto a silica support for chiral separations in 1983. Proteins contain a large number of chiral centers of one configuration, and many other sites that contribute to the general retention process. We offer three CSPs with proteins as the chiral selectors, CHIRALPAK® AGP (α1-acid glycoprotein), CHIRALPAK® CBH (cellobiohydrolase) and CHIRALPAK® HSA (human serum albumin). All are manufactured by DAICEL Corporation. These columns are typically used in reversed-phase mode, and perform a wide variety of chiral separations. CHIRALPAK® HSA is also used for drug-binding studies. Solute retention is retained by three types of interactions: ionic (for charged solutes), hydrophobic and hydrogen bonding. The relative contribution of the different forces to solute retention depends on the nature of the analyte.

- CHIRALPAK® AGP: Extremely broad applicability. First choice when developing methods on protein-CSPs.
- CHIRALPAK® HSA: Analytes are typically very hydrophilic acids.
- CHIRALPAK® CBH: Analytes are typically very hydrophilic amines and amino alcohols.

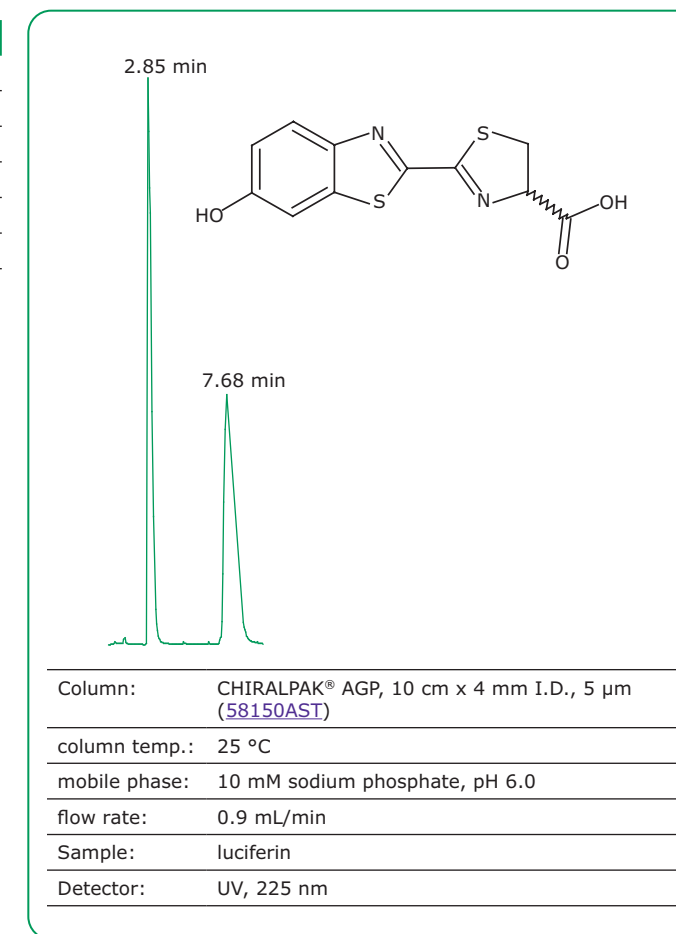

CHIRALPAK® (5.0 µm)

Length (mm)	I.D. (mm)	AGP	CBH	HSA
50	x 2.0	58129AST	on request	on request
100	x 2.0	58130AST	58530AST	58430AST
150	x 2.0	58131AST	58531AST	on request
50	x 3.0	58169AST	58569AST	58469AST
100	x 3.0	58170AST	58570AST	58470AST
150	x 3.0	58171AST	58571AST	on request

Length (mm)	I.D. (mm)	AGP	CBH	HSA
50	x 4.0	on request	58549AST	58449AST
100	x 4.0	58150AST	58550AST	58450AST
150	x 4.0	58151AST	58551AST	58451AST
Coupler for Legacy Guard Column Holder: 54986				
Guard Column Holder: 58159AST				

ES Industries ChromegaChiral™ U/HPLC Columns

ChromegaChiral™ Columns, manufactured by ES Industries, are innovative chiral stationary phases designed for unique chiral solutions. ES Industries is a recognized supplier of chiral HPLC columns providing highly efficient columns with superior reproducibility. These columns are available in 3, 5, and 10 µm analytical and preparative sizes. Abbreviations: CCA = tris-(3,5-di- methylphenyl) carbamoyl amylose; CCC = 3-chloro-4 methylphenylcarbamate and 3,5-dichloro- phenylcarbamate on cellulose; CCJ = cellulose 4-methylbenzoate; CCO = tris-(3,5-di-methylphenyl) carbamoyl cellulose; CCO F2 = 2-Fluoro 5-methylphenyl cellulose; CCO F4 = 4-Fluoro 3-methylphenyl cellulose; CCS = amylose tris [(S)-α-methylbenzylcarbamate]; CC2 = cellulose 3-chloro-4 methylphenyl-carbamate; CC3 = amylose tris(5-chloro-2-methyl- phenylcarbamate; CC4 = cellulose tris(4-chloro-3-methyl-phenylcarbamate

ChromegaChiral™ (3.0 µm)

Length (mm)	I.D. (mm)	CCA	CCC	CCJ	CCO	CCO F2	CCO F4	CCS	CC2	CC3	CC4
50	x 2.1					ES5540	ES5573				
100	x 2.1	ES5395	ES5441	ES5474	ES5507	ES5543	ES5576	ES5606	ES5639	ES5672	ES5704
150	x 2.1	ES5398	ES5444	ES5477	ES5510	ES5546	ES5579	ES5609	ES5642	ES5674	ES5707
250	x 2.1	ES5401	ES5447	ES5480	ES5513			ES5612	ES5645	ES5677	ES5710
50	x 3.0					ES5541	ES5574				
100	x 3.0	ES5396	ES5442	ES5475	ES5508	ES5544	ES5577	ES5607	ES5640		ES5705
150	x 3.0	ES5399	ES5445	ES5478	ES5511	ES5547	ES5580	ES5610	ES5643	ES5675	ES5708
250	x 3.0	ES5402	ES5448	ES5481	ES5514			ES5613	ES5646	ES5678	ES5711
50	x 4.6					ES5542	ES5575				
100	x 4.6	ES5397	ES5443	ES5476	ES5509	ES5545	ES5578	ES5608	ES5641	ES5673	ES5706
150	x 4.6	ES5400	ES5446	ES5479	ES5512	ES5548	ES5581	ES5611	ES5644	ES5676	ES5709
250	x 4.6	ES5403	ES5449	ES5482	ES5515			ES5614	ES5647	ES5679	ES5712

ChromegaChiral™ (5.0 µm)

Length (mm)	I.D. (mm)	CCA	CCA F4	CCC	CCJ	CCO	CCO F2	CCO F4	CCS	CC2	CC3	CC4
100	x 2.1	ES5404	ES5428	ES5450	ES5483	ES5516	ES5549	ES5582	ES5615	ES5648	ES5680	ES5713
150	x 2.1	ES5407	ES5431	ES5453	ES5486	ES5519	ES5552	ES5585	ES5618	ES5651	ES5683	ES5716
250	x 2.1	ES5411	ES5435	ES5457	ES5490	ES5523	ES5556	ES5589	ES5622	ES5655	ES5687	ES5720
100	x 3.0	ES5405	ES5429	ES5451	ES5484	ES5517	ES5550	ES5583	ES5616	ES5649	ES5681	ES5714
150	x 3.0	ES5408	ES5432	ES5454	ES5487	ES5520	ES5553	ES5586	ES5619	ES5652	ES5684	ES5717
250	x 3.0	ES5412	ES5436	ES5458	ES5491	ES5524	ES5557	ES5590	ES5623	ES5656	ES5688	ES5721
100	x 4.6	ES5406	ES5430	ES5452	ES5485	ES5518	ES5551	ES5584	ES5617	ES5650	ES5682	ES5715
150	x 4.6	ES5409	ES5433	ES5455	ES5488	ES5521	ES5554	ES5587	ES5620	ES5653	ES5685	ES5718
250	x 4.6	ES5413	ES5437	ES5459	ES5492	ES5525	ES5558	ES5591	ES5624	ES5657	ES5689	ES5722
250	x 10.0	ES5414	ES5438	ES5460	ES5493	ES5526	ES5559	ES5592	ES5625	ES5658	ES5690	ES5723
150	x 20.0	ES5410	ES5434	ES5456	ES5489	ES5522	ES5555	ES5588	ES5621	ES5654	ES5686	ES5719
250	x 20.0	ES5415	ES5439	ES5461	ES5494	ES5527	ES5560	ES5593	ES5626	ES5659	ES5691	ES5724
250	x 30.0	ES5416	ES5440	ES5462	ES5495	ES5528	ES5561	ES5594	ES5627	ES5660	ES5692	ES5725

ChromegaChiral™ (10.0 µm)

Length (mm)	I.D. (mm)	CCA	CCC	CCJ	CCO	CCO F2	CCO F4	CCS	CC2	CC3	CC4
100	x 2.1	ES5417	ES5463	ES5496	ES5529	ES5562	ES5595	ES5628	ES5661	ES5693	ES5726
150	x 2.1	ES5420	ES5466	ES5499	ES5532	ES5565	ES5598	ES5631	ES5664	ES5696	ES5729
250	x 2.1	ES5423	ES5469	ES5502	ES5535	ES5568	ES5601	ES5634	ES5667	ES5699	ES5732
100	x 3.0	ES5418	ES5464	ES5497	ES5530	ES5563	ES5596	ES5629	ES5662	ES5694	ES5727
150	x 3.0	ES5421	ES5467	ES5500	ES5533	ES5566	ES5599	ES5632	ES5665	ES5697	ES5730
250	x 3.0	ES5424	ES5470	ES5503	ES5536	ES5569	ES5602	ES5635	ES5668	ES5700	ES5733
100	x 4.6	ES5419	ES5465	ES5498	ES5531	ES5564	ES5597	ES5630	ES5663	ES5695	ES5728
150	x 4.6	ES5422	ES5468	ES5501	ES5534	ES5567	ES5600	ES5633	ES5666	ES5698	ES5731
250	x 4.6	ES5425	ES5471	ES5504	ES5537	ES5570	ES5603	ES5636	ES5669	ES5701	ES5734
250	x 20.0	ES5426	ES5472	ES5505	ES5538	ES5571	ES5604	ES5637	ES5670	ES5702	ES5735
250	x 30.0	ES5427	ES5473	ES5506	ES5539	ES5572	ES5605	ES5638	ES5671	ES5703	ES5736

ChiraDex® HPLC Columns

ChiraDex® can be used for the separation of enantiomers of numerous different compounds. ChiraDex® is based on a beta-cyclodextrin covalently linked to spherical particles of silica and is well suited for chiral separations of hydrocarbons, steroids, phenyl esters, aromatic amines, heterocycles with 5-membered ring to 7-membered ring. Simply composed reversed phase-eluent can be used in most separations.

ChiraDex® (5.0 µm)

Length (mm)	I.D. (mm)	ChiraDex®	ChiraDex® HR
4	x 4	1.50117	on request
250	x 4	1.51333	on request
250	x 4	on request	1.51000

Biomacromolecule Characterization: A Multipronged Separation Challenge

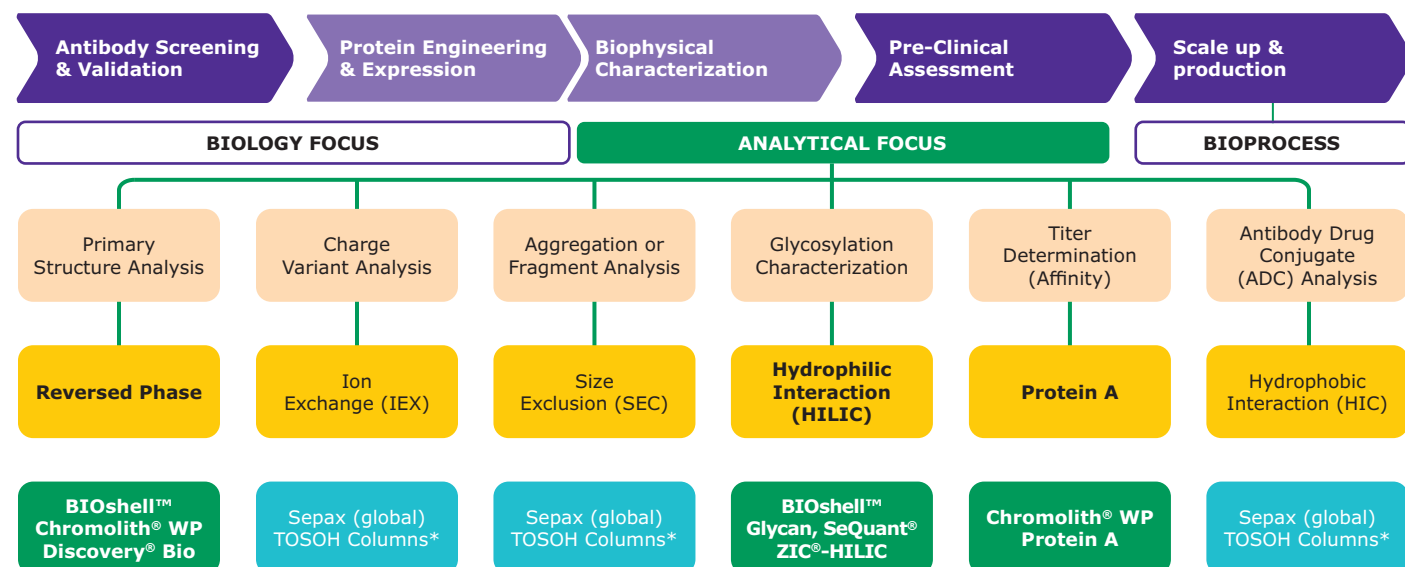

* Tosoh Bioscience columns are available in select countries. For a list, please go to the page 107 of this brochure.

Biomacromolecules (in particular monoclonal antibodies (mAbs)) have seen a renewed interest in the pharmaceutical and biotechnology industry. The reason for this high level of interest resides in the number of benefits these biological molecules have for patients including, but not limited to, high efficacy in treating an illness, high specificity for a target receptor or antigen, wide therapeutic range, and limited, undesirable side effects. However, due to the fact that these molecules are complex and are often produced in host cell lines, bacteria, or fermentation reactors, these potential therapeutics exhibit significant heterogeneity which needs to be evaluated and characterized using various analytical techniques. The complexity of such biomacromolecules can be easily illustrated by examining the structure of a typical mAb as depicted on the right.

mAbs are large, tetrameric immunoglobulin G (IgG) molecules with a molecular weight of approximately 150 kDa (150,000 g/mol). These molecules form a Y-shape composed of four peptide chains: two identical light (L) chains, with a molecular weight of approximately 25 kDa each, and two identical heavy (H) chains, with a molecular weight of approximately 50 kDa each. To form the Y-shape, these four polypeptide chains associate with each other through the creation of inter- and intra-chain disulfide bonds.

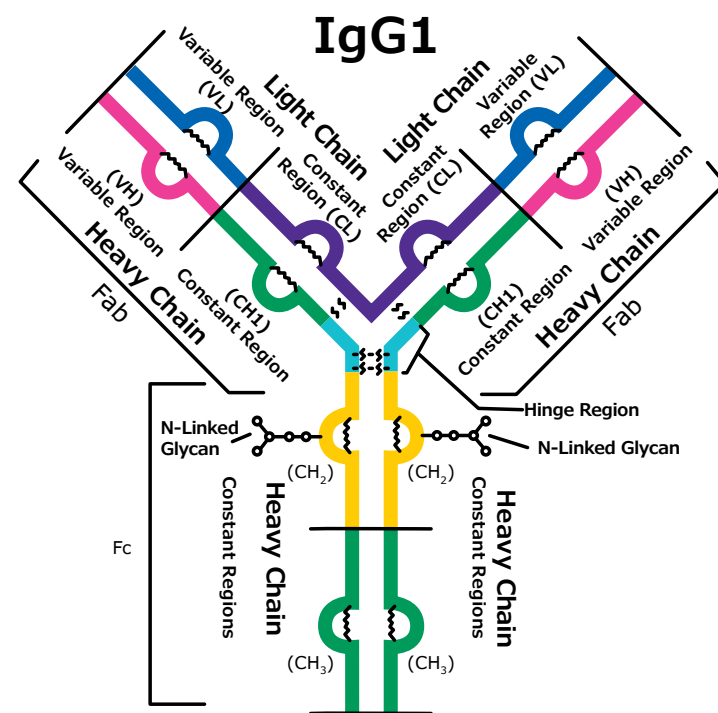

Due to the inherent complexity of biomacromolecules, multiple, orthogonal modes of chromatography to reversed-phase chromatography and HILIC are required to fully characterize these molecules.

Size Exclusion Chromatography

Size Exclusion Chromatography (SEC) is a mode of chromatography that separates molecules by their size (i.e. hydrodynamic radius). This mode of chromatography does not rely on the interaction of the analytes with a stationary phase ligand; it is an entropic process meaning that it relies on the random flow of the analytes through the stationary phase particles. For most practical purposes, this can be envisioned as analytes with a higher molecular weight will elute earlier in the run, since these analytes are fully or partially excluded from the pores of the stationary phase particles, while lower molecular weight analytes will elute later in the run, since these analytes will spend more time navigating the tortuous path through the particle.

Hydrophobic Interaction Chromatography

Hydrophobic Interaction Chromatography (HIC) is a mode of chromatography that separates analytes based on the degree of interaction between hydrophobic moieties on the analyte and hydrophobic ligands on the stationary phase. Under conditions of high concentrations of salt, the hydration layer around a protein may be disrupted enough such that it becomes entropically favorable for hydrophobic regions of the protein's surface to interface with the non-polar stationary phase. This phenomenon is not unlike the classical biochemical technique of protein salting out, but in HIC's case, the interactions are between protein-stationary phase ligand, not between different protein molecules. Due to the lower molecular weight and lower propensity for folding, HIC is usually not employed for separating peptides. Salt selection in HIC is dictated by the Hofmeister series, which classifies cations and anions in terms of their ability to disrupt the hydration layer around a protein (chaotropic) or promote the formation of a hydration layer (kosmotropic). Typical salts in HIC are ammonium sulfate, potassium sulfate, and sodium sulfate. Elution is achieved by gradients with decreasing salt concentration.

Ion Exchange Chromatography

Ion Exchange Chromatography (IEX) is a mode of chromatography that separates analytes by charge. Proteins and peptides are amphoteric, which means that they exhibit both acidic and basic functionalities. The acidic portions of a protein are provided by aspartic acid, glutamic acid, cysteine, tyrosine, and the α -carboxylate on the C-terminus. The basic portions of a protein are provided by arginine, histidine, lysine, and the α -amine on the N-terminus. Charge variants of a biotherapeutic, another critical quality attribute (CQA) that regulatory bodies require manufacturers to monitor, can be detected and resolved by IEX. These charge variants can arise from mistranslation of messenger RNA (mRNA) transcripts and/or post-translational modifications such as deamidation, oxidation, or glycosylation, among others.

Affinity Chromatography

Affinity chromatography is a mode of chromatography that relies on a specific interaction between the analyte of interest and the stationary phase ligand. Ideally, no other component of the sample would interact with the ligand, thus only the analyte of interest interacts with the stationary phase. Afterwards, a different mobile phase is passed through the column that breaks this interaction, thus eluting the analyte.

Reversed Phase Chromatography

Reversed-Phase Chromatography (RPC) is a mode of chromatography that separates analytes based primarily on hydrophobicity. Unlike HIC, RPC employs a water/organic mixture for the mobile phase. Typically, this mobile phase combination is supplemented with an ion pairing reagent like trifluoroacetic acid (TFA), formic acid, or difluoroacetic acid (DFA) to mask the secondary interactions between exposed silanols on the silica stationary phase and H-bonding donor groups on analytes. Common applications for characterizing biomolecules by RPC include peptide mapping, where a protease, like trypsin, cleaves a protein at defined sites into characteristic peptide fragments, and middle-up analyses, which include reducing a protein into larger fragments for easier characterization.

Sepax Technologies: HPLC Columns for Bioanalysis

Size Exclusion Chromatography (SEC)

Unix™ SEC-200 and SEC-300 UHPLC Columns

Utilizing proprietary surface technologies, Unix™ SEC-200 and SEC-300 phases are made of uniform, hydrophilic, and neutral nanometer thick films chemically bonded to high purity and mechanically stabilized silica with the particle size of 1.8 µm. The combination of small particle size and large pore volume of Unix™ SEC-300 renders the highest separation efficiency and resolution of analytes. The well-controlled surface chemistry results in excellent lot-to-lot reproducibility. The unique bonding chemistry, coupled with the maximized bonding density, allows Unix™ SEC-300 to provide high stability and negligible non-specific interactions. Typical applications for Unix™ SEC-300 columns include separation and analysis of biological molecules and water-soluble polymers.

Unix™ (1.8 µm)

Length (mm)	I.D. (mm)	SEC-200	SEC-300
150	x 4.6	Z777303	Z777300
300	x 4.6	Z777304	Z777302
Guard 10	x 4.0	Z777305	Z777301

SRT® and SRT®-C HPLC Columns

SRT® size exclusion columns are prepared from high purity, porous silica that is treated to provide the mechanical stability required for high performance HPLC analysis of biopolymers. The particles are derivatized with a uniform, hydrophilic bonded layer to minimize interaction of sample molecules with the silica surface. The proprietary surface technology results in excellent column-to-column reproducibility, while the composition of the bonded phase and the maximized bonding density impart excellent chemical stability and negligible non-specific interactions. In addition to the very high pore volume per unit column volume, SRT® columns are available in six different pore sizes from 100 Å to 2000 Å, allowing the user to select the pore size that best matches the dynamic radius of the biopolymer, be it a peptide, protein, virus, or vaccine. SRT®-C SEC columns are packed with high purity and mechanically stable, 5 µm, silica particles which are derivatized with a uniform, chemically neutral, hydrophilic bonded phase that effectively shields the sample from interacting with the underlying silica. Since SRT®-C columns can be operated up to 3500 psi pressure, they allow faster analysis and higher throughput than competitor columns. SRT®-C columns are the preferred choice for relatively hydrophobic sample types such as insulin, membrane proteins and derivatized monoclonal antibodies.

SRT® (5.0 µm)

Length (mm)	I.D. (mm)	Column Hardware	SEC-100	SEC-150	SEC-300	SEC-500	SEC-1000	SEC-2000
300	x 4.6	Stainless Steel	Z777037	Z777043	Z777049	Z777055	Z777061	Z777067
300	x 4.6	PEEK	Z777041	Z777047	Z777053	Z777059	Z777065	Z777071
300	x 7.8	Stainless Steel	Z777039	Z777045	Z777051	Z777057	Z777063	Z777069
Guard 50	x 4.6	Stainless Steel	Z777036	Z777042	Z777048	Z777054	Z777060	Z777066
Guard 50	x 4.6	PEEK	Z777040	Z777046	Z777052	Z777058	Z777064	Z777070
Guard 50	x 7.8	Stainless Steel	Z777038	Z777044	Z777050	Z777056	Z777062	Z777068

SRT®-C (5.0 µm)

Length (mm)	I.D. (mm)	Column Hardware	SEC-100	SEC-150	SEC-300	SEC-500	SEC-1000	SEC-2000
300	x 4.6	Stainless Steel	Z777096	Z777102	Z777108	Z777114	Z777120	Z777126
300	x 4.6	PEEK	Z777100	Z777106	Z777112	Z777118	Z777124	Z777130
300	x 7.8	Stainless Steel	Z777098	Z777104	Z777110	Z777116	Z777122	Z777128
Guard 50	x 4.6	Stainless Steel	Z777095	Z777101	Z777107	Z777113	Z777119	Z777125
Guard 50	x 4.6	PEEK	Z777099	Z777105	Z777111	Z777117	Z777123	Z777129
Guard 50	x 7.8	Stainless Steel	Z777097	Z777103	Z777109	Z777115	Z777121	Z777127

Zenix™ and Zenix™-C HPLC Columns

Use Zenix™ SEC high performance gel filtration columns to analyze hydrophilic polymers including proteins and other water soluble polymers. Prepared from spherical 3 µm silica particles, Zenix™ SEC columns represent a breakthrough technology for high performance size exclusion chromatography of biopolymers. The combination of 3 µm silica particle size and a proprietary surface technology provides the highest separation efficiency and resolution for biological molecules and water soluble polymers. Zenix™ columns are available in 100, 150 and 300 Å pore sizes, and are packed in stainless steel or PEEK hardware. Since Zenix™ columns can be operated up to 3500 psi pressure, they allow fast analysis and high

sample throughput. Zenix™-C SEC columns are the preferred gel filtration columns to analyze relatively hydrophobic sample types such as insulin, membrane proteins and derivatized monoclonal antibodies. Zenix™-C SEC columns are packed with high purity and mechanically stable, 3 µm, silica particles that are chemically modified with a uniform, chemically neutral, hydrophilic bonded phase that effectively shields the sample from interacting with the underlying silica. Since Zenix™-C columns can be operated up to 3500 psi pressure, they allow fast analysis and high sample throughput. Zenix™-C columns are available in 100, 150 and 300 Å pore sizes, and are packed in stainless steel or PEEK hardware.

Zenix™ (3.0 µm)

Length (mm)	I.D. (mm)	Column Hardware	SEC-100	SEC-150	SEC-300
300	x 1.0	Stainless Steel	Z777002	Z777012	Z777022
300	x 2.1	Stainless Steel	Z777004	Z777014	Z777024
150	x 4.6	Stainless Steel			Z777026
250	x 4.6	Stainless Steel			Z777027
300	x 4.6	Stainless Steel	Z777006	Z777016	Z777028
300	x 4.6	PEEK	Z777010	Z777020	Z777035
150	x 7.8	Stainless Steel			Z777030
200	x 7.8	Stainless Steel			Z777031
250	x 7.8	Stainless Steel			Z777032
300	x 7.8	Stainless Steel	Z777008	Z777018	Z777033
Guard 50	x 1.0	Stainless Steel	Z777001	Z777011	Z777021
Guard 50	x 2.1	Stainless Steel	Z777003	Z777013	Z777023
Guard 50	x 4.6	Stainless Steel	Z777005	Z777015	Z777025
Guard 50	x 4.6	PEEK	Z777009	Z777019	Z777034
Guard 50	x 7.8	Stainless Steel	Z777007	Z777017	Z777029

Zenix™-C (3.0 µm)

Length (mm)	I.D. (mm)	Column Hardware	SEC-100	SEC-150	SEC-300
150	x 4.6	Stainless Steel			Z777085
250	x 4.6	Stainless Steel			Z777086
300	x 4.6	Stainless Steel	Z777073	Z777079	Z777087
300	x 4.6	PEEK	Z777077	Z777083	Z777094
150	x 7.8	Stainless Steel			Z777089
200	x 7.8	Stainless Steel			Z777090
250	x 7.8	Stainless Steel			Z777091
300	x 7.8	Stainless Steel	Z777075	Z777081	Z777092
Guard 50	x 4.6	Stainless Steel	Z777072	Z777078	Z777084
Guard 50	x 4.6	PEEK	Z777076	Z777082	Z777093
Guard 50	x 7.8	Stainless Steel	Z777074	Z777080	Z777088

Ion Exchange Chromatography

Antibodix™ U/HPLC Columns

Antibodix™ columns are specially designed for high resolution, high efficiency and high recovery separations of antibodies. These columns are packed with spherical, non-porous, particles that consist of highly cross-linked poly(styrene divinylbenzene) (PS/DVB). Antibodix™ columns are available packed

with 1.7, 3, 5 or 10 µm particles that can withstand pressures varying from 4,000 psi (10 µm) up to 10,000 psi (1.7 µm). The hydrophobic PS/DVB resin surface is shielded by a hydrophilic, neutral polymer to which a dense layer of weak cation-exchange functional groups are attached, thus combining the benefits of minimal secondary interaction of antibodies with the base matrix and high dynamic binding capacity.

A. Antibodix™ WCX-NP10

25 cm x 4.6 mm I.D., 10 µm (non-porous)

B. Vendor D WCX

25 cm x 4.0 mm I.D., 10 µm (non-porous)

1. Cytochrome c (12.2 kDa)
2. Lysozyme (14.3 kDa)
3. Ribonuclease A (13.7 kDa)

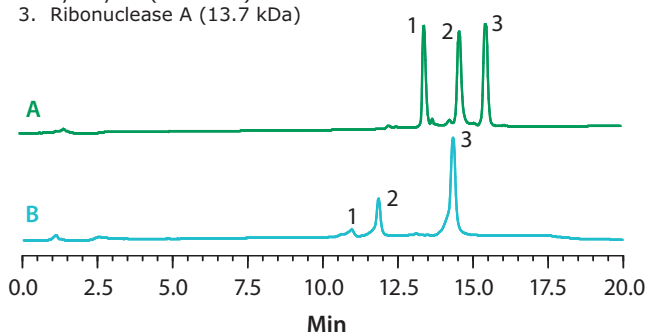

Column:	Antibodix™ WCX-NP10, 25 cm x 4.6 mm I.D., 10 µm (Z777272)
Column temp.:	25 °C
Mobile phase:	(A) 10 mM sodium phosphate buffer, 6.0; (B) A + 1.0 M sodium chloride
Gradient:	0 to 100% B in 42 min
Flow rate:	1.0 mL/min
Sample:	1 mg/mL each
Injection:	5 µL
Detector:	UV, 214 nm

Antibodix™ (1.7 µm)

Length (mm)	I.D. (mm)	Column Hardware	SKU
30	x 2.1	Stainless Steel	Z777278
50	x 4.6	Stainless Steel	Z777280
Guard 10	x 2.0	Stainless Steel	Z777277
Guard 10	x 4.0	Stainless Steel	Z777279

Antibodix™ (5.0 µm)

Length (mm)	I.D. (mm)	Column Hardware	SKU
50	x 2.1	Stainless Steel	Z777290
50	x 2.1	PEEK	Z777295
50	x 4.6	Stainless Steel	Z777292
50	x 4.6	PEEK	Z777296
150	x 4.6	Stainless Steel	Z777293
250	x 4.6	Stainless Steel	Z777294
250	x 4.6	PEEK	Z777297
Guard 10	x 2.0	Stainless Steel	Z777289
Guard 10	x 4.0	Stainless Steel	Z777291

Antibodix™ (3.0 µm)

Length (mm)	I.D. (mm)	Column Hardware	SKU
30	x 2.1	Stainless Steel	Z777282
50	x 2.1	Stainless Steel	Z777283
50	x 2.1	PEEK	Z777287
50	x 4.6	Stainless Steel	Z777285
50	x 4.6	PEEK	Z777288
150	x 4.6	Stainless Steel	Z777286
Guard 10	x 2.0	Stainless Steel	Z777281
Guard 10	x 4.0	Stainless Steel	Z777284

Antibodix™ (10.0 µm)

Length (mm)	I.D. (mm)	Column Hardware	SKU
50	x 2.1	Stainless Steel	Z777268
50	x 2.1	PEEK	Z777273
250	x 2.1	Stainless Steel	Z777269
250	x 2.1	PEEK	Z777274
50	x 4.6	Stainless Steel	Z777271
50	x 4.6	PEEK	Z777275
250	x 4.6	Stainless Steel	Z777272
250	x 4.6	PEEK	Z777276
Guard 10	x 2.0	Stainless Steel	Z777267
Guard 10	x 4.0	Stainless Steel	Z777270

Proteomix® U/HPLC Columns

Based on Non-Porous Particles, the Proteomix® ion-exchange column line from Sepax Technologies was designed to achieve high recovery of peptides, proteins, oligonucleotides, polysaccharides, cell lysates, nanoparticles and nanotubes when analyzed under HPLC or UHPLC conditions. Proteomix® columns are packed with spherical, non-porous, poly(styrene divinylbenzene) (PS/DVB) particles that are encapsulated with a hydrophilic, neutral polymer layer

to eliminate non-specific binding. Using proprietary coupling chemistry, weak (WAX and WCX) and strong (SAX and SCX) anion and cation exchange functional groups are attached to the hydrophilic bonded phase to obtain a high capacity ion-exchange layer. Proteomix® columns are available packed with 1.7, 3, 5 or 10 µm particles that can withstand pressures varying from 4,000 psi (10 µm) up to 10,000 psi (1.7 µm). Non-porous Proteomix® ion-exchange columns are unique as they combine increased ion exchange capacity with high efficiency, recovery and throughput.

Proteomix® Anion Exchange (1.7 µm)

Length (mm)	I.D. (mm)	Column Hardware	Quaternary Ammonium	Tertiary Amine
30	x 2.1	Stainless Steel	Z777210	Z777244
30	x 4.6	Stainless Steel	Z777213	Z777247
50	x 2.1	Stainless Steel	Z777211	Z777245
50	x 4.6	Stainless Steel	Z777214	Z777248
Guard 10	x 2.0	Stainless Steel	Z777209	Z777243
Guard 10	x 4.0	Stainless Steel	Z777212	Z777246

Proteomix® Anion Exchange (5.0 µm)

Length (mm)	I.D. (mm)	Column Hardware	Quaternary Ammonium	Tertiary Amine
50	x 2.1	Stainless Steel	Z777224	Z777258
50	x 2.1	PEEK	Z777230	Z777264
150	x 2.1	Stainless Steel	Z777225	Z777259
50	x 4.6	Stainless Steel	Z777227	Z777261
50	x 4.6	PEEK	Z777231	Z777265
150	x 4.6	Stainless Steel	Z777228	Z777262
250	x 4.6	Stainless Steel	Z777229	Z777263
250	x 4.6	PEEK	Z777232	Z777266
Guard 10	x 2.0	Stainless Steel	Z777223	Z777257
Guard 10	x 4.0	Stainless Steel	Z777226	Z777260

Proteomix® Anion Exchange (3.0 µm)

Length (mm)	I.D. (mm)	Column Hardware	Quaternary Ammonium	Tertiary Amine
30	x 2.1	Stainless Steel	Z777216	Z777250
50	x 2.1	Stainless Steel	Z777217	Z777251
50	x 2.1	PEEK	Z777221	Z777255
50	x 4.6	Stainless Steel	Z777219	Z777253
50	x 4.6	PEEK	Z777222	Z777256
150	x 4.6	Stainless Steel	Z777220	Z777254
Guard 10	x 2.0	Stainless Steel	Z777215	Z777249
Guard 10	x 4.0	Stainless Steel	Z777218	Z777252

Proteomix® Anion Exchange (10.0 µm)

Length (mm)	I.D. (mm)	Column Hardware	Quaternary Ammonium	Tertiary Amine
50	x 2.1	Stainless Steel	Z777200	Z777234
50	x 2.1	PEEK	Z777205	Z777239
250	x 2.1	Stainless Steel	Z777201	Z777235
250	x 2.1	PEEK	Z777206	Z777240
50	x 4.6	Stainless Steel	Z777203	Z777237
50	x 4.6	PEEK	Z777207	Z777241
250	x 4.6	Stainless Steel	Z777204	Z777238
250	x 4.6	PEEK	Z777208	Z777242
Guard 10	x 2.0	Stainless Steel	Z777199	Z777233
Guard 10	x 4.0	Stainless Steel	Z777202	Z777236

Proteomix® Cation Exchange (1.7 µm)

Length (mm)	I.D. (mm)	Column Hardware	Sulfonate	Carboxylate
30	x 2.1	Stainless Steel	Z777142	Z777176
30	x 4.6	Stainless Steel	Z777145	Z777179
50	x 2.1	Stainless Steel	Z777143	Z777177
50	x 4.6	Stainless Steel	Z777146	Z777180
Guard 10	x 2.0	Stainless Steel	Z777141	Z777175
Guard 10	x 4.0	Stainless Steel	Z777144	Z777178

Proteomix® Cation Exchange (5.0 µm)

Length (mm)	I.D. (mm)	Column Hardware	Sulfonate	Carboxylate
50	x 2.1	Stainless Steel	Z777156	Z777190
50	x 2.1	PEEK	Z777162	Z777196
150	x 2.1	Stainless Steel	Z777157	Z777191
50	x 4.6	Stainless Steel	Z777159	Z777193
50	x 4.6	PEEK	Z777163	Z777197
150	x 4.6	Stainless Steel	Z777160	Z777194
250	x 4.6	Stainless Steel	Z777161	Z777195
250	x 4.6	PEEK	Z777164	Z777198
Guard 10	x 2.0	Stainless Steel	Z777155	Z777189
Guard 10	x 4.0	Stainless Steel	Z777158	Z777192

Proteomix® Cation Exchange (3.0 µm)

Length (mm)	I.D. (mm)	Column Hardware	Sulfonate	Carboxylate
30	x 2.1	Stainless Steel	Z777148	Z777182
50	x 2.1	Stainless Steel	Z777149	Z777183
50	x 2.1	PEEK	Z777153	Z777187
50	x 4.6	Stainless Steel	Z777151	Z777185
50	x 4.6	PEEK	Z777154	Z777188
150	x 4.6	Stainless Steel	Z777152	Z777186
Guard 10	x 2.0	Stainless Steel	Z777147	Z777181
Guard 10	x 4.0	Stainless Steel	Z777150	Z777184

Proteomix® Cation Exchange (10.0 µm)

Length (mm)	I.D. (mm)	Column Hardware	Sulfonate	Carboxylate
50	x 2.1	Stainless Steel	Z777132	Z777166
50	x 2.1	PEEK		Z777171
250	x 2.1	Stainless Steel	Z777133	Z777167
250	x 2.1	PEEK	Z777138	Z777172
50	x 4.6	Stainless Steel	Z777135	Z777169
50	x 4.6	PEEK	Z777139	Z777173
250	x 4.6	Stainless Steel	Z777136	Z777170
250	x 4.6	PEEK	Z777140	Z777174
Guard 10	x 2.0	Stainless Steel	Z777131	Z777165
Guard 10	x 4.0	Stainless Steel	Z777134	Z777168

Proteomix® HIC (5.0 µm)

Length (mm)	I.D. (mm)	Butyl	Ethyl	Phenyl	Propyl
50	x 2.1	61862-U			
35	x 4.6		61869-U	61874-U	61881-U
100	x 4.6	61865-U	61870-U	61876-U	61883-U

Length (mm)	I.D. (mm)	Butyl	Ethyl	Phenyl	Propyl
150	x 4.6	61866-U			
50	x 7.8	61867-U	61871-U	61878-U	61884-U
Guard 10	x 4.0	61863-U	61868-U	61873-U	61879-U

Tosoh* Bioscience: HPLC Columns for Bioanalysis

Size Exclusion Chromatography (SEC)

TSKgel® UP-SW2000 and UP-SW3000 UHPLC Columns

TSKgel® UP-SW3000 and UP-SW2000, the new 2 µm UHPLC columns with 25 nm and 12.5 nm pore sizes, respectively, are the latest addition to the renowned TSKgel® SW series. TSKgel® UP-SW represents the fifth generation of high performance gel filtration columns. These columns feature the same pore size as the well-established TSKgel® G3000SWXL and SuperSW2000 columns and facilitate method transfer from conventional gel filtration to UHPLC technology. The 15 cm column is used to shorten analysis time while maintaining resolution. The 30 cm column delivers dramatically increased resolution between fragments, monomers, and aggregates.

TSKgel® UP-SW (2.0 µm)

Length (mm)	I.D. (mm)	SW3000	SW2000
150	x 4.6	80023449	823515
300	x 4.6	80023448	823514
Direct Connect Guard 20	x 4.6	80023451	823517
Guard 20	x 4.6	80023450	823516

TSKgel® SW_{XL} (5.0 µm)

Length (mm)	I.D. (mm)	G2000	G3000	G4000	QC-PAK 200	QC-PAK 300	SW _{XL} -125	SW _{XL} -250	SW _{XL} -450
150	x 7.8				816215	816049			
300	x 7.8	808540	808541				820027	820026	

TSKgel® SW_{XL} (7.0 µm)

Length (mm)	I.D. (mm)	G2000	G3000	G4000	QC-PAK 200	QC-PAK 300	SW _{XL} -125	SW _{XL} -250	SW _{XL} -450
Guard 40	x 6.0						818008	808543	

TSKgel® SW_{XL} (8.0 µm)

Length (mm)	I.D. (mm)	G2000	G3000	G4000	QC-PAK 200	QC-PAK 300	SW _{XL} -125	SW _{XL} -250	SW _{XL} -450
300	x 7.8			808542					820025

*Tosoh Bioscience columns are available in the following countries: Argentina, Albania, Andorra, Armenia, Austria, Azerbaijan, Afghanistan, Algeria, Albania, Armenia, Azerbaijan, Bolivia, Brazil, Belarus, Belgium, Bosnia and Herzegovina, Bulgaria, Bahrain, Bosnia-Herzegovina, Botswana, Burkina-Faso, Chile, Colombia, Costa Rica, Cuba, Caribbean Islands, Canada, Croatia, Cyprus, Czechia, Cameroon, Central Afr. Rep, Chad, Congo, Congo dem. Rep., Croatia, Denmark, Dominican Republic, Djibouti, Ecuador, El Salvador, Egypt, Eritrea, Ethiopia, Estonia, French Guiana, Finland, France, Georgia, Germany, Greece, Gabon, Georgia, Ghana, Guatemala, Guyana, Haiti, Honduras, Hungary, Iceland, Ireland, Italy, Iraq, Israel, Kazakhstan, Kosovo, Kenya, Kosovo, Kuwait, Kyrgyzstan, Lebanon, Libya, Latvia, Liechtenstein, Lithuania, Luxembourg, Malta, Moldova, Monaco, Montenegro, Macedonia, Madagascar, Malawi, Mauritania, Mauritius, Moldavia, Mongolia, Morocco, Mozambique, Mexico, Nicaragua, Nigeria, Netherlands, North Macedonia (formerly Macedonia), Norway, Oman, Poland, Portugal, Panama, Paraguay, Peru, Puerto Rico, Qatar, Rwanda, Romania, Russia, San Marino, Serbia, Slovakia, Slovenia, Spain, Sweden, Suriname Switzerland, Saudi Arabia, Senegal, Serbia-Montenegro, South Africa, Tadjikistan, Tanzania, Togo, Tunisia, Turkey, Turkmenistan, Ukraine, United Kingdom (UK), Uruguay, United States of America, Uganda, Utd.Arab.Emir., Uzbekistan, Vatican City, Venezuela, Yemen, Zambia, Zimbabwe, Belize

Hydrophobic Interaction Chromatography (HIC)

Proteomix® HIC U/HPLC Columns

Proteomix® HIC columns are specially designed for high resolution and high efficiency separations of proteins and oligonucleotides. Utilizing proprietary surface technologies, Proteomix® HIC-NP resin is made of non-porous polystyrenedivinylbenzene (PS/DVB) beads with narrow-dispersed particle size distribution. The PS/DVB bead is modified with alkyl groups or aryl group that provides hydrophobic interaction with analytes. Proteomix® HIC-NP resin is highly rigid and mechanically stable. In comparison to silica-based HIC phase media, Proteomix® HIC-NP phases have advantages for biomolecule separations with wide pH range (2-12) and high thermal stability. The nonporous structure and narrow particle size distribution offer special selectivity, high resolution separation of proteins such as mAb (monoclonal antibody), ADC (antibody drug conjugate) and related protein fragments, DNA and oligonucleotides. Proteomix® HIC-NP media is applicable at laboratory discovery, laboratory-scale purification and process chromatography for the production of a few mgs to kilogram of proteins.

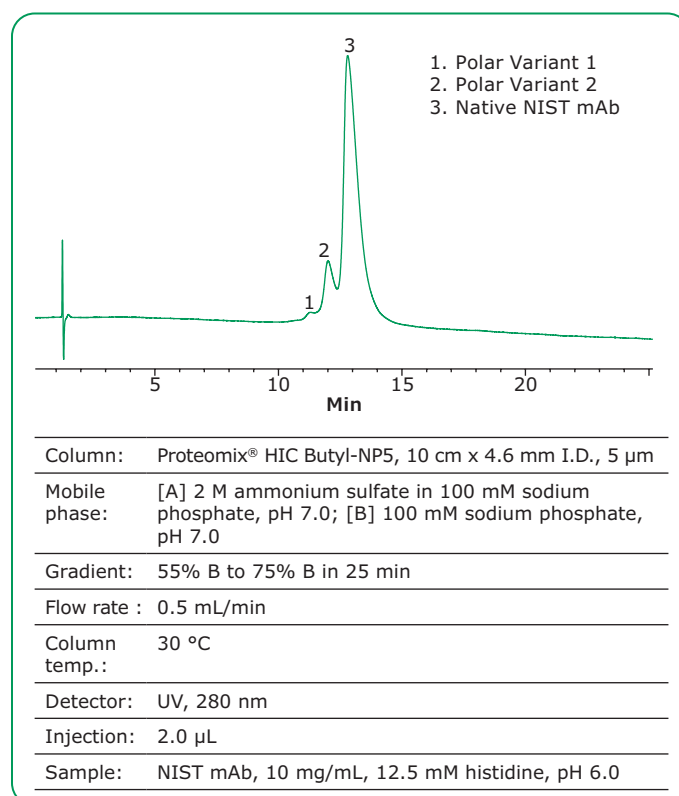

TSKgel® SuperSW, SuperSW mAb and UltraSW Aggregate HPLC Columns

TSKgel® SuperSW columns, introduced in 1997, represent the third generation of high performance Gel Filtration columns that have become synonymous with analyzing protein molecular weights in the emerging field of biotechnology. TSKgel® SuperSW-type columns contain smaller particles than TSKgel® SWxl-type columns: 4 µm versus 5 µm. In addition, the column internal diameter has been reduced from 7.8 mm I.D. to 4.6 mm I.D. to provide higher sensitivity in sample-limited cases and to cut down on solvent use; in addition to 4.6 mm I.D., TSKgel® SuperSW3000 columns are also available in 2 mm and 1 mm I.D. column formats. It is important to employ an HPLC system that is optimized with regards to extra-column band broadening to take full advantage of the high column efficiency that can be obtained on TSKgel® SuperSW columns. The TSKgel® SW mAb product line consist of three specialized columns designed for the separation and analysis of monoclonal antibodies (mAb). While mAbs can be analyzed using many different modes of HPLC, size exclusion is best to determine aggregation, dimer, and fragmentation, making it the best method for heterogeneity studies. The TSKgel® SW mAb columns include:

- TSKgel® SuperSW mAb HR column is best suited for high resolution analysis of mAb monomer and dimer
- TSKgel® SuperSW mAb HTP column is optimized for high throughput analysis of mAb monomer and dimer (UHPLC compatible)

TSKgel® UltraSW Aggregate column provides the best solution for the analysis of mAb aggregates. Compared to competitive columns, these stainless steel, silica-based TSKgel® columns offer reduced lot-to-lot variation, long column life, reduction of unspecified adsorption, and superior recovery of aggregates. The TSKgel® SW mAb columns utilize a unique pore-controlled technology, which produces a shallow calibration curve in the molecular weight region of a typical monoclonal antibody. The calibration curve for the TSKgel® SuperSW mAb HR column is similar to that of the TSKgel® G3000SWxl column and has a shallower slope than the TSKgel® UltraSW Aggregate column around the molecular weight range of gamma-globulin. This shallow calibration curve produces high resolution separations. The TSKgel® UltraSW Aggregate calibration curve shows a separation range up to around 2 million Da, which implies better resolution of aggregate/multimer of a monoclonal antibody.

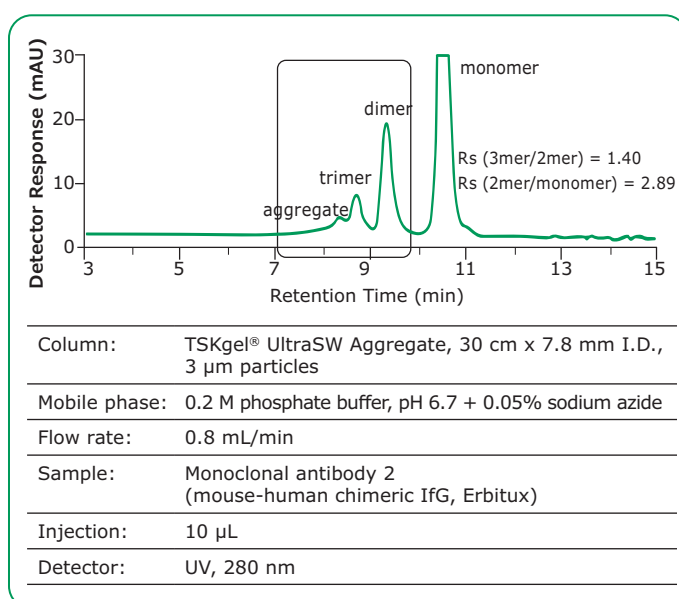

TSKgel® SuperSW (4.0 µm) and UltraSW (3.0 µm)

Length (mm)	I.D. (mm)	mAb-HR	mAb-HTP	2000	3000	UltraSW-Aggregate
300	x 1.0				821845	
300	x 2.0				821485	
150	x 4.6		822855			
300	x 4.6			818674	818675	
300	x 7.8	822854				822856
Guard 30	x 3.0		822858			
Guard 35	x 4.6			818762		
Guard 40	x 6.0	822857				822859

TSKgel® SW Type HPLC Columns

TSKgel® SW columns, introduced in 1977, were the first of a long line of high performance Gel Filtration columns that have become synonymous with analyzing protein molecular weights in the emerging field of biotechnology. TSKgel® SW-type columns are based on highly porous silica particles with a surface functionalized with diol groups to prevent any interaction with proteins. TSKgel® SW-type columns distinguish themselves from other silica- or polymer-based high performance size exclusion columns by virtue of their large pore volumes.

TSKgel® SW (10.0 µm)

Length (mm)	I.D. (mm)	G2000	G3000
300	x 7.5	805788	805789
600	x 7.5	805102	805103
300	x 8.0		808800
Guard 75	x 7.5	805371	
Guard 40	x 8.0	808805	

TSKgel® SW (13.0 µm)

Length (mm)	I.D. (mm)	G2000	G3000	G4000
300	x 7.5			805790
600	x 7.5			805104
300	x 8.0			808801
300	x 21.5	806727	806728	
600	x 21.5	805146	805147	
Guard 75	x 21.5	805758		

TSKgel® SW (17.0 µm)

Length (mm)	I.D. (mm)	G4000
300	x 21.5	806729
600	x 21.5	805148

Ion Exchange Chromatography

Ion exchange chromatography separates molecules based on differences in the net charge of the molecules. In anion exchange, the analyte is negatively charged (anion), while the chromatographic material is positively charged (cation). Ion exchange is commonly used for protein purification, but it may be used for purification of oligonucleotides, peptides, or other charged molecules. For interaction to occur, the protein of interest must have a charge opposite to that of the functional group of the sorbent particle. Because the interaction is ionic, binding must take place under low ionic strength conditions. Elution is achieved by increasing the ionic strength of the mobile phase to reduce ionic attractions, or by changing the pH of the mobile phase to alter the ionization state of the protein.

TSKgel® columns are highly efficient for sample purification with excellent recovery. Anion- and cation-exchangers are available on porous polymer-based and silica-based particles. Proteins and nucleic acids can be analyzed faster on a TSKgel® non-porous resin column, although STAT and NPR columns have lower capacity than particles with large pore sizes. TSKgel® BioAssist columns are constructed from PEEK (polyether ether ketone).

Anion Exchange HPLC Columns:

TSKgel® 5PW Anion Exchange (10.0 µm)

Length (mm)	I.D. (mm)	DEAE	SuperQ
75	x 2.0	818757	
50	x 5.0	813061	
75	x 7.5	807164	818257
75	x 8.0	808802	818386

TSKgel® 5PW Anion Exchange (13.0 µm)

Length (mm)	I.D. (mm)	DEAE	SuperQ
150	x 20	814016	
150	x 21.5	807574	818387
Guard 20	x 20	814466	

TSKgel® 5PW Anion Exchange (20.0 µm)

Length (mm)	I.D. (mm)	DEAE	SuperQ
Guard 25	x 6.0	807210	818388
Guard 10	x 8.0	808806	
Guard 35	x 10.0	816092	

TSKgel® NPR

Length (mm)	I.D. (mm)	2.5 µm	5.0 µm
35	x 4.6	813075	
75	x 4.6	818249	
Guard 5	x 4.6	818253	817088

TSKgel® BioAssist Q

Length (mm)	I.D. (mm)	10 µm	13 µm
50 mm	x 4.6 mm	819685	
100 mm	x 10 mm		821410

TSKgel® STAT

Length (mm)	I.D. (mm)	5.0 µm	7.0 µm	10.0 µm
35	x 3.0			821960
100	x 4.6	821962	821961	

Silica-based TSKgel® DEAE Anion Exchange

Length (mm)	I.D. (mm)	5.0 µm	10.0 µm	20.0 µm
250	x 2.0	818761		
250	x 4.6	807168		
75	x 7.5		807163	
Guard 10	x 2.0	842154		
Guard 25	x 6.0			807648

Silica-based TSKgel® QAE Anion Exchange

Length (mm)	I.D. (mm)	SKU
250	x 4.6	807166
Guard 25	x 6.0	807646

Cation Exchange HPLC Columns:

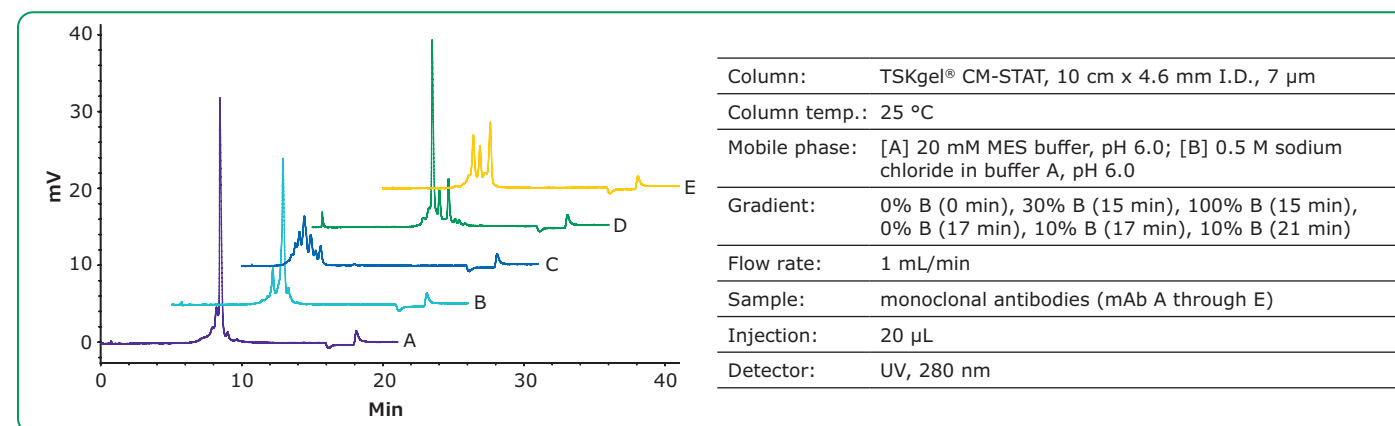

TSKgel® 5PW Cation Exchange (10.0 µm)

Length (mm)	I.D. (mm)	CM	SP
75	x 2.0		818758
50	x 5.0		813062
75	x 7.5	813068	807161
75	x 8.0		808803
Guard 25	x 6.0	813069	

TSKgel® 5PW Cation Exchange (13.0 µm)

Length (mm)	I.D. (mm)	SP
150	x 20	814017
150	x 21.5	807575

TSKgel® 5PW Cation Exchange (20.0 µm)

Length (mm)	I.D. (mm)	SP
Guard 25	x 6.0	807211
Guard 10	x 8.0	808807
Guard 35	x 10.0	816093

TSKgel® BioAssist S

Length (mm)	I.D. (mm)	7.0 µm	13.0 µm
50	x 4.6	819686	
100	x 10		821411

TSKgel® NPR Cation Exchange (2.5 µm)

Length (mm)	I.D. (mm)	SKU
35	x 4.6	813076

TSKgel® STAT Carboxymethyl

Length (mm)	I.D. (mm)	7.0 µm	10.0 µm
35	x 3.0		821965
100	x 4.6	821966	

TSKgel® STAT Sulfonic Acid

Length (mm)	I.D. (mm)	7.0 µm	10.0 µm
35	x 3.0		821963
100	x 4.6	821964	

Silica-based TSKgel® Carboxymethyl Cation Exchange

Length (mm)	I.D. (mm)	5.0 µm	10.0 µm
250	x 4.6	807167	
75	x 7.5		807162
Guard 25	x 6.0		807650

Silica-based TSKgel® Sulfonic Acid Cation Exchange

Length (mm)	I.D. (mm)	5.0 µm
250	x 4.6	807165
Guard 25	x 6.0	807644

Hydrophobic Interaction Chromatography (HIC)

Hydrophobic Interaction Chromatography (HIC) is a gentle technique compared to reversed-phase LC for the binding and desorption of hydrophobic proteins. The use of aqueous mobile phases in HIC is less likely to disturb protein conformation and results in better activity recovery. Biomolecules adsorb to a weak hydrophobic surface at high salt concentrations

and are eluted by a decreasing salt gradient. As a result, hydrophobic interaction chromatography combines the gentleness of salt precipitation with the precision of chromatography for excellent recovery of protein activity.

TSKgel® BioAssist Phenyl columns are constructed from PEEK (polyether ether ketone).

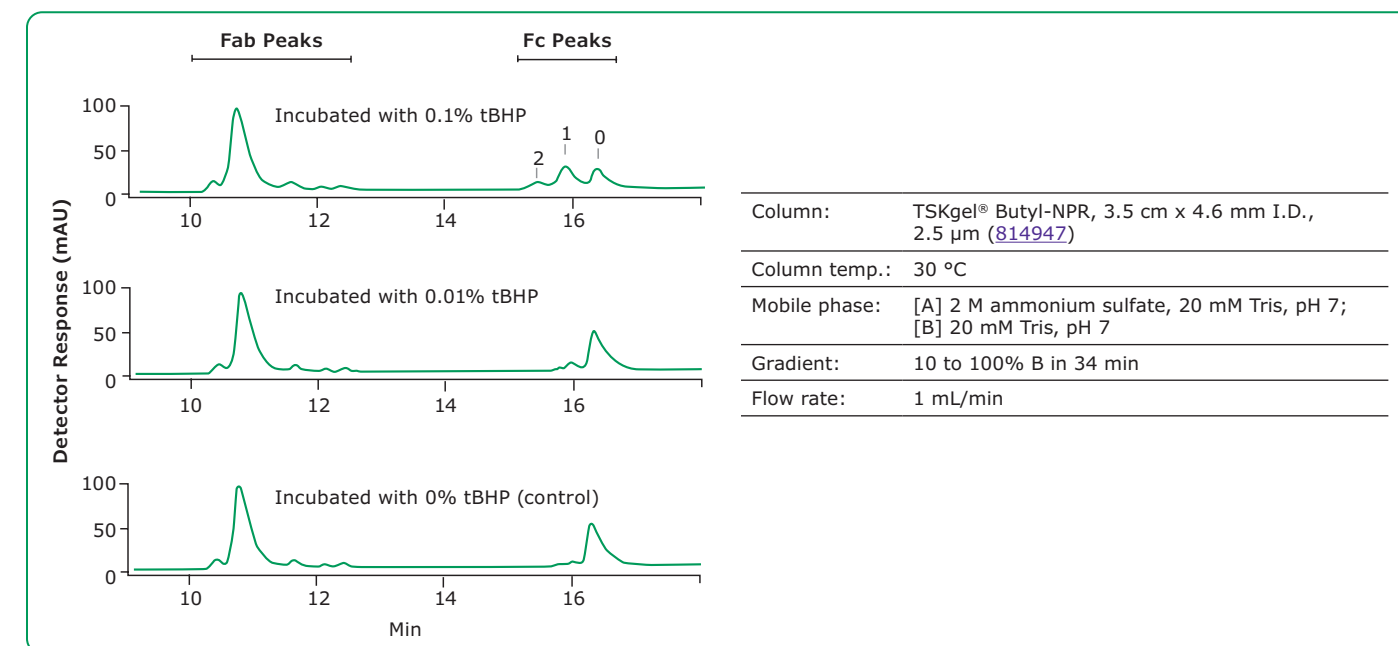

TSKgel® Butyl NPR

Length (mm)	I.D. (mm)	SKU
35	x 4.6	814947
100	x 4.6	842168

TSKgel® Phenyl-5PW

Length (mm)	I.D. (mm)	10 µm	13 µm	20 µm
75	x 2.0	818759		
50	x 5.0	813063		
75	x 7.5	807573		
50	x 7.8	820023		
75	x 8.0	808804		
150	x 21.5		807656	
Guard 25	x 6.0			807652
Guard 35	x 10.0			816095

TSKgel® Ether-5PW

Length (mm)	I.D. (mm)	10.0 µm	20.0 µm
10	x 2.0	842156	
75	x 2.0	818760	
50	x 5.0	814013	
75	x 7.5	808641	
10	x 8.0		814025
75	x 8.0	814014	
Guard 25	x 6.0		808643

Affinity Chromatography

Affinity chromatography allows purification of biomolecules on the basis of biological function or three-dimensional structure. The molecule to be purified is specifically and reversibly adsorbed by a complementary binding ligand immobilized on a matrix. The natural specificities of the interacting molecules offer high selectivities that can greatly reduce the time needed to purify the molecule. High-efficiency resin-based TSKgel® affinity columns separate or purify many enzymes and other proteins.

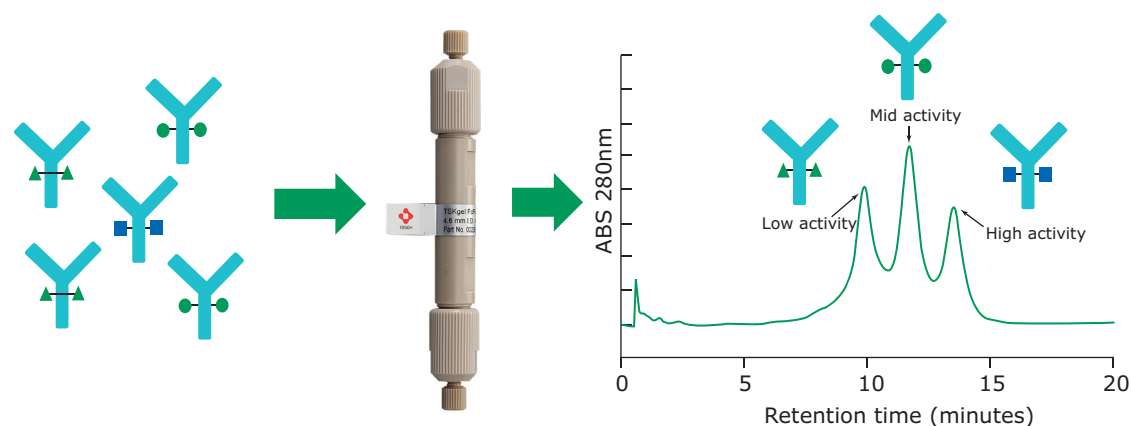

Chromatographic Conditions

Column:	TSKgel® FcR-IIIa-NPR, 7.5 cm x 4.6 mm I.D., 5 µm, PEEK (823513)
Mobile phase:	[A] 50 mM Citrate, pH 6.5 ; [B] 50 mM Citrate, pH 4.5
Flow rate:	1 mL/min
Column temp.:	25 °C
Detector:	UV, 260 nm
Injection:	30 µL
Sample:	Rituximab, 1 µg/µL, Rituximab kindly provided by Rentschler Biopharma

TSKgel® Iminodiacetic Acid

Length (mm)	I.D. (mm)	10 µm	13 µm	20 µm
50	x 5.0	814440		
75	x 7.5	808645		
50	x 7.8	820022		
150	x 21.5		808646	
Guard 25	x 6.0			808647

TSKgel® Boronate

Length (mm)	I.D. (mm)	10 µm	20 µm
50	x 5.0	814449	
75	x 7.5	813066	
Guard 25	x 6.0		813125
Guard 10	x 8.0		814451

Chromolith® Protein A monolithic columns for Affinity Chromatography, please see page 55

TSKgel® Tresyl (10 µm)

Length (mm)	I.D. (mm)	SKU
40	x 6.0	814455
75	x 7.5	814456

TSKgel® FcR (5.0 µm)

Length (mm)	I.D. (mm)	SKU
75	x 4.6	823513

Protein Purification Chromatography

You have a diverse set of molecules that need to be purified. We have a full suite of industry-trusted and proven chromatography resins and membranes to help you to tackle them all from lab to process scale.

- Membrane Chromatography
- Affinity Chromatography
- Ion Exchange Chromatography
- Prepacked Columns
- Process Chemicals
- Multi-use Systems
- Single-use Systems

Chromatography Resins

Our portfolio of reliable, trusted chromatography solutions has been optimized for your molecule across its entire life cycle, from early-phase development through commercial manufacturing.

Our proven tentacle technology offers a number of advantages compared to conventional resins due to increased accessibility of functional groups and binding of target molecules. This unique feature allows reliable purification and efficiency for our process with high selectivity, excellent yield and purity. We optimized the tentacular surface chemistry of our resins for different applications.

Eshmuno® CP-FT resin

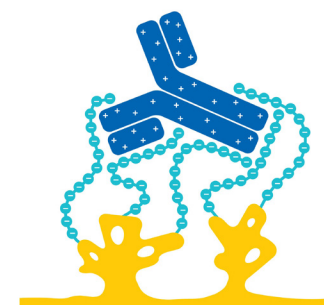

Eshmuno® CPX resin



Eshmuno® CPS resin

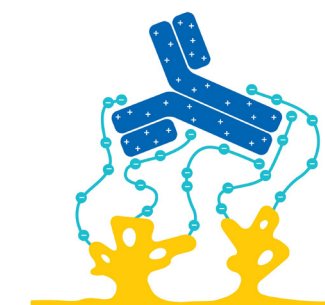

For more information on protein purification products, please visit

[SigmaAldrich.com/safc/bioprocess/purification.html](https://www.sigmaaldrich.com/safc/bioprocess/purification.html)

Synthetic Carbons for Chromatographic Applications

Our portfolio includes many different carbon adsorbents, tailored to meet customer needs. These particles can be designed with:

- The desired shape – either spherical or granular
- No pores, or more or less of the desired pores (micro-, meso-, macro-) to meet the application of interest
- Tapered pores, which increase thermodynamic and kinetic efficiency
- A through-pore or a closed-pore structure, which influences microporous strength and kinetic effectiveness
- Surface pH adjustments, from 2.5 to 10.5

These carbons can be used in gas chromatography (GC), liquid chromatography (LC), solid phase extraction (SPE), and bulk scale applications. A sampling of these carbon particles includes:

Carbosieve™ – These are spherical, non-friable, highly porous particles and used for an analyte size relative to the C2-C5 n-alkanes. These particles have non-tapered pores and very high adsorptive strength. These particles are effective for small, volatile analytes that most adsorbents have trouble retaining.

Carboxen® – These particles are carbon molecular sieves (CMS), much like the carbosieve materials, but include an expanded selection of physical characteristics. Many of the carboxen materials include a combination of micro-, meso-, and macropores to suit customer needs.

Graphsphere™ – Graphsphere™ particles are spherical, graphitized, polymer carbon (SGPC) with a porous or non-porous core, and a graphitized shell of controlled thickness. This shell imparts a variable amount of surface area and capacity. These carbons are used for an analyte size relative to the C5-C12 n-alkanes. Graphsphere™ particles generally have a weaker adsorbent strength as compared to the carbon molecular sieves discussed above.

Carbotrap® and Carbopack™ – These materials are graphitized carbon blacks (GCB) which can be porous or non-porous and are generally granular and friable.

These particles are used for an analyte size relative to C3-C20+ n-alkanes. These also have lower adsorbent strength than the CMS products.

Supel™ Carbon LC – These innovative, porous sub-3 μm particles are used in HPLC applications, and exhibit high pressure stability, elevated temperature stability, unique retention mechanisms, and are compatible with any solvent system. The figure on the next page highlights the repeatability and narrow particle size distribution of this material.

About Supel™ Carbon LC HPLC Particles

Supel™ Carbon LC particles are a fully porous graphitic carbon-based material designed specifically for HPLC and UHPLC applications. Supel™ Carbon LC is the first commercially available sub-3 μm particle. This new, patented, porous graphitic carbon (PGC) exhibits much narrower particle size distributions compared to pre-existing technology, as the plots on the next page indicate. PGC materials are very similar to graphitized carbon blacks (GCBs), but PGC has a spongy structure which is able to withstand the shearing forces occurring in HPLC. As a packing for HPLC, PGC can act as a strong hydrophobic adsorbent behaving similar to reversed-phase (RP) chromatography. However, where PGC differs to RP chromatography is in its ability to retain more polar analytes that tend to elute too early by RP. In addition, planar (especially aromatic) compounds due to their shape have intense interactions with the surface resulting in strong retention as consequence of the graphitic nature of the particles. There are no alkyl ligands off the support, but rather the top layer has flat, hexagonally arranged carbon atoms that are all covalently bonded to three carbon atoms. The remaining electron on each carbon, needed for bonding, is transposed perpendicular to the plane in p-orbitals which subsequently hybridize together to form a continuous pi orbital allowing the delocalized electrons to freely roam across the plane. For chromatography, this “sea” of electrons is believed to allow for electrostatic interactions with the pi-cloud of graphite.

Particle size distribution of Supel™ Carbon LC HPLC lots vs. Competitor

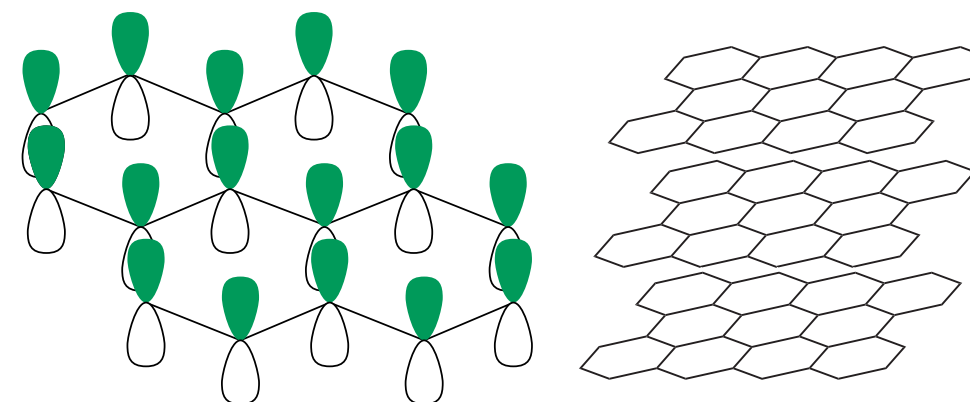
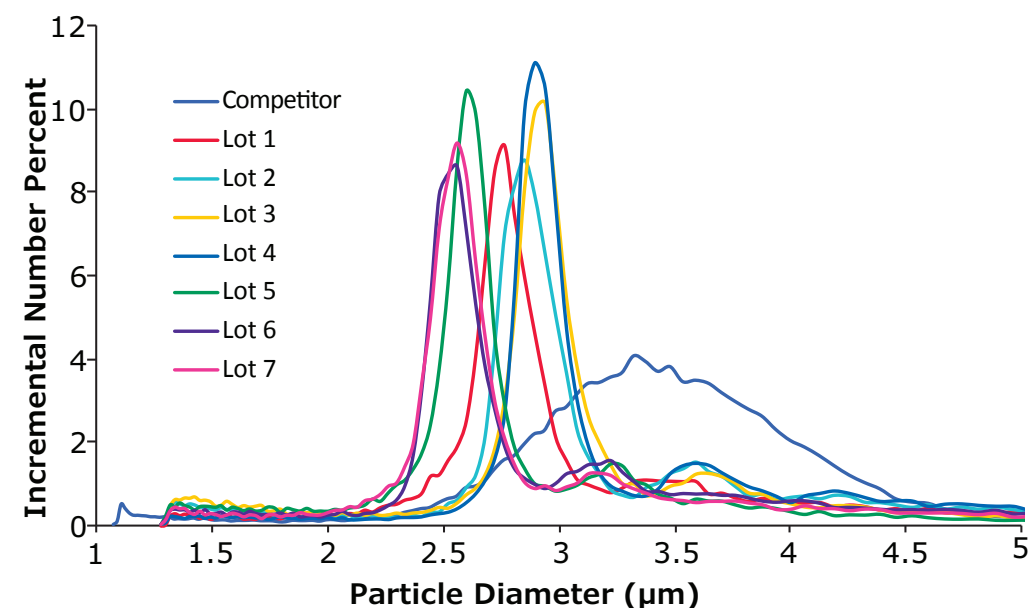

(Right) Simplified view of graphite (Left) P-orbitals on a section of graphite. This quality gives the surface not only conductive properties, but also the ability for electronic interactions at the surface

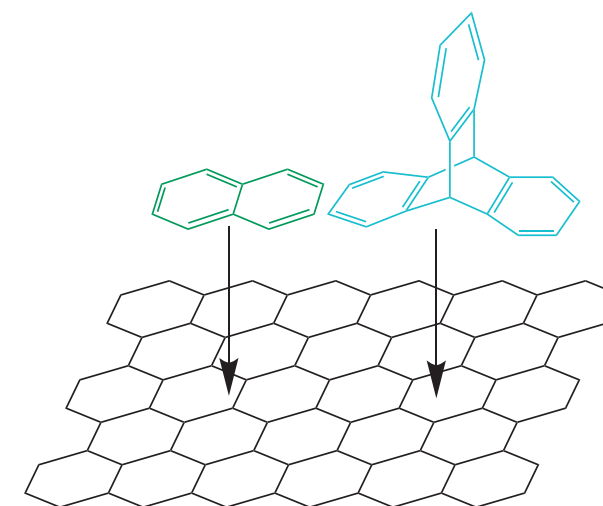

An example of compound alignment with the graphitic surface. Left: Naphthalene is planar and can align well against the graphitic plane. Right: Triptycene is rigid and not able to align completely flat against the surface. This better alignment of naphthalene results in a stronger interaction with the surface and increased retention.

Supel™ Carbon LC HPLC Columns

Porous graphitic carbon (PGC) particles, designed by a unique and patented synthetic process, constitute the packing of Supel™ Carbon LC U/HPLC columns. The key advantages of using PGC columns over silica particle-packed columns include:

Elevated Temperature Stability: Columns can be readily operated at temperatures up to 250 °C, thereby allowing faster and more efficient separations.

pH Stability: Compatible with mobile phases in the pH range of 1 – 14 at any temperature without causing a decline in the column lifespan.

Unique Retention Mechanism: The Polar Retention Effect on Graphite (PREG) mechanism allows for the retention of polar or charged compounds without hydrophilic interaction liquid chromatography (HILIC) conditions. The mechanism also allows the resolution of geometric isomers.

Compatibility with Any Solvent: Any polar or non-polar solvent can be used for the resolution of an analyte of interest.

Pressure Stability up to 700 bar.

Supel™ Carbon LC Specifications

Phase Bonding	Bonding Chemistry	Particle Size (µm)	Pore Size (Å)	Surface Area (m ² /g)	pH Stability	Max Temperature	Endcapped	Shipping Solvent
N/A (porous graphitic carbon)	N/A	2.7	200	155	1 to 14	250 °C	No	Acetonitrile/Water

Peaks	Compound	Ret. Time (min)
1	3-epi-25-hydroxyvitamin D3 (50 µg/mL)	8.294
2	25-hydroxyvitamin D3 (25 µg/mL)	9.125
3	3-epi-25-hydroxyvitamin D2 (50 µg/mL)	11.126
4	25-hydroxyvitamin D2 (100 µg/mL)	12.052

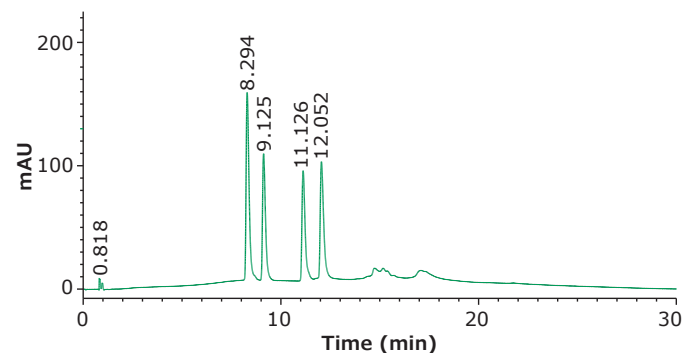

Chromatographic separation of Vitamin D2 and D3 metabolites on Supel™ Carbon LC

Chromatographic Conditions

Column:	Supel™ Carbon LC, 10 cm x 2.1 mm I.D., 2.7 µm
Mobile phase:	[A] 2-Propanol; [B] Tetrahydrofuran
Gradient	0% B to 70% B in 15 min; hold at 70% B for 5 min
Flow rate:	0.3 mL/min
Column temp.:	25 °C
Detector:	UV, 275 nm
Injection:	2.0 µL
Sample:	Vitamin D2 and D3 metabolites mix, varied concentration in ethanol

Supel™ Carbon LC column - 20 Underivatized Amino Acids

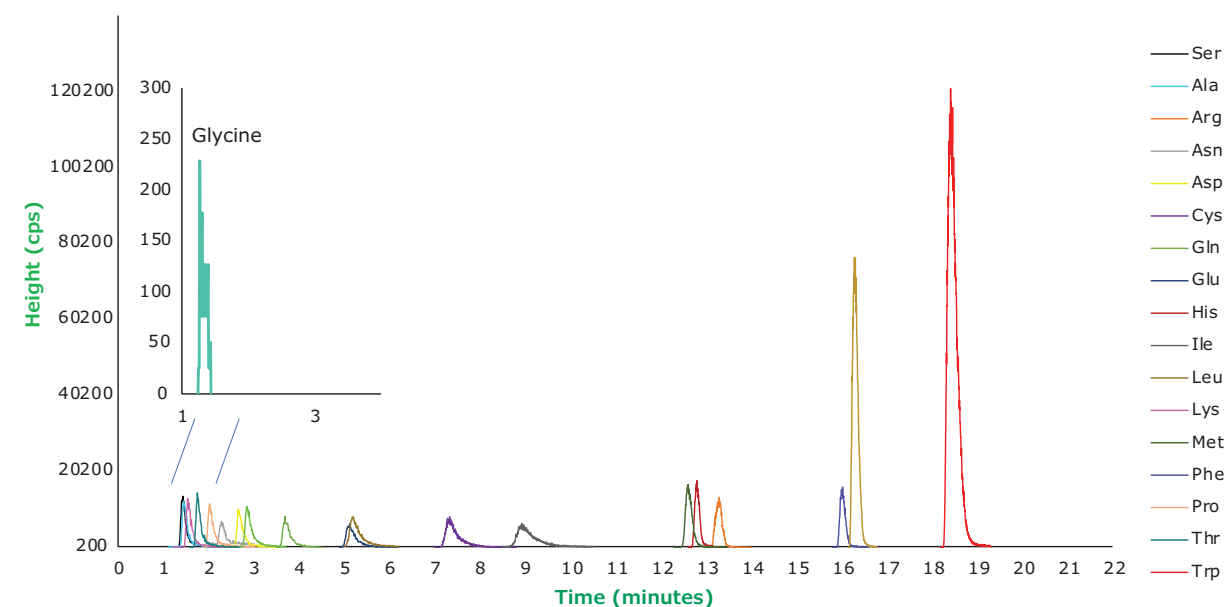

Separation of 20 underivatized amino acids by LC-MS/MS. Conditions: Column: Supel™ Carbon LC, 10 cm x 2.1 mm I.D., 2.7 µm; Mobile Phase: [A] Water (0.1% (v/v) DFA); [B] Acetonitrile (0.1% (v/v) DFA); Gradient: Hold at 0% B for 7 min; 0% B to 5% B in 5 min; 5% B to 100% B in 10 min; Flow Rate: 0.2 mL/min; Column temp.: 12 °C; Detector: MSD; Injection: 1.0 µL; Sample: Amino Acid Mix, varied concentration, water (0.1% (v/v) DFA)

Elution Order	Compound	Retention Time (min)
1	Glycine	1.27
2	Serine	1.43
3	Alanine	1.45
4	Lysine	1.54
5	Threonine	1.75
6	Proline	2.03
7	Asparagine	2.29
8	Aspartic Acid	2.65
9	Valine	2.85
10	Glutamine	3.69

Elution Order	Compound	Retention Time (min)
11	Glutamic Acid	5.13
12	Leucine	5.18
13	Cystine	7.34
14	Isoleucine	8.93
15	Methionine	12.61
16	Histidine	12.81
17	Arginine	13.30
18	Phenylalanine	16.03
19	Tyrosine	16.29
20	Tryptophan	18.42

Supel™ Carbon LC

Length (mm)	I.D. (mm)	SKU
50	x 2.1	59984-U
100	x 2.1	59986-U
150	x 2.1	59987-U
50	x 3.0	59991-U
100	x 3.0	59993-U
150	x 3.0	59994-U
50	x 4.6	59997-U
100	x 4.6	59998-U
Guard 3pk	x 2.1	59981-U
Guard 3pk	x 3.0	59988-U
Guard 3pk	x 4.0	59995-U
Guard Kit	x 2.1	59982-U
Guard Kit	x 3.0	59989-U
Guard Kit	x 4.0	59996-U
Guard Holder	x N/A	59999-U

Special HPLC phases

Polymeric particles, Zirconia and Alumina

apHera™ HPLC Columns

apHera™ reversed phase columns were developed specifically to provide the superior advantages of both silica and polystyrene columns, without the disadvantages of either. This trait was accomplished using a vinyl alcohol copolymer base that keeps the surface wetted even with high carbon loads. The columns are packed with butyl (C4), octyl (C8) or octadecyl (C18) packings obtained by the introduction of the alkyl function on the hydroxyl groups of vinyl alcohol copolymers. The porous structure has an average pore diameter large enough to produce ideal results for small analytes, peptides and small proteins. These columns equal silica-based columns in separation efficiency with organic solvents but provide efficiency with buffered and alkaline solutions not possible on silica. Shrinkage and swelling are minimal in a broad range of solvents, and the high NTP values of these columns are practically unaffected by differing solvent polarities, unlike polystyrene based polymer columns. One of the most significant features is the logical elution order of alkylated bases where retention increases proportionately with increasing chain length.

apHera™ amino columns are based on covalently bonded polyamine specifically optimized for the separation of mono- and oligosaccharides. The elution order mono-, di-, tri-saccharide shows increased elution volume with increased acetonitrile concentration and complete stability for both acidic and alkaline eluates. The small, robust PVA copolymer bead provides mechanical and chemical strength as well as high column efficiency. Conventional amino columns based on silica do not show long column life, perhaps due to hydrolysis of the silica particle by the basic

amino group. Since apHera™ uses a strong alkaline compatible polymer, these problems are eliminated. Stable retention time and long column lifetime are also characteristics of the column.

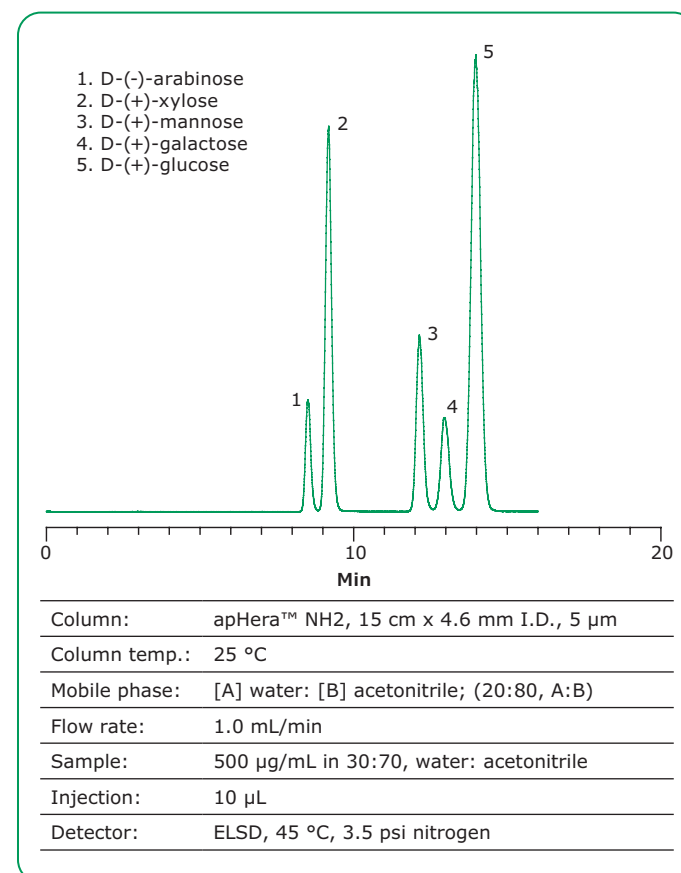

apHera™ (5.0 µm)

Length (mm)	I.D. (mm)	C18	C8	C4	NH2
150	x 2.0	56100AST			56400AST
150	x 4.6	56102AST	56202AST	56302AST	56401AST
250	x 4.6	56103AST		56303AST	56403AST
250	x 10.0		56208AST	56308AST	56408AST
Guard 10	x 2.0	56129AST			56429AST
Guard 10	x 4.6	56130AST	56230AST		56430AST
Guard 50	x 7.5			56332AST	

Discovery® Zr Zirconia HPLC columns

Discovery® Zr HPLC columns consists of spherical, porous zirconia particles allowing the use of the full range of mobile phase pH from pH 1 to 13. Discovery® Zr HPLC columns are available with different coatings:

Discovery® Zr-PBD: with a durable coating of polybutadiene. It operates via reversed-phase and ion-exchange modes.

Discovery® Zr-PS: with cross-linked polystyrene. It operates via reversed-phase and ion-exchange modes. Because it is weakly hydrophobic, it can be used with 100% aqueous mobile phases. It has unique selectivity especially for aromatic compounds.

Discovery® Zr-Carbon with carbon-coating. It is ideal for the reversed-phase separation of positional isomers, diastereomers, and many other compounds.

Discovery® Zr-CarbonC18 with carbon-clad covalently modified with octadecyl (C18) groups. It is intended for the reversed-phase separation of acidic and neutral compounds.

Discovery® Zr (3.0 µm)

Length (mm)	I.D. (mm)	PBD	PS	Carbon	Carbon-C18
50	x 2.1			65725-U	
75	x 2.1				65702-U
150	x 2.1				65703-U
50	x 4.6		65740-U		
150	x 4.6	65718-U	65742-U	65730-U	65706-U

Discovery® Zr (5.0 µm)

Length (mm)	I.D. (mm)	PBD	PS	Carbon	Carbon-C18
150	x 2.1	65720-U	65744-U	65732-U	
150	x 4.6	65723-U		65735-U	
Guard Kit	x 2.1				65805-U
Guard Kit	4.0			65828-U	

Aluspher® RP select B Alkaline stable HPLC separations

Due to its stability, alumina, together with alkaline eluents, has enabled new applications to be found for HPLC. Advanced formulation techniques permit the production of spherical alumina particles as a base for Aluspher® 100 RP-select B.

Aluspher® 100 RP-select B is ideal for use with basic eluents, as ionization of basic compounds is suppressed and peak-tailing is avoided. Due to its stability in the range of pH 2-12, Aluspher® 100 RP-select B permits the use of basic eluents such as NaOH for the separation of neutral, basic and acidic compounds.

Aluspher®

Phase Bonding	USP Designation	Bonding Chemistry	Particle Size (µm)	Pore Size (Å)	Surface Area (m ² /g)	pH Stability	Max Temperature	Encapped	Shipping Solvent
RP-Select B	L7	Alumina particles, coated with polybutadiene (PBD)	5	100	170	2-12	60	No	Acetonitrile/Water

Aluspher® LiChroCART® HPLC Cartridge

Column dimension		
Length (mm)	I.D. (mm)	RP-select B
LiChroCART® HPLC Cartridge [1 unit]		
125	x 4	1.51315.0001
250	x 4	1.51318.0001

The LiChroCART® columns (75, 100, 125, 150 and 250 mm length) in the list above (2, 3, 4 and 4.6 mm I.D.) require part number [1.51486.0001](#) manu-CART® cartridge column holder, which can be used to hold one cartridge column with or without a 4-4 mm guard column.

Customized packings

On top of the very extensive column assortment Supelco® offers, customized packed columns for highest flexibility and professional solutions are available. The sorbents and the packed HPLC columns are tested before delivering. Each finished column is provided with a Certificate of Analysis.

Easy Ordering: Please combine the ordering number of the column hardware (LiChroCART®, Hibar® RT or Hibar® HR) and the sorbent number:

Example: Customized packing ordering number of Hibar® RT 250-4.6 1.00424.
 Sorbent Number of Purospher™ STAR Si, 5 µm 7180
 Ordering Number of Hibar® RT 250-4.6 Purospher™ STAR Si, 5 µm 1.00424.7180

Length (mm)	I.D. (mm)	LiChroCART®	Hibar® RT	Hibar® HR
30	x 2	150229		
50	x 2		151928	
55	x 2	150234		
100	x 2	151939	151929	
125	x 2	150195	151930	
150	x 2	151940	151931	
250	x 2	150190	151932	
30	x 2.1			151934
50	x 2.1			151935
100	x 2.1			151936
150	x 2.1			151937
250	x 2.1			151938
30	x 3	150233		
50	x 3		151923	
55	x 3	150236		
100	x 3	151941	151924	
125	x 3	150175	151925	
150	x 3	151942	151926	
250	x 3	150177	100423	
300	x 3.9	151943	151933	

Length (mm)	I.D. (mm)	LiChroCART®	Hibar® RT	Hibar® HR
25	x 4	150172		
30	x 4	150302	151196	
50	x 4		151927	
55	x 4	150228		
75	x 4	150171		
125	x 4	150170	150181	
250	x 4	150174	150182	
100	x 4.6	151448	150013	
125	x 4.6	151442	150012	
150	x 4.6	151432	150009	
250	x 4.6	151431	100424	
75	x 10	151449		
100	x 10	151445		
125	x 10	151443		
150	x 10	151444		
250	x 10	150179	150183	
75	x 25		151449	
Guard Cartridge				
10	x 2	150201		
4	x 4	150173		
10	x 10	150178		

Sorbent Code	Packing Material
Purospher™ STAR	
7174	Purospher™ STAR SI 3µm
7175	Purospher™ STAR SI 5µm
7177	Purospher™ STAR NH2 5µm
7184	Purospher™ STAR RP-18e 3µm
7185	Purospher™ STAR RP-18e 5µm
7194	Purospher™ STAR RP-8e 5µm
7220	Purospher™ STAR RP-8e 3µm
7232	Purospher™ STAR Phenyl 2µm
7234	Purospher™ STAR Phenyl 3µm
7235	Purospher™ STAR Phenyl 5µm
7236	Purospher™ STAR RP-18e 2µm
7237	Purospher™ STAR RP-8e 2µm
Purospher™	
7127	Purospher™ RP-18 5µm
7130	Purospher™ RP-18e 5µm
7180	Purospher™ Si 5µm

Sorbent Code	Packing Material
Superspher®	
7137	Superspher® 100 RP-18 4 µm
7138	Superspher® 100 RP-18e 4 µm
7139	Superspher® 60 RP-8 4 µm
7140	Superspher® 60 RP-8e 4 µm
7141	Superspher® 60 RP select B 4 µm
7142	Superspher® 60 Si 4 µm
7143	Superspher® 100 Si 4 µm
LiChrospher®	
7070	LiChrospher® 100 CN 10µm
7071	LiChrospher® 100 CN 5µm
7075	LiChrospher® 100 DIOL 5µm
7076	LiChrospher® 100 NH2 5µm
7077	LiChrospher® 100 NH2 10µm
7078	LiChrospher® PAH 5µm
7079	LiChrospher® 100 RP-18 5µm
7081	LiChrospher® 100 RP-18 10µm

Sorbent Code	Packing Material
7084	LiChrospher® 100 RP-18e 10µm
7085	LiChrospher® 100 RP-18e 5µm
7087	LiChrospher® 100 RP-8 5µm
7088	LiChrospher® 100 RP-8 10µm
7091	LiChrospher® 100 RP-8e 10µm
7092	LiChrospher® 100 RP-8e 5µm
7093	LiChrospher® 60 RP select B 5µm
7094	LiChrospher® 60 RP select B, 10 µm
7104	LiChrospher® 60 Si 10µm
7109	LiChrospher® 60 Si 5µm
ChiraDex®	
7004	ChiraDex® 5µm
7222	ChiraDex® HR 5µm
Aluspher®	
7002	Aluspher® 100 RP-select B, 5µm

Custom Column requests for Ascentis® Express and BIOshell™ Fused-Core® HPLC and UHPLC Columns, Discovery®, Discovery® BIO, Ascentis®, SUPELCOSIL™, CHIROBIOTIC®, CYCLOBOND™ Fully porous silica particulate HPLC columns and Titan™ UHPLC columns as well as Supel™ Carbon LC Carbon U/HPLC columns, can be submitted through our Customer Service or on our web page.

[Custom HPLC Column Request](#)

Supelco®

Analytical Products

MilliporeSigma
400 Summit Drive
Burlington, MA 01803

[SigmaAldrich.com/HPLC](https://www.sigmaaldrich.com/HPLC)

To place an order or receive technical assistance:

Order/Customer Service: **[SigmaAldrich.com/order](https://www.sigmaaldrich.com/order)**

Technical Service: **[SigmaAldrich.com/techservice](https://www.sigmaaldrich.com/techservice)**

Safety-related Information: **[SigmaAldrich.com/safetycenter](https://www.sigmaaldrich.com/safetycenter)**

© 2022 Merck KGaA, Darmstadt, Germany and/or its affiliates. All Rights Reserved. MilliporeSigma, the vibrant M, and Supelco, Supel, SUPELCOSIL, LiChrospher, Discovery, Ascentis, SeQuant, Purospher, BIOshell, Eshmun, Chromolith, Astec, CHIROBIOTIC, CYCLOBOND, ChiraDex, LiChrosorb, SUPERSPHER, apHera, SUPELCOGEL, Samplicity, Millex, Pelliguard, Supelclean, Suplex, Supelguard, SiLu, LiChroSolv, Carbosieve, Carboxen, Graphsphere, Carbotrap, Carbopack, Titan, manu-CART, LiChroCART, Hibar, CapRod, ZIC, and Aluspher are trademarks of Merck KGaA, Darmstadt, Germany or its affiliates. All other trademarks are the property of their respective owners. Detailed information on trademarks is available via publicly accessible resources.

MS_BR7614EN Ver. 2.0
40190
05/2022